

B BRADO
ITALY 1976

SISTEMA DI CODIFICA CODING SYSTEM

MOVIMENTO / MOVEMENT

- G girevole 360° / *swivel 360°*
- A autoallineante / *auto-return*
- F fisso / *fix*

TIPO AGGANCIAMENTO / HOOK SYSTEM

- S standard
- A automatico / *automatic*

KYLIE

KYPI-AAP-S

BASE

- PI piramidale / *pyramidal*
- 4P 4 razze mini / *4 stars mini*
- 4G 4 razze maxi / *4 stars maxi*
- 5P 5 razze mini / *5 stars mini*
- 5G 5 razze maxi / *5 stars maxi*

SUPPORTO / SUPPORT

- A alto / *high*
- M medio / *medium*
- B basso / *low*
- G alzata a gas / *gas lift*

VERSIONE / VERSION

- P piedini / *glides*
- R ruote / *castors*

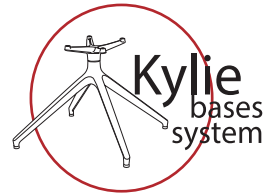

SISTEMA BASI KYLIE

Gamma completa di basamenti in alluminio.

Basi piramidali, 4 razze o 5 razze in 2 misure; sviluppate per rispondere a tutte le esigenze di organizzazione degli spazi.

Adatta per sedute contract ed ufficio, la famiglia Kylie si contraddistingue per l'ampia versatilità grazie alle numerose configurazioni in varie altezze.

Supporti interasse standard 153mm x 200mm, basi con foro di alloggiamento diametro 50mm. Perni per ruote o piedini diametro 11mm.

Tutti i supporti sono disponibili anche con agganci automatici, compatibili con la maggior parte delle scocche Brado Contract.

KYLIE BASES SYSTEM

Aluminium bases complete range.

Pyramidal, 4 and 5 stars available in 2 dimensions; developed to meet all the spacial requirements.

Thanks to the wide range of configurations in different heights, the Kylie family is a excellent solution for contract and office chairs.

Standard fixing points 153mm x 200mm, bases with housing diameter 50mm. Castors or glides pins diameter 11mm.

All supports available also with automatic hooks, suitable for use with the majority of Brado Contract shells.

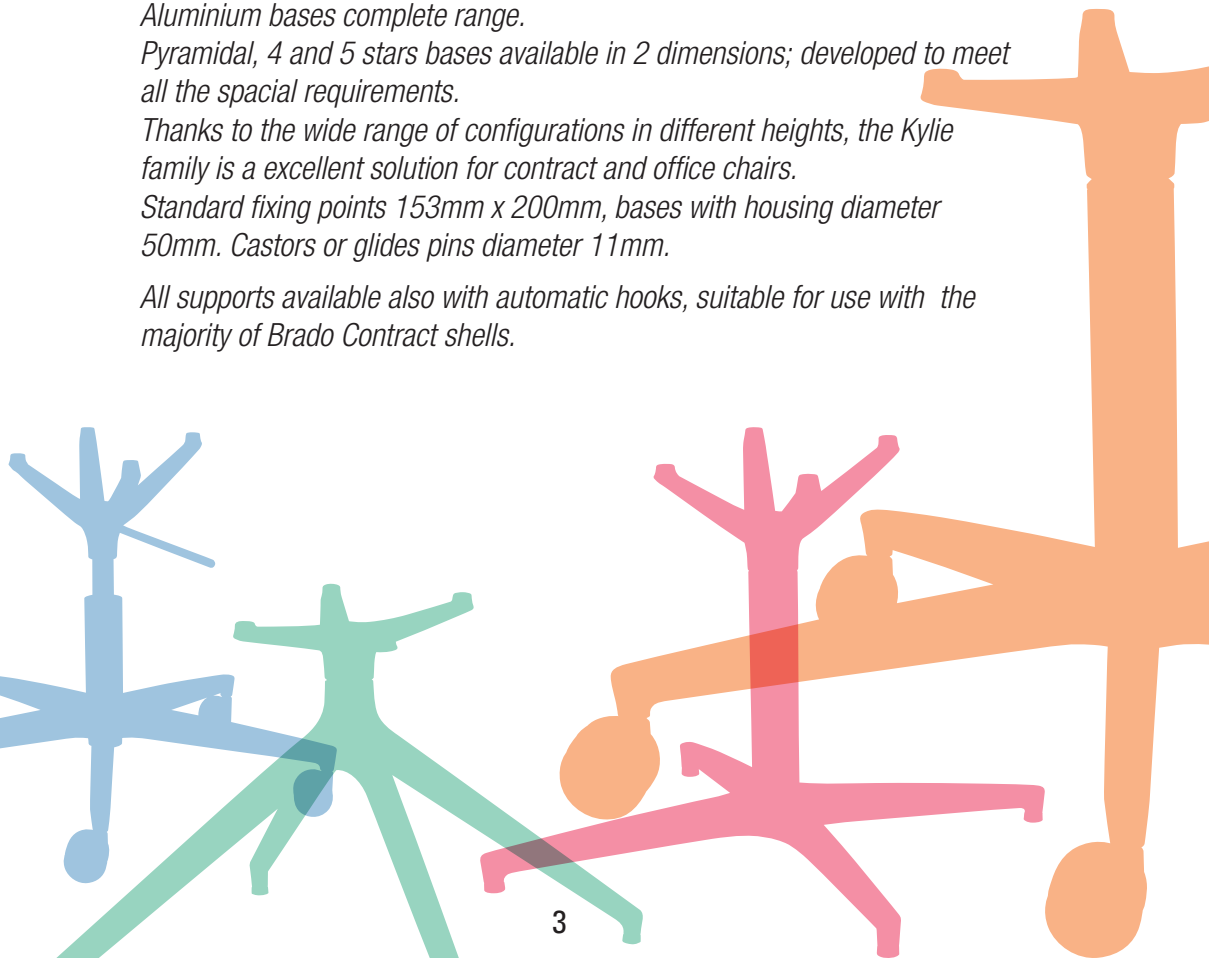



KYPI-GAP-S
 Base piramidale,
 supporto alto, girevole 360°,
 con piedini, H totale 440

*Pyramidal base,
 high support, swivel 360°,
 with glides, total H 440*

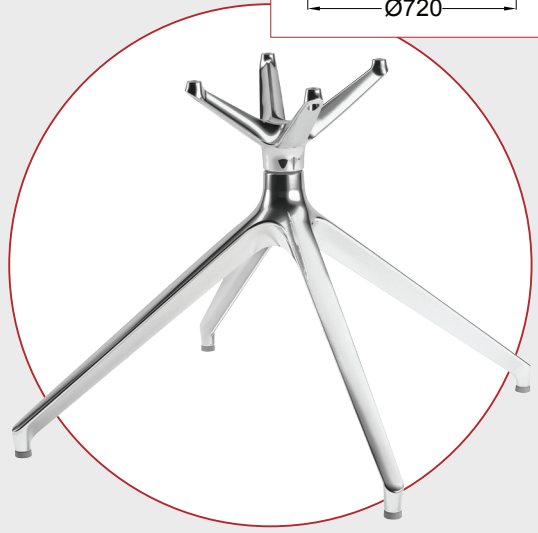
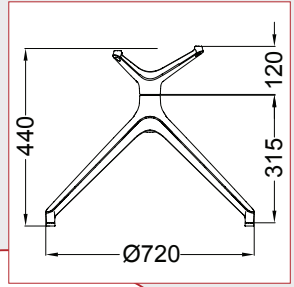

KYPI-AAP-S

Base piramidale,
 supporto alto con
 autoallineante, con piedini,
 H totale 440

*Pyramidal base,
 high support with
 auto-return, with glides,
 total H 440*

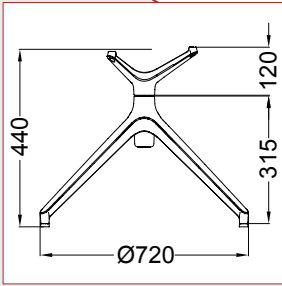

KYPI-GMP-S
 Base piramidale,
 supporto medio, girevole 360°,
 con piedini, H totale 415

*Pyramidal base,
 medium support, swivel 360°,
 with glides, total H 415*

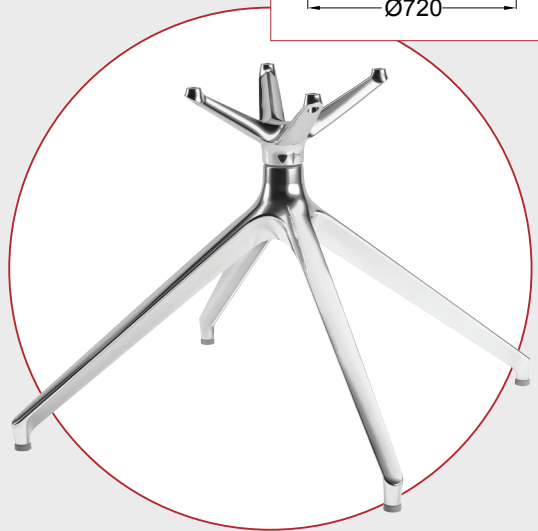
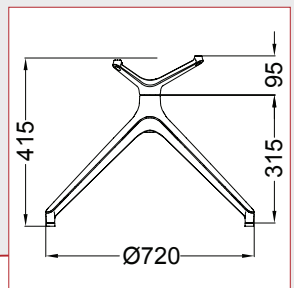

KYPI-AMP-S

Base piramidale,
 supporto medio con
 autoallineante, con piedini,
 H totale 415

*Pyramidal base,
 medium support with
 auto-return, with glides,
 total H 415*

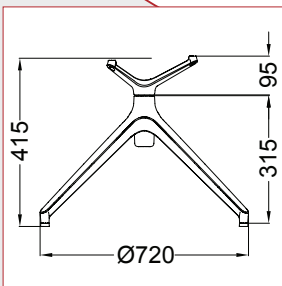



KYPI-GBP-S

Base piramidale,
supporto basso, girevole 360°,
con piedini, H totale 395

*Pyramidal base,
low support, swivel 360°,
with glides, total H 395*

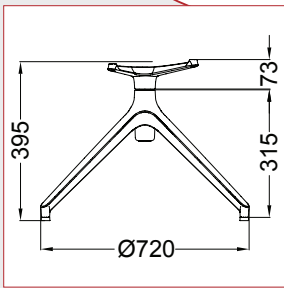
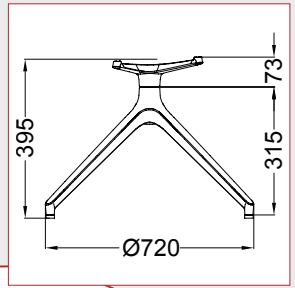

KYPI-ABP-S

Base piramidale,
supporto basso con
autoallineante, con piedini,
H totale 395

*Pyramidal base,
low support with auto-return,
with glides, total H 395*

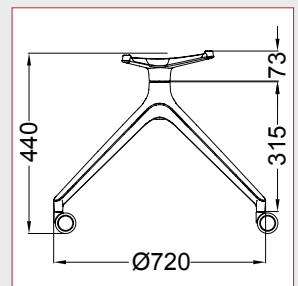







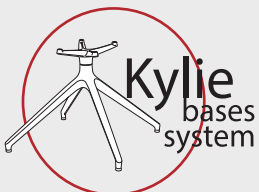

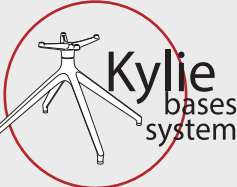





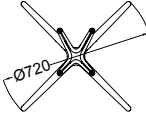

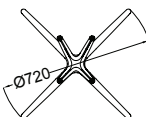

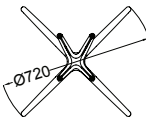

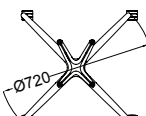
KYPI-FBR-S

Base piramidale,
supporto basso, adattatore fisso,
con ruote, H totale 440

*Pyramidal base,
low support, fixed adaptor,
with castors, total H 440*



		BAM07501AL	ACM267FZA	ACM267FZB	ACM267FZC	ACY268GH
						
KYPI-AAP-S (auto-return)	 	x1	x1			x1
		x1		x1		
KYPI-GAP-S (360° swivel)						
KYPI-AMP-S (auto-return)	 	x1	x1			x1
		x1		x1		
KYPI-GMP-S (360° swivel)						
KYPI-ABP-S (auto-return)	 	x1	x1			x1
		x1		x1		
KYPI-GBP-S (360° swivel)						
KYPI-FBR-S (fix)	 	x1			x1	

ACY299GH	PSM13713AL	PSM13513AL	PSM13913AL	RUP0131NR	PDY006AGH	PDT006
VTM0620PSBFB						
	x1				x4	OPTIONABLE FOR PDY006AGH x4
x1	x1				x4	OPTIONABLE FOR PDY006AGH x4
		x1			x4	OPTIONABLE FOR PDY006AGH x4
x1		x1			x4	OPTIONABLE FOR PDY006AGH x4
			x1		x4	OPTIONABLE FOR PDY006AGH x4
x1			x1		x4	OPTIONABLE FOR PDY006AGH x4
x1			x1	x4		

* Disponibile con agganci automatici / Available with automatic hooks

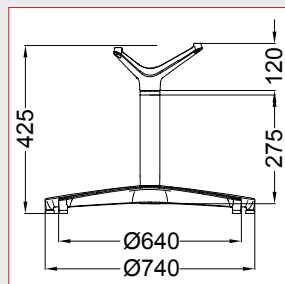
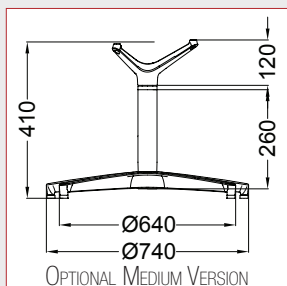

KY4P-AAP-S

Base 4 razze mini, supporto alto con autoallineante, colonna H 275, con piedini, H totale 425

4 stars mini base, high support with auto-return, column H 275, with glides, total H 425

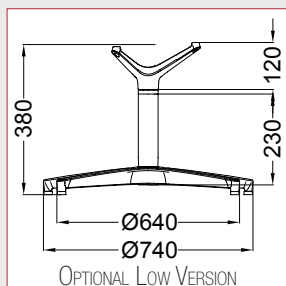

KY4G-AAP-S

Base 4 razze maxi, supporto alto con autoallineante, colonna H 275, con piedini, H totale 425

4 stars maxi base, high support with auto-return, column H 275, with glides, total H 425

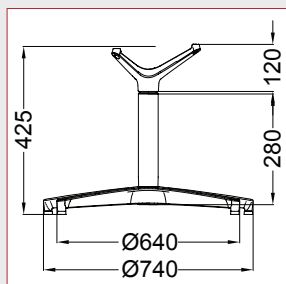

KY4P-GAP-S

Base 4 razze mini, supporto alto, girevole 360°, colonna H 280, con piedini, H totale 425

4 stars mini base, high support, swivel 360°, column H 280, with glides, total H 425

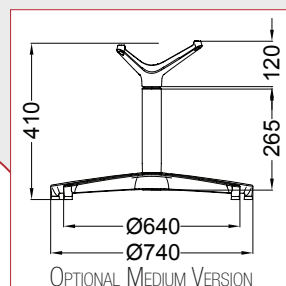

KY4G-GAP-S

Base 4 razze maxi, supporto alto, girevole 360°, colonna H 280, con piedini, H totale 425

4 stars maxi base, high support, swivel 360°, column H 280, with glides, total H 425

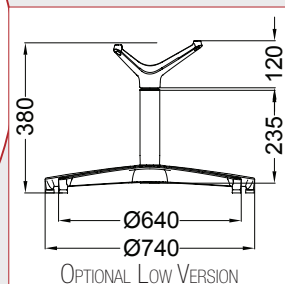

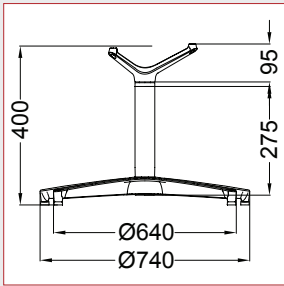

KY4P-AMP-S

Base 4 razze mini, supporto medio con autoallineante, colonna H 275, con piedini, H totale 400

4 stars mini base, medium support with auto-return, column H 275, with glides, total H 400

KY4G-AMP-S

Base 4 razze maxi, supporto medio con autoallineante, colonna H 275, con piedini, H totale 400

4 stars maxi base, medium support with auto-return, column H 275, with glides, total H 400

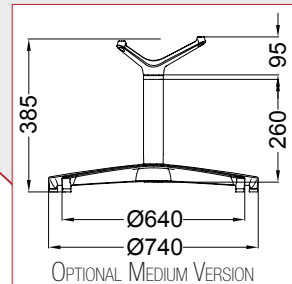
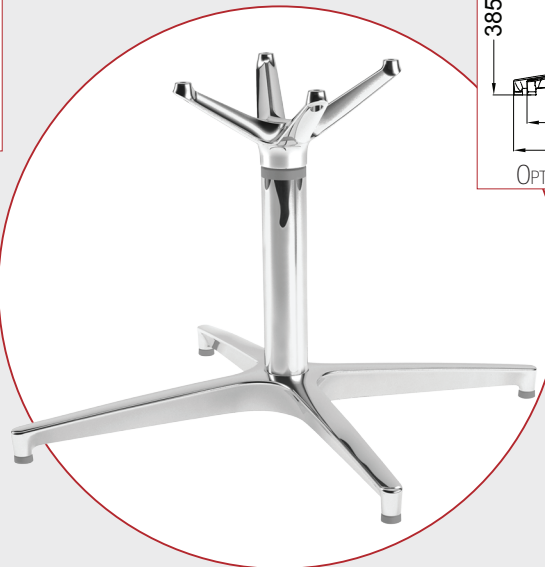

OPTIONAL MEDIUM VERSION

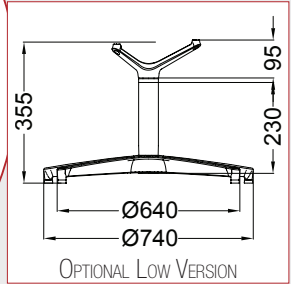

OPTIONAL LOW VERSION

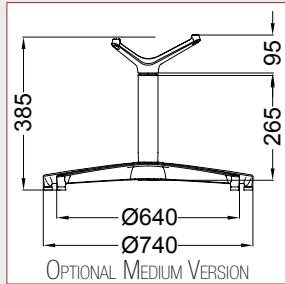

OPTIONAL MEDIUM VERSION

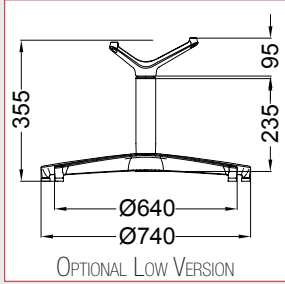

OPTIONAL LOW VERSION

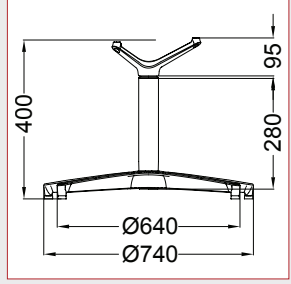
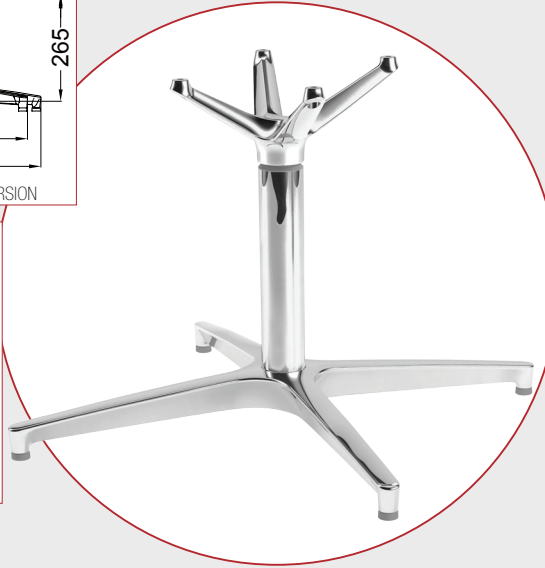

KY4P-GMP-S

Base 4 razze mini, supporto medio, girevole 360°, colonna H 280, con piedini, H totale 400









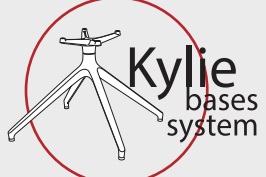

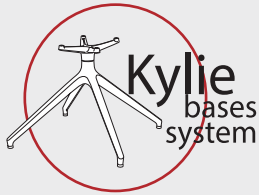

4 stars mini base, medium support, swivel 360°, column H 280, with glides, total H 400



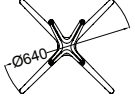
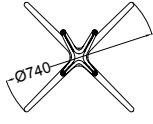

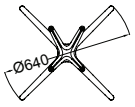
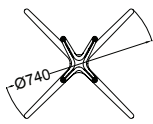

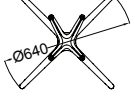
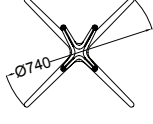
KY4G-GMP-S

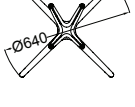
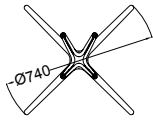
Base 4 razze maxi, supporto medio, girevole 360°, colonna H 280, con piedini, H totale 400

4 stars maxi base, medium support, swivel 360°, column H 280, with glides, total H 400



		BAM07601AL	BAM07701AL	ACM278FC	ACM312FC	ACM279FC
						
KY4P-AAP-S (base mini) 		x1				
			x1			
KY4G-AAP-S (base maxi)						
KY4P-GAP-S (base mini) 		x1		TO REPLACE ACM279FC x1 (H 380)	TO REPLACE ACM279FC x1 (H 410)	x1
			x1	TO REPLACE ACM279FC x1 (H 380)	TO REPLACE ACM279FC x1 (H 410)	x1
KY4G-GAP-S (base maxi)						
KY4P-AMP-S (base mini) 		x1				
			x1			
KY4G-AMP-S (base maxi)						
KY4P-GMP-S (base mini) 		x1		TO REPLACE ACM279FC x1 (H 355)	TO REPLACE ACM279FC x1 (H 385)	x1
			x1	TO REPLACE ACM279FC x1 (H 355)	TO REPLACE ACM279FC x1 (H 385)	x1
KY4G-GMP-S (base maxi)						

ACM281FC	ACM313FC	ACM282FC	PSM13713AL	PSM13513AL	PDY006AGH	PDT006
			 *	 *		
TO REPLACE ACM282FC x1 (H 380)	TO REPLACE ACM282FC x1 (H 410)	x1	x1		x4	OPTIONABLE FOR PDY006AGH x4
TO REPLACE ACM282FC x1 (H 380)	TO REPLACE ACM282FC x1 (H 410)	x1	x1		x4	OPTIONABLE FOR PDY006AGH x4
			x1		x4	OPTIONABLE FOR PDY006AGH x4
			x1		x4	OPTIONABLE FOR PDY006AGH x4
TO REPLACE ACM282FC x1 (H 355)	TO REPLACE ACM282FC x1 (H 385)	x1		x1	x4	OPTIONABLE FOR PDY006AGH x4
TO REPLACE ACM282FC x1 (H 355)	TO REPLACE ACM282FC x1 (H 385)	x1		x1	x4	OPTIONABLE FOR PDY006AGH x4
				x1	x4	OPTIONABLE FOR PDY006AGH x4
				x1	x4	OPTIONABLE FOR PDY006AGH x4

* Disponibile con agganci automatici / Available with automatic hooks

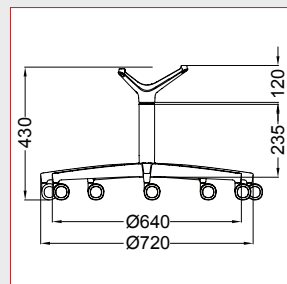

KY5P-GAR-S

Base 5 razze mini,
supporto alto, girevole 360°,
colonna H 235, con ruote,
H totale 430

*5 stars mini base,
high support, swivel 360°,
column H 235, with castors,
total H 430*

KY5G-GAR-S

Base 5 razze maxi,
supporto alto, girevole 360°,
colonna H 235, con ruote,
H totale 430

*5 stars maxi base,
high support, swivel 360°,
column H 235, with castors,
total H 430*

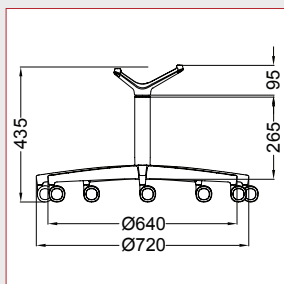

KY5P-GMR-S

Base 5 razze mini,
supporto medio, girevole 360°,
colonna H 265, con ruote,
H totale 435

*5 stars mini base,
medium support, swivel 360°,
column H 265, with castors,
total H 435*

KY5G-GMR-S

Base 5 razze maxi,
supporto medio, girevole 360°,
colonna H 265, con ruote,
H totale 435

*5 stars maxi base,
medium support, swivel 360°,
column H 265, with castors,
total H 435*

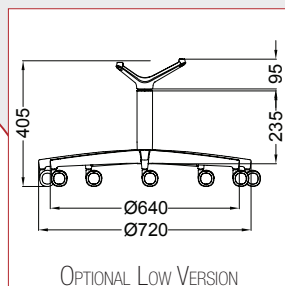
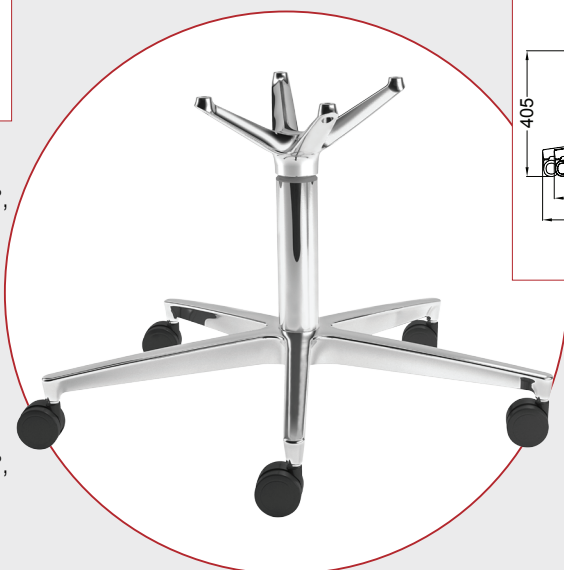

OPTIONAL LOW VERSION

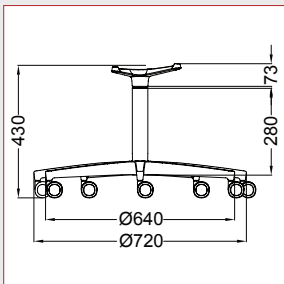

KY5P-GBR-S

Base 5 razze mini,
supporto basso, girevole 360°,
colonna H 280, con ruote,
H totale 430

*5 stars mini base,
low support, swivel 360°,
column H 280, with castors,
total H 430*

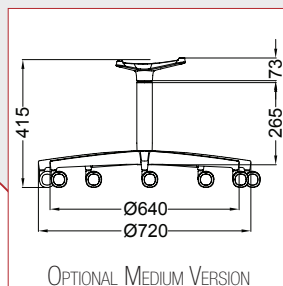

OPTIONAL MEDIUM VERSION

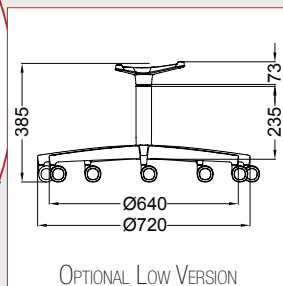

OPTIONAL LOW VERSION

KY5G-GBR-S

Base 5 razze maxi,
supporto basso, girevole 360°,
colonna H 280, con ruote,
H totale 430

*5 stars maxi base,
low support, swivel 360°,
column H 280, with castors,
total H 430*

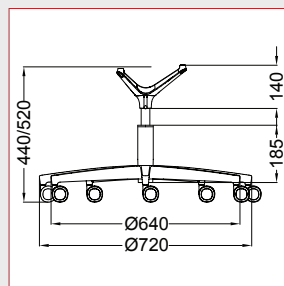

KY5P-GGR-S

Base 5 razze mini,
supporto con leva per
alzata a gas, con ruote,
H totale min440/max520

*5 stars mini base,
support with gas lift lever,
with castors,
total H min440/max520*

KY5G-GGR-S

Base 5 razze maxi,
supporto con leva per
alzata a gas, con ruote,
H totale min440/max520

*5 stars maxi base,
support with gas lift lever,
with castors,
total H min440/max520*

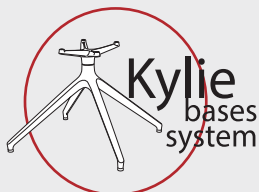

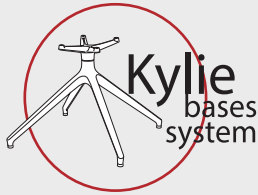

KY5P-GAR-S (base mini)

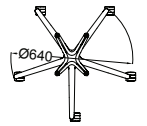

x1

x1

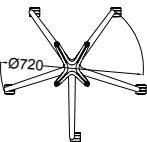

x1

x1

KY5G-GAR-S (base maxi)

KY5P-GMR-S (base mini)

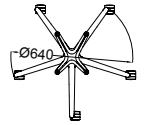

x1

TO REPLACE
ACM312FC x1
(H 405)

x1

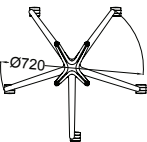

x1

TO REPLACE
ACM312FC x1
(H 405)

x1

KY5G-GMR-S (base maxi)

KY5P-GBR-S (base mini)

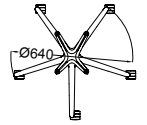

x1

TO REPLACE
ACM279FC x1
(H 385)

TO REPLACE
ACM279FC x1
(H 415)

x1

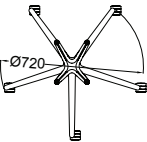

x1

TO REPLACE
ACM279FC x1
(H 385)

TO REPLACE
ACM279FC x1
(H 415)

x1

KY5G-GBR-S (base maxi)

KY5P-GGR-S (base mini)

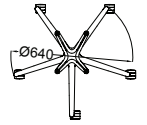



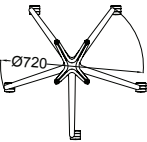





x1



x1

KY5G-GGR-S (base maxi)

ALM90201FC	PSM13613AL	PSM13713AL	PSM13513AL	PSM13913AL	RUP0131NR	PDY006AGH	PDT006
	 *	 *	 *	 *			
		x1			x5	TO REPLACE RUP0131NR x5 (H -45mm)	OPTIONABLE FOR PDY006AGH x5
		x1			x5	TO REPLACE RUP0131NR x5 (H -45mm)	OPTIONABLE FOR PDY006AGH x5
			x1		x5	TO REPLACE RUP0131NR x5 (H -45mm)	OPTIONABLE FOR PDY006AGH x5
			x1		x5	TO REPLACE RUP0131NR x5 (H -45mm)	OPTIONABLE FOR PDY006AGH x5
				x1	x5	TO REPLACE RUP0131NR x5 (H -45mm)	OPTIONABLE FOR PDY006AGH x5
				x1	x5	TO REPLACE RUP0131NR x5 (H -45mm)	OPTIONABLE FOR PDY006AGH x5
x1	x1				x5	TO REPLACE RUP0131NR x5 (H -45mm)	OPTIONABLE FOR PDY006AGH x5
x1	x1				x5	TO REPLACE RUP0131NR x5 (H -45mm)	OPTIONABLE FOR PDY006AGH x5

* Disponibile con agganci automatici / Available with automatic hooks

KYLIE PIRAMIDALE (PYRAMIDAL BASE)

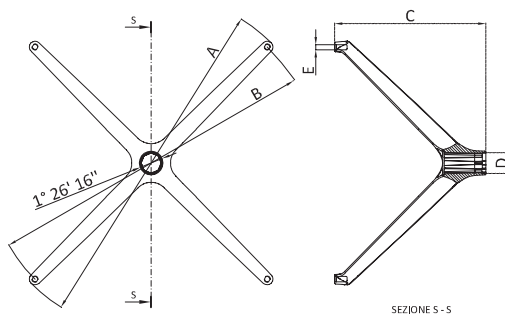

Codice / Code	Descrizione / Description	A	B	C	D	E
BAM07501AL	Base piramidale 4 razze KYLIE, Ø 720mm, alluminio KYLIE 4 stars pyramidal base, Ø 720mm, aluminium	Ø720	Ø695	316	Ø50	Ø11,2

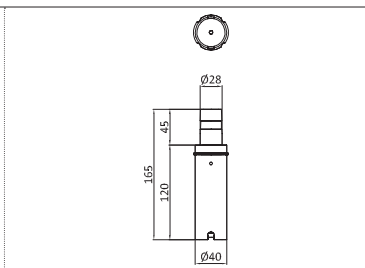

ACM267FZA
Adattatore autoallineante per base KYLIE piramidale, zincato
Auto-return adaptor for pyramidal KYLIE base, zinc-plated

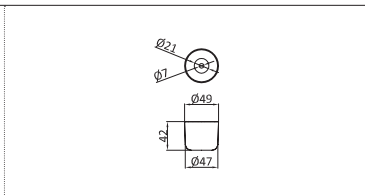

ACY268GH
Cuffia sottobase KYLIE per adattatore autoallineante, in nylon grigio RAL 9022
KYLIE plastic cover for auto-return adaptor, silver RAL 9022

VTM0610PSBZF

Vite TPSEI M6x10mm per ACY268GH, zincata
Screw bevelled hex recess flat head M6x10mm for ACY268GH, zinc-plated

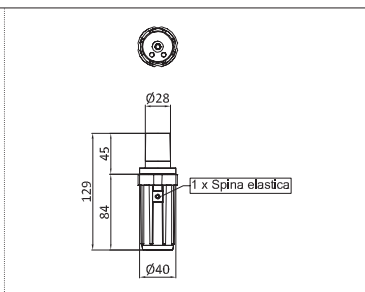

ACM267FZB
Adattatore girevole 360° per base KYLIE piramidale (con una spina), zincato
360° swivel adaptor for pyramidal KYLIE base (with one plug), zinc-plated

ACM267FZC
Adattatore fisso per base KYLIE piramidale (con 1+2 spine), zincato
Fixed adaptor for pyramidal KYLIE base (with 1+2 plugs), zinc-plated

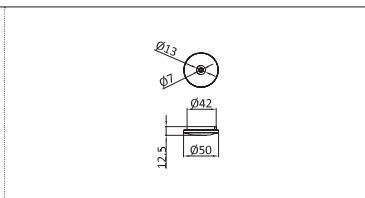

ACY299GH
Tappo sottobase KYLIE per adattatore fisso e 360°, in nylon grigio RAL 9022
KYLIE plastic cover for fixed and swivel adaptor, silver RAL 9022

VTM0620PSBFB

Vite TPSEI M6x20mm per ACY299GH, brunita
Screw bevelled hex recess flat head M6x20mm for ACY299GH, bronzed

KYLIE 4 RAZZE (4 STARS)

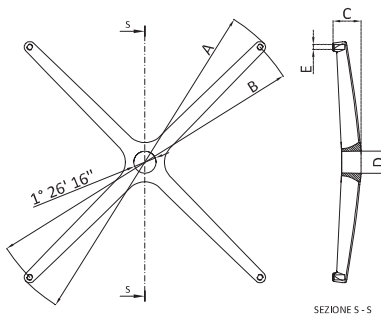

Codice / Code	Descrizione / Description	A	B	C	D	E
BAM07601AL	Base KYLIE 4 razze mini, Ø 640mm, alluminio KYLIE 4 stars mini base, Ø 640mm, aluminium	Ø640	Ø615	62	Ø50	Ø11,2
BAM07701AL	Base KYLIE 4 razze maxi, Ø 740mm, alluminio KYLIE 4 stars maxi base, Ø 740mm, aluminium	Ø740	Ø715	62	Ø50	Ø11,2

KYLIE 5 RAZZE (5 STARS)

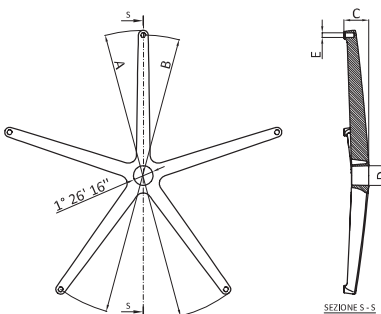

Codice / Code	Descrizione / Description	A	B	C	D	E
BAM07801AL	Base KYLIE 5 razze mini, Ø 640mm, alluminio KYLIE 5 stars mini base, Ø 640mm, aluminium	Ø640	Ø615	62	Ø50	Ø11,2
BAM07901AL	Base KYLIE 5 razze maxi, Ø 720mm, alluminio KYLIE 5 stars maxi base, Ø 720mm, aluminium	Ø720	Ø695	62	Ø50	Ø11,2

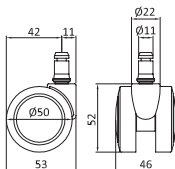

RUP0131NR

Ruota libera Ø 50mm, perno Ø 11mm, nero
Free castor Ø 50mm, pin Ø 11mm, black

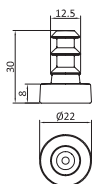

PDY006AGH

Piedino grigio per basamenti KYLIE
Grey glide for KYLIE bases

PDT006

Feltro nero per PDY006AGH (opzione)
Black felt for PDY006AGH (option)

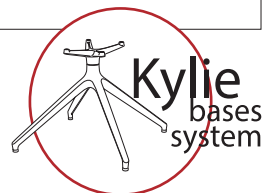

COLONNE AUTOALLINEANTI KYLIE (AUTO-RETURN COLUMNS)

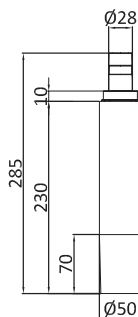

ACM281FC

Colonna girevole autoallineante KYLIE H 230mm,
Ø 50mm, cromata

*KYLIE auto-return swivel column, H 230mm,
Ø 50mm, chromed*

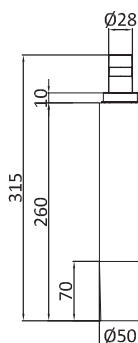

ACM313FC

Colonna girevole autoallineante KYLIE H 260mm,
Ø 50mm, cromata

*KYLIE auto-return swivel column, H 260mm,
Ø 50mm, chromed*

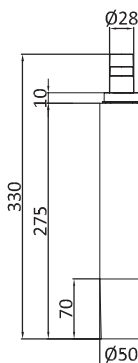

ACM282FC

Colonna girevole autoallineante KYLIE H 275mm,
Ø 50mm, cromata

*KYLIE auto-return swivel column, H 275mm,
Ø 50mm, chromed*

COLONNE 360° KYLIE (360° COLUMNS)

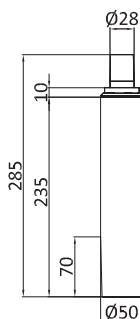

ACM278FC

Colonna girevole 360° KYLIE H 235mm, Ø 50mm, cromata

KYLIE 360° swivel column H 235mm, Ø 50mm, chromed

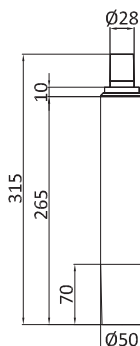

ACM312FC

Colonna girevole 360° KYLIE H 265mm, Ø 50mm, cromata

KYLIE 360° swivel column H 265mm, Ø 50mm, chromed



ACM279FC

Colonna girevole 360° KYLIE H 280mm, Ø 50mm, cromata

KYLIE 360° swivel column H 280mm, Ø 50mm, chromed



SUPPORTI KYLIE (SUPPORTS)

PSM13613AL

Supporto KYLIE con leva per alzata a gas, Ø 35mm, cono Ø 28mm, alluminio
KYLIE support with lever for gas lift, Ø 35mm, cone Ø 28mm, aluminium

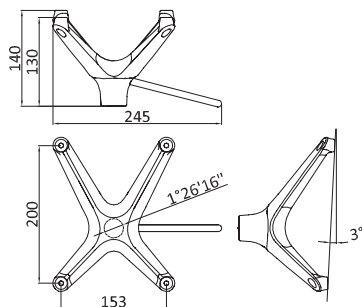

PSM13713AL

Supporto KYLIE alto, Ø 50mm, cono Ø 28mm, alluminio
KYLIE high support, Ø 50mm, cone Ø 28mm, aluminium

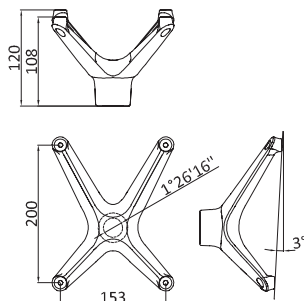

PSM13513AL

Supporto KYLIE medio, Ø 50mm, cono Ø 28mm, alluminio
KYLIE medium support, Ø 50mm, cone Ø 28mm, aluminium

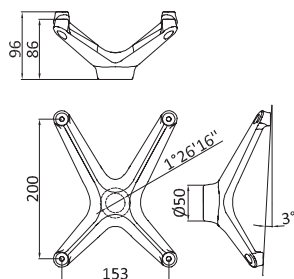

PSM13913AL

Supporto KYLIE basso, Ø 50mm, cono Ø 28mm, alluminio
KYLIE low support, Ø 50mm, cone Ø 28mm, aluminium

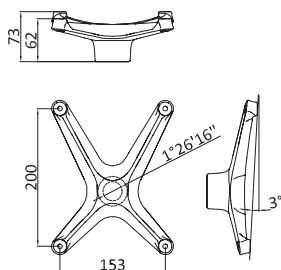

SUPPORTI KYLIE CON AGGANCI AUTOMATICI (SUPPORTS WITH AUTOMATIC HOOKS)

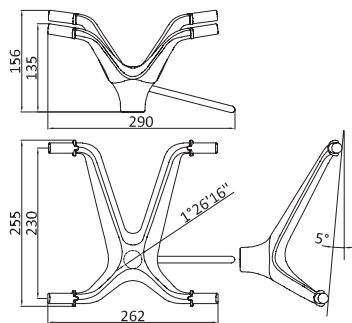

PSM14213AL

Supporto KYLIE con leva per alzata a gas con agganci automatici, Ø 35mm, cono Ø 28mm, alluminio

KYLIE support with lever with automatic hooks for gas lift, Ø 35mm, cone Ø 28mm, aluminium

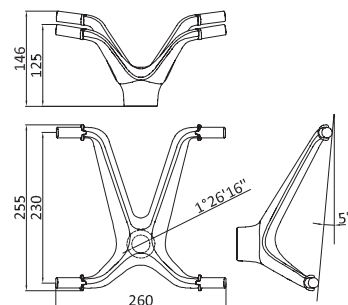

PSM14113AL

Supporto KYLIE alto con agganci automatici, Ø 50mm, cono Ø 28mm, alluminio

KYLIE high support with automatic hooks, Ø 50mm, cone Ø 28mm, aluminium

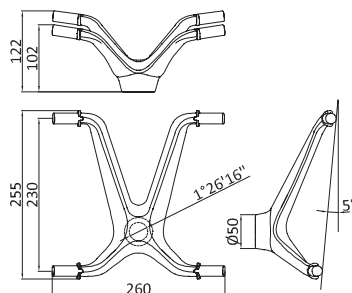

PSM14313AL

Supporto KYLIE medio con agganci automatici, Ø 50mm, cono Ø 28mm, alluminio

KYLIE medium support with automatic hooks, Ø 50mm, cone Ø 28mm, aluminium

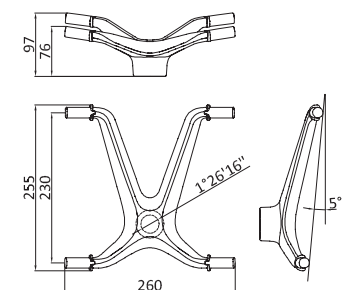

PSM14013AL

Supporto KYLIE basso con agganci automatici, Ø 50mm, cono Ø 28mm, alluminio

KYLIE low support with automatic hooks, Ø 50mm, cone Ø 28mm, aluminium





ESEMPI DI UTILIZZO / EXAMPLES OF USE



KIT CON AGGANCI AUTOMATICI (KIT WITH AUTOMATIC HOOKS)

KYPI-AMP-A	Base piramidale, supporto medio agganci automatici, autoallineante, con piedini, H totale 435 <i>Pyramidal base, medium support automatic hooks, auto-return, with glides, total H 435</i>
KYPI-ABP-A	Base piramidale, supporto basso agganci automatici, autoallineante, con piedini, H totale 415 <i>Pyramidal base, low support automatic hooks, auto-return, with glides, total H 415</i>
KYPI-GMP-A	Base piramidale, supporto medio agganci automatici, girevole 360°, con piedini, H totale 435 <i>Pyramidal base, medium support automatic hooks, swivel 360°, with glides, total H 435</i>
KYPI-GBP-A	Base piramidale, supporto basso agganci automatici, girevole 360°, con piedini, H totale 415 <i>Pyramidal base, low support automatic hooks, swivel 360°, with glides, total H 415</i>
KY4P-AMP-A	Base 4 razze mini, supporto medio agganci automatici, autoallineante, colonna H 275, con piedini, H totale 420 <i>4 stars mini base, medium support automatic hooks, auto-return, column H 275, with glides, total H 420</i>
KY4P-GMP-A	Base 4 razze mini, supporto medio agganci automatici, girevole 360°, colonna H 280, con piedini, H totale 420 <i>4 stars mini base, medium support automatic hooks, swivel 360°, column H 280, with glides, total H 420</i>
KY4G-AMP-A	Base 4 razze maxi, supporto medio agganci automatici, autoallineante, colonna H 275, con piedini, H totale 420 <i>4 stars maxi base, medium support automatic hooks, auto-return, column H 275, with glides, total H 420</i>
KY4G-GMP-A	Base 4 razze maxi, supporto medio agganci automatici, girevole 360°, colonna H 280, con piedini, H totale 420 <i>4 stars maxi base, medium support automatic hooks, swivel 360°, column H 280, with glides, total H 420</i>
KY5P-GMR-A	Base 5 razze mini, supporto medio agganci automatici, girevole 360°, colonna H 235, con ruote, H totale 425 <i>5 stars mini base, medium support automatic hooks, swivel 360°, column H 265, with castors, total H 425</i>
KY5P-GBR-A	Base 5 razze mini, supporto basso agganci automatici, girevole 360°, colonna H 265, con ruote, H totale 435 <i>5 stars mini base, low support automatic hooks, swivel 360°, column H 280, with castors, total H 435</i>
KY5P-GGR-A	Base 5 razze mini, supporto con leva per alzata a gas agganci automatici, con ruote, H totale min440/max520 <i>5 stars mini base, support with gas lift lever automatic hooks, with castors, total H min440/max520</i>
KY5G-GMR-A	Base 5 razze maxi, supporto medio agganci automatici, girevole 360°, colonna H 235, con ruote, H totale 425 <i>5 stars maxi base, medium support automatic hooks, swivel 360°, column H 235, with castors, total H 425</i>
KY5G-GBR-A	Base 5 razze maxi, supporto basso agganci automatici, girevole 360°, colonna H 265, con ruote, H totale 435 <i>5 stars maxi base, low support automatic hooks, swivel 360°, column H 265, with castors, total H 435</i>
KY5G-GGR-A	Base 5 razze maxi, supporto con leva per alzata a gas agganci automatici, con ruote, H totale min440/max520 <i>5 stars maxi base, support with gas lift lever automatic hooks, with castors, total H min440/max520</i>

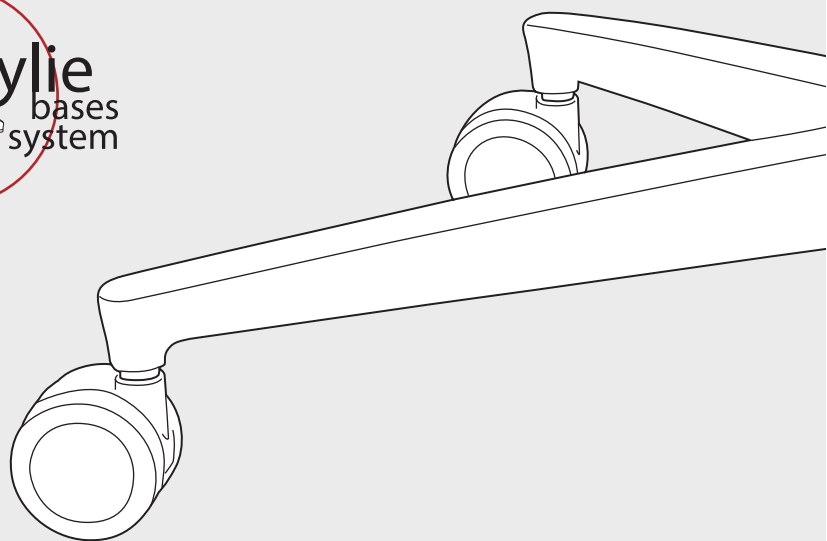
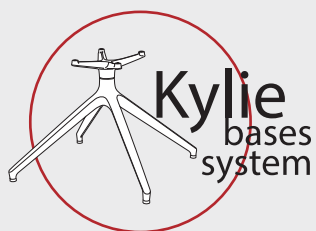
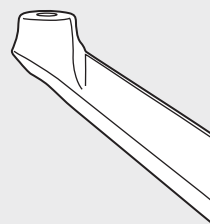
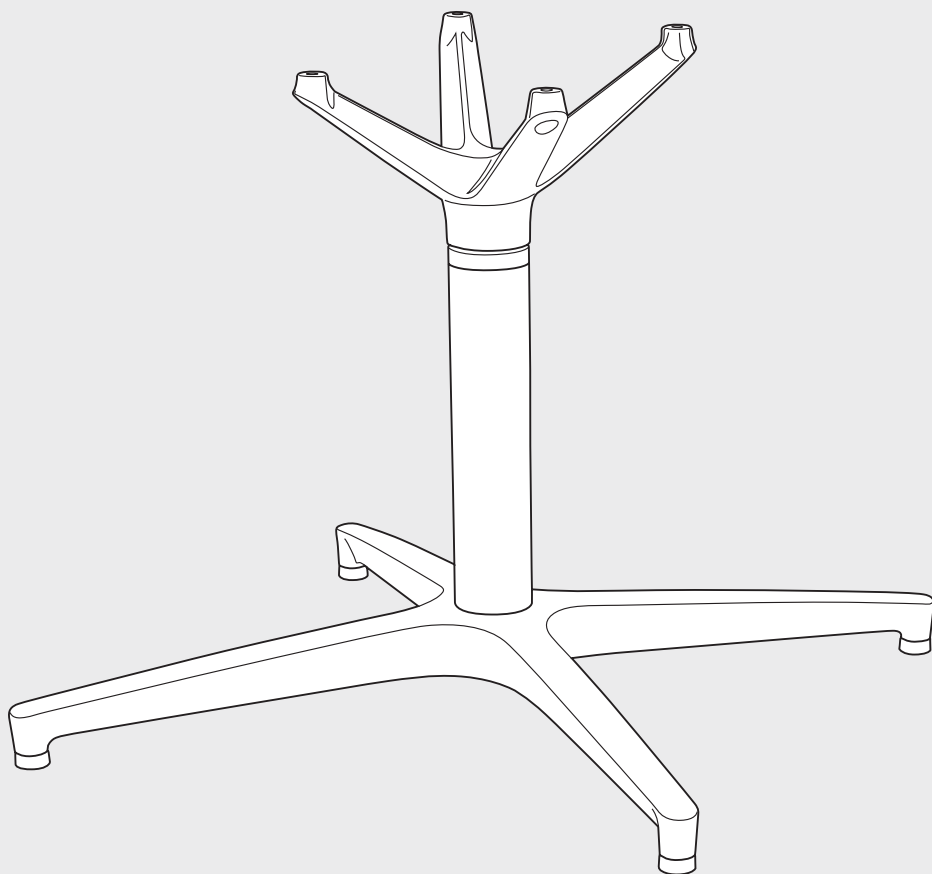

www.BRADO.IT