



ALBA  

2015 CATALOGUE

sieditaliano 

ALBA  

2015 CATALOGUE

sieditaliano 



ALBA  

total quality is our goal



ALBA means italian production at its best,
and sells its components to more than 1.000 clients
in 80 countries all over the world.

ENVIRONMENTAL AWARENESS

In the photo, the photovoltaic system (100KW power) which alone provides
50% of Alba's total energy requirements.



INDICE DI CATEGORIA CATEGORY INDEX



SLIDE

90	164
ABA	68
AVIATOR	198
NEW AVIOR	248
BELLA	192
BUTTERFLY	184
NEW DUETTO	100
EQUITY	152
NEW FEEL	4
FLASH	230
NEW LOGAN	110
MAGIX	220
MICHIGAN	176
MOON	214
OKI	46
PINKO	138
PULL	32
Q5	24
Q9	234
NEW RACE	14
SMILE	40
SQUARE	126
VICENZA	54
NEW X3	86
NEW YEAH	254



4 LEGS

90	164
ABA	68
ATHOS	64
AVIATOR	198
NEW AVIOR	248
BELLA	192
BUTTERFLY	184
CONFORT	210
NEW DUETTO	100
EDEN	258
EQUITY	152
NEW FEEL	4
FLASH	230
NEW LOGAN	110
MAGIX	220
MICHIGAN	176
MOON	214
OKI	46
PACO	60
PINKO	138
PULL	32
Q5	24
Q9	234
NEW RACE	14
SCHOOL	262
SMILE	40
SQUARE	126
VICENZA	54
VICTOR	204
NEW X3	86



SWIVEL

90	164
ABA	68
BUTTERFLY	184
NEW DUETTO	100
EQUITY	152
NEW FEEL	4
NEW LOGAN	110
MAGIX	220
MICHIGAN	176
MOON	214
OKI	46
PINKO	138
PULL	32
Q5	24
NEW RACE	14
SMILE	40
SQUARE	126
VICENZA	54
VICTOR	204
NEW X3	86



BENCH













































90	164
ABA	68
ALA	282
ARIA	270
BELLA	192
BUTTERFLY	184
NEW DUETTO	100
EQUITY	152
NEW FEEL	4
NEW LOGAN	110
LOOK	276
MAGIX	220
MICHIGAN	176
OKI	46
PINKO	138
PULL	32
Q5	24
Q9	234
NEW RACE	14
SITON	286
SMART	266
SMILE	40
SQUARE	126
VICENZA	54
VICTOR	204
NEW X3	86



COMPONENTS

BASES	318
BENCH COMPONENTS	337
COAT HANGERS	306
NEW COMPONENTS	322
NEW FOOT RINGS/COLUMNS	314
OFFICE	300
SLIDE BASES	242
NEW SPOT	290
TABLES	294

INDICE ALFABETICO
ALPHABETICAL INDEX

	90		164		ABA		68		ALA		282		ARIA		270		ATHOS		64		AVIATOR		198		AVIOR		248		BASES		318		BELLA		192
	BENCH COMPONENTS		337		BUTTERFLY		184		COAT HANGERS		306		COMPONENTS		322		CONFORT		210		DUETTO		100		EDEN		258		EQUITY		152		FEEL		4
	FLASH		230		FOOT RINGS COLUMNS		314		LOGAN		110		LOOK		276		MAGIX		220		MICHIGAN		176		MOON		214		OFFICE		300		OKI		46
	PACO		60		PINKO		138		PULL		32		Q5		24		Q9		234		RACE		14		SPOT		290		SCHOOL		262		SLIDE BASES		242
	SITON		286		SMART		266		SMILE		40		SQUARE		126		TABLES		234		VICENZA		54		VICTOR		204		X3		86		YEAH		254



I *feel* inspired



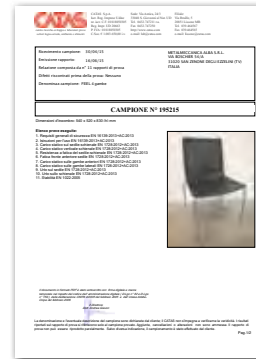

EN 16139



feel

FOLLOW US ON



ALBA  

NEW



FEEL

SLIDE



4 LEGS



SWIVEL



BENCH



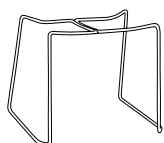
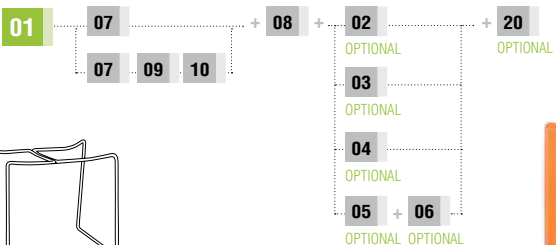
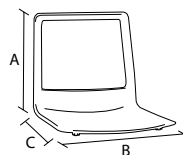
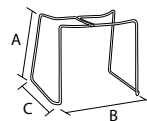
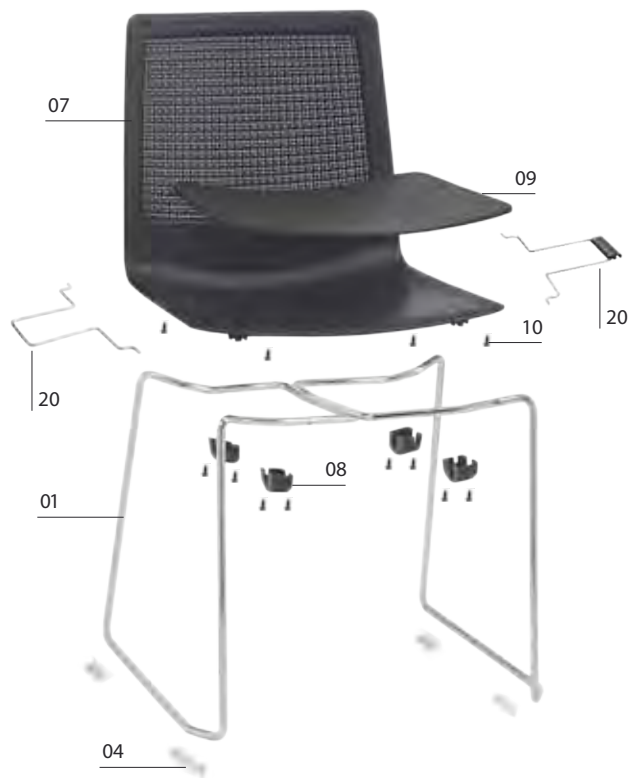

01 FEEL-TELAIO A SLITTA IN TONDINO D.12 FEEL-SLIDE WIRE FRAME D.12									
CODICE/CODE	FINITURA/FINISHING		Q. KIT	Q. MIN/PACK	A	B	C	KG.x1/WT.x1	VOL.x1/UNIT VOL.
113410-057	■ CROMATO/CHROME		x1	100	460	530	470	3,75	mc. 0,03
02 BASE PIANA A PINZA IN PE PER TONDO CLIPS BASE FOR TUBE									
CODICE/CODE	FINITURA/FINISHING		Q. KIT						
134006-020	□ NEUTRO/NEUTRAL		x4						
03 BASE PIANA A PINZA DOPPIA IN PE PER TONDO PER UNIONE SEDIE DOUBLE FLAT CLIP BASE FOR TUBE									
CODICE/CODE	FINITURA/FINISHING		Q. KIT						
134006-021	□ NEUTRO/NEUTRAL		x4						
04 BTf-KIT PIEDINI BTf-KIT FEET									
CODICE/CODE	FINITURA/FINISHING		Q. KIT	Q. MIN/PACK	KG.x1/WT.x1				
134306-001	□ NEUTRO/NEUTRAL		x1	100	0,05				
05 BTfA-KIT PIEDINI CON GANCI BTfA-KIT FEET WITH HOOKS									
CODICE/CODE	FINITURA/FINISHING		Q. KIT	Q. MIN/PACK	KG.x1/WT.x1				
134306-002	□ NEUTRO/NEUTRAL		x1	100	0,06				
06 PPTf-TAPPO PER FISSAGGIO PAVIMENTO PPTf-CAP FOR FIXING TO THE FLOOR									
CODICE/CODE	FINITURA/FINISHING		Q. KIT	Q. MIN/PACK	KG.x1/WT.x1				
134306-003	□ NEUTRO/NEUTRAL		x2	100	0,03				
07 FEEL-SCocca INTERA MODELLO FEEL FEEL-PLASTIC SHELL MODEL FEEL									
CODICE/CODE	FINITURA/FINISHING		Q. KIT	Q. MIN/PACK	A	B	C	KG.x1/WT.x1	VOL.x1/UNIT VOL.
133915-060	■ BLU/BLUE	RAL5014	x1	10	420	450	430	1,70	mc. 0,02
133907-060	■ ARANCIO/ORANGE	RAL2003	x1	10	420	450	430	1,70	mc. 0,02
133903-060	■ NERO/BLACK	RAL9005	x1	10	420	450	430	1,70	mc. 0,02
133916-060	■ VERDE/GREEN	PANTONE 7495EL	x1	10	420	450	430	1,70	mc. 0,02
133905-060	□ BIANCO/WHITE	218	x1	10	420	450	430	1,70	mc. 0,02
133904-060	■ GRIGIO/GREY	RAL7003	x1	10	420	450	430	1,70	mc. 0,02
133907-059	■ SABBIA/SAND	RAL1019	x1	10	420	450	430	1,70	mc. 0,02
133902-060	■ ROSSO/RED	RAL527	x1	10	420	450	430	1,70	mc. 0,02
133903-059	■ NERO/BLACK RAL9005	autoestinguente/fire retardant	x1	10	420	450	430	1,70	mc. 0,02
08 FEEL-CONFEZIONE ACCESSORI PER SCocca FEEL PER TONDINO FEEL-ACCESSORY PACK FOR WIRE FRAME FEEL									
CODICE/CODE	FINITURA/FINISHING		Q. KIT	Q. MIN/PACK	telaino in tondino/wire frame		KG.x1/WT.x1 VOL.x1/UNIT VOL.		
137015-061	■ BLU/BLUE	RAL5014	x1	10	telaino in tondino/wire frame		0,07 mc. 0,001		
137007-061	■ ARANCIO/ORANGE	RAL2003	x1	10	telaino in tondino/wire frame		0,07 mc. 0,001		
137003-061	■ NERO/BLACK	RAL9005	x1	10	telaino in tondino/wire frame		0,07 mc. 0,001		
137016-061	■ VERDE/GREEN	PANTONE 7495EL	x1	10	telaino in tondino/wire frame		0,07 mc. 0,001		
137005-061	□ BIANCO/WHITE	218	x1	10	telaino in tondino/wire frame		0,07 mc. 0,001		
137004-061	■ GRIGIO/GREY	RAL7003	x1	10	telaino in tondino/wire frame		0,07 mc. 0,001		
137007-058	■ SABBIA/SAND	RAL1019	x1	10	telaino in tondino/wire frame		0,07 mc. 0,001		
137002-061	■ ROSSO/RED	RAL527	x1	10	telaino in tondino/wire frame		0,07 mc. 0,001		
137003-063	■ NERO/BLACK RAL9005	autoestinguente/fire retardant	x1	10	telaino in tondino/wire frame		0,07 mc. 0,001		
09 FEEL-PANNELLO SEDILE DA TAPPEZZARE FEEL-PANEL BACK FOR UPHOLSTERY									
CODICE/CODE	FINITURA/FINISHING		Q. KIT	Q. MIN/PACK	A	B	KG.x1/WT.x1 VOL.x1/UNIT VOL.		
132203-059	■ NERO/BLACK		x1	20	400	440	0,6 mc. 0,003		
10 VITE HILO TB+ 5x14 ZINCATA NERA (per fissare pannello sedile) SCREW HILO TB+ 5x14 FOR UPHOLSTERY SEAT PANEL									
CODICE/CODE	FINITURA/FINISHING		Q. KIT						
117803-155	■ NERO/BLACK		x8						
20 FEEL-COPPIA AGGANCI LATERALE IN TONDINO + PLASTICA FEEL-PAIR SIDE WIRE HOOKS + PLASTIC									
CODICE/CODE	FINITURA/FINISHING		Q. KIT	KG.x1/WT.x1 VOL.x1/UNIT VOL.					
113410-056	■ CROMATO/CHROME		x1	0,15 mc. 0,002					

OPTIONAL 20
COPPIA AGGANCI LATERALE
COUPLE LATERAL HOOK



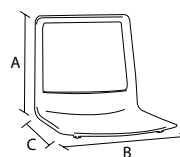
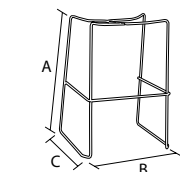
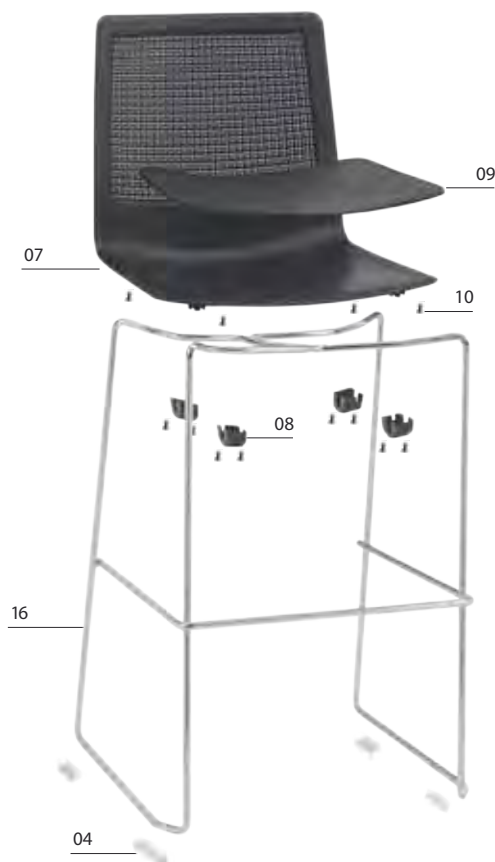

16 FEEL-SGABELLO ALTO H730 IN TONDINO D.12 PER SCOCCA SENZA TAPPI
FEEL-WIRE D.12 HIGH BAR STOOL H730 FOR SHELL FEEL WITHOUT CAPS

CODICE/CODE	FINITURA/FINISHING	Q.KIT	Q.MIN/PACK	A	B	C	KG.x1/WT.x1	VOL.x1/UNIT VOL.
113410-059	■ CROMATO/CHROME	x1	50	730	530	500	6,20	mc. 0,08

07 FEEL-SCOCCA INTERA MODELLO FEEL
FEEL-PLASTIC SHELL MODEL FEEL

CODICE/CODE	FINITURA/FINISHING	Q.KIT	Q.MIN/PACK	A	B	C	KG.x1/WT.x1	VOL.x1/UNIT VOL.
133915-060	■ BLU/BLUE RAL5014	x1	10	420	430	450	1,70	mc. 0,02
133907-060	■ ARANCIO/ORANGE RAL2003	x1	10	420	430	450	1,70	mc. 0,02
133903-060	■ NERO/BLACK RAL9005	x1	10	420	430	450	1,70	mc. 0,02
133916-060	■ VERDE/GREEN PANTONE 7495EL	x1	10	420	430	450	1,70	mc. 0,02
133905-060	□ BIANCO/WHITE 218	x1	10	420	430	450	1,70	mc. 0,02
133904-060	■ GRIGIO/GREY RAL7003	x1	10	420	430	450	1,70	mc. 0,02
133907-059	■ SABBIA/SAND RAL1019	x1	10	420	430	450	1,70	mc. 0,02
133902-060	■ ROSSO/RED RAL527	x1	10	420	430	450	1,70	mc. 0,02
133903-059	■ NERO/BLACK RAL9005 autoestinguente/fire retardant	x1	10	420	430	450	1,70	mc. 0,02

08 FEEL-CONFEZIONE ACCESSORI PER SCOCCA FEEL PER TONDINO
FEEL-ACCESSORY PACK FOR WIRE FRAME FEEL

CODICE/CODE	FINITURA/FINISHING	Q.KIT	Q.MIN/PACK	KG.x1/WT.x1	VOL.x1/UNIT VOL.
137015-061	■ BLU/BLUE RAL5014	x1	10	telaio in tondino/wire frame	0,07 mc. 0,001
137007-061	■ ARANCIO/ORANGE RAL2003	x1	10	telaio in tondino/wire frame	0,07 mc. 0,001
137003-061	■ NERO/BLACK RAL9005	x1	10	telaio in tondino/wire frame	0,07 mc. 0,001
137016-061	■ VERDE/GREEN PANTONE 7495EL	x1	10	telaio in tondino/wire frame	0,07 mc. 0,001
137005-061	□ BIANCO/WHITE 218	x1	10	telaio in tondino/wire frame	0,07 mc. 0,001
137004-061	■ GRIGIO/GREY RAL7003	x1	10	telaio in tondino/wire frame	0,07 mc. 0,001
137007-058	■ SABBIA/SAND RAL1019	x1	10	telaio in tondino/wire frame	0,07 mc. 0,001
137002-061	■ ROSSO/RED RAL527	x1	10	telaio in tondino/wire frame	0,07 mc. 0,001
137003-063	■ NERO/BLACK RAL9005 autoestinguente/fire retardant	x1	10	telaio in tondino/wire frame	0,07 mc. 0,001

09 FEEL-PANNELLO SEDILE DA TAPPEZZARE
FEEL-PANEL BACK FOR UPHOLSTERY

CODICE/CODE	FINITURA/FINISHING	Q.KIT	Q.MIN/PACK	A	B	KG.x1/WT.x1	VOL.x1/UNIT VOL.
132203-059	■ NERO/BLACK	x1	20	400	440	0,6	mc. 0,003

10 VITE HILO TB+ 5x14 ZINCATA NERA (per fissare pannello sedile)
SCREW HILO TB+ 5X14 FOR UPHOLSTERY SEAT PANEL

CODICE/CODE	FINITURA/FINISHING	Q.KIT
117803-155	■ NERO/BLACK	x8

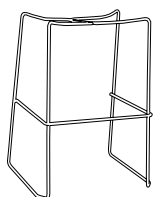
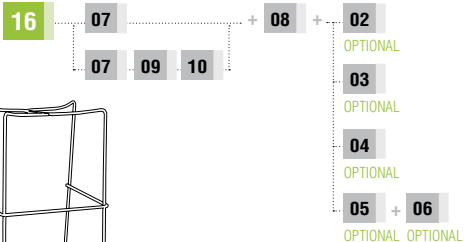

OPTIONAL 02
BASE PIANA A PINZA
CLIPS BASE



OPTIONAL 03
BASE PIANA A PINZA DOPIA
DOUBLE FLAT CLIP BASE



OPTIONAL 04
BTF-KIT PIEDINI
BTF-KIT FEET



OPTIONAL 05
BTFA-KIT PIEDINI CON GANCI
BTFA-KIT FEET WITH HOOKS



OPTIONAL 06
PPTF-TAPPO PER FISSAGGIO PAVIMENTO
PPTF-CAP FOR FIXING TO THE FLOOR



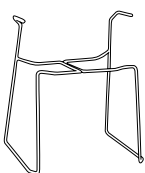
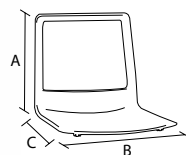
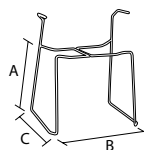

- 02 OPTIONAL
- 03 OPTIONAL
- 04 OPTIONAL
- 05 + 06 OPTIONAL OPTIONAL



11 FEEL-TELAIO A SLITTA IN TONDINO D.12 CON BRACCIOLI

CODICE/CODE	FINITURA/FINISHING	Q.KIT	Q.MIN/PACK	A	B	C	KG.x1/WT.x1	VOL.x1/UNIT VOL.
113410-058	■ CROMATO/CHROME	x1	60	460	530	470	4,50	mc. 0,035

02 BASE PIANA A PINZA IN PE PER TONDO

CODICE/CODE	FINITURA/FINISHING	Q.KIT
134006-020	□ NEUTRO/NEUTRAL	x4

03 BASE PIANA A PINZA DOPIA IN PE PER TONDO PER UNIONE SEDILE

CODICE/CODE	FINITURA/FINISHING	Q.KIT
134006-021	□ NEUTRO/NEUTRAL	x4

04 BTF-KIT PIEDINI

CODICE/CODE	FINITURA/FINISHING	Q.KIT	Q.MIN/PACK	KG.x1/WT.x1
134306-001	□ NEUTRO/NEUTRAL	x1	100	0,05

05 BTFA-KIT PIEDINI CON GANCI

CODICE/CODE	FINITURA/FINISHING	Q.KIT	Q.MIN/PACK	KG.x1/WT.x1
134306-002	□ NEUTRO/NEUTRAL	x1	100	0,06

06 PPTF-TAPPO PER FISSAGGIO PAVIMENTO

CODICE/CODE	FINITURA/FINISHING	Q.KIT	Q.MIN/PACK	KG.x1/WT.x1
134306-003	□ NEUTRO/NEUTRAL	x2	100	0,03

07 FEEL-SCOCCA INTERA MODELLO FEEL

CODICE/CODE	FINITURA/FINISHING	Q.KIT	Q.MIN/PACK	A	B	C	KG.x1/WT.x1	VOL.x1/UNIT VOL.	
133915-060	■ BLU/BLUE	RAL5014	x1	10	420	450	430	1,70	mc. 0,02
133907-060	■ ARANCIO/ORANGE	RAL2003	x1	10	420	450	430	1,70	mc. 0,02
133903-060	■ NERO/BLACK	RAL9005	x1	10	420	450	430	1,70	mc. 0,02
133916-060	■ VERDE/GREEN	PANTONE 7495EL	x1	10	420	450	430	1,70	mc. 0,02
133905-060	□ BIANCO/WHITE	218	x1	10	420	450	430	1,70	mc. 0,02
133904-060	■ GRIGIO/GREY	RAL7003	x1	10	420	450	430	1,70	mc. 0,02
133907-059	■ SABBIA/SAND	RAL1019	x1	10	420	450	430	1,70	mc. 0,02
133902-060	■ ROSSO/RED	RAL527	x1	10	420	450	430	1,70	mc. 0,02
133903-059	■ NERO/BLACK RAL9005	autoestinguente/fire retardant	x1	10	420	450	430	1,70	mc. 0,02

08 FEEL-CONFEZIONE ACCESSORI PER SCOCCA FEEL PER TONDINO

CODICE/CODE	FINITURA/FINISHING	Q.KIT	Q.MIN/PACK	KG.x1/WT.x1	VOL.x1/UNIT VOL.
137015-061	■ BLU/BLUE	RAL5014	x1	10	telaio in tondino/wire frame 0,07 mc. 0,001
137007-061	■ ARANCIO/ORANGE	RAL2003	x1	10	telaio in tondino/wire frame 0,07 mc. 0,001
137003-061	■ NERO/BLACK	RAL9005	x1	10	telaio in tondino/wire frame 0,07 mc. 0,001
137016-061	■ VERDE/GREEN	PANTONE 7495EL	x1	10	telaio in tondino/wire frame 0,07 mc. 0,001
137005-061	□ BIANCO/WHITE	218	x1	10	telaio in tondino/wire frame 0,07 mc. 0,001
137004-061	■ GRIGIO/GREY	RAL7003	x1	10	telaio in tondino/wire frame 0,07 mc. 0,001
137007-058	■ SABBIA/SAND	RAL1019	x1	10	telaio in tondino/wire frame 0,07 mc. 0,001
137002-061	■ ROSSO/RED	RAL527	x1	10	telaio in tondino/wire frame 0,07 mc. 0,001
137003-063	■ NERO/BLACK RAL9005	autoestinguente/fire retardant	x1	10	telaio in tondino/wire frame 0,07 mc. 0,001

09 FEEL-PANNELLO SEDILE DA TAPPEZZARE

CODICE/CODE	FINITURA/FINISHING	Q.KIT	Q.MIN/PACK	A	B	KG.x1/WT.x1	VOL.x1/UNIT VOL.
132203-059	■ NERO/BLACK	x1	20	400	440	0,6	mc. 0,003

10 VITE HILO TB+ 5x14 ZINCATA NERA (per fissare pannello sedile)

CODICE/CODE	FINITURA/FINISHING	Q.KIT
117803-155	■ NERO/BLACK	x8

OPTIONAL 02
BASE PIANA A PINZA
CLIPS BASE

OPTIONAL 03
BASE PIANA A PINZA DOPIA
DOUBLE FLAT CLIP BASE

OPTIONAL 04
BTF-KIT PIEDINI
BTF-KIT FEET

OPTIONAL 05
BTFA-KIT PIEDINI CON GANCI
BTFA-KIT FEET WITH HOOKS

OPTIONAL 06
PPTF-TAPPO PER FISSAGGIO PAVIMENTO
PPTF-CAP FOR FIXING TO THE FLOOR



12 FEEL-COPPIA BRACCIOLI IN PLASTICA COLORATA PER SLITTA CON E SENZA TAVOLETTA
FEEL-PAIR COLORED PLASTIC ARM FOR WIRE FRAME WITH/WITHOUT TABLET

CODICE/CODE	FINITURA/FINISHING	Q. KIT	Q. MIN/PACK	A	B	KG. x1/WT.x1	VOL. x1/UNIT VOL.
131715-057	■ BLU/BLUE	RAL5014	x1	40	right + left	200 30	0,16 mc. 0,0045
131715-058	■ BLU/BLUE	RAL5014	x1	40	right + left for tablet	200 30	0,16 mc. 0,0045
131715-059	■ BLU/BLUE	RAL5014	x1	40	left + right for tablet	200 30	0,16 mc. 0,0045
131707-056	■ ARANCIO/ORANGE	RAL2003	x1	40	right + left	200 30	0,16 mc. 0,0045
131707-057	■ ARANCIO/ORANGE	RAL2003	x1	40	right + left for tablet	200 30	0,16 mc. 0,0045
131707-058	■ ARANCIO/ORANGE	RAL2003	x1	40	left + right for tablet	200 30	0,16 mc. 0,0045
131703-057	■ NERO/BLACK	RAL9005	x1	40	right + left	200 30	0,16 mc. 0,0045
131703-058	■ NERO/BLACK	RAL9005	x1	40	right + left for tablet	200 30	0,16 mc. 0,0045
131703-059	■ NERO/BLACK	RAL9005	x1	40	left + right for tablet	200 30	0,16 mc. 0,0045
131716-057	■ VERDE/GREEN	PANTONE 7495EL	x1	40	right + left	200 30	0,16 mc. 0,0045
131716-058	■ VERDE/GREEN	PANTONE 7495EL	x1	40	right + left for tablet	200 30	0,16 mc. 0,0045
131716-059	■ VERDE/GREEN	PANTONE 7495EL	x1	40	left + right for tablet	200 30	0,16 mc. 0,0045
131705-057	□ BIANCO/WHITE	218	x1	40	right + left	200 30	0,16 mc. 0,0045
131705-058	□ BIANCO/WHITE	218	x1	40	right + left for tablet	200 30	0,16 mc. 0,0045
131705-059	□ BIANCO/WHITE	218	x1	40	left + right for tablet	200 30	0,16 mc. 0,0045
131704-057	■ GRIGIO/GREY	RAL7003	x1	40	right + left	200 30	0,16 mc. 0,0045
131704-058	■ GRIGIO/GREY	RAL7003	x1	40	right + left for tablet	200 30	0,16 mc. 0,0045
131704-059	■ GRIGIO/GREY	RAL7003	x1	40	left + right for tablet	200 30	0,16 mc. 0,0045
131707-053	■ SABBIA/SAND	RAL1019	x1	40	right + left	200 30	0,16 mc. 0,0045
131707-054	■ SABBIA/SAND	RAL1019	x1	40	right + left for tablet	200 30	0,16 mc. 0,0045
131707-055	■ SABBIA/SAND	RAL1019	x1	40	left + right for tablet	200 30	0,16 mc. 0,0045
131702-057	■ ROSSO/RED	RAL527	x1	40	right + left	200 30	0,16 mc. 0,0045
131702-058	■ ROSSO/RED	RAL527	x1	40	right + left for tablet	200 30	0,16 mc. 0,0045
131702-059	■ ROSSO/RED	RAL527	x1	40	left + right for tablet	200 30	0,16 mc. 0,0045
131703-157	■ NERO/BLACK RAL9005	autoestinguente/fire retardant	x1	40	right + left	200 30	0,16 mc. 0,0045
131703-158	■ NERO/BLACK RAL9005	autoestinguente/fire retardant	x1	40	right + left for tablet	200 30	0,16 mc. 0,0045
131703-159	■ NERO/BLACK RAL9005	autoestinguente/fire retardant	x1	40	left + right for tablet	200 30	0,16 mc. 0,0045

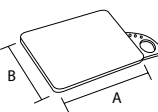
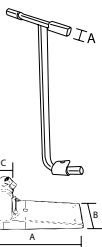
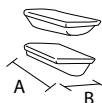

13 FEEL-SUPPORTO TAVOLETTA PER SLITTA + VITI
FEEL-TABLET SUPPORT FOR SLIDE WIRE FRAME D.11 + SCREWS

CODICE/CODE	FINITURA/FINISHING	Q. KIT	Q. MIN/PACK	A	KG. x1/WT.x1	VOL. x1/UNIT VOL.
111710-078	■ CROMATO/CHROME destro/right	x1	10	15x15	0,6	mc. 0,002
111710-079	■ CROMATO/CHROME sinistro/left	x1	10	15x15	0,6	mc. 0,002

14 SPT2-SNODO PER TAVOLETTA IN TERMOPLASTICA
SPT2-THERMOPLASTIC WRITING TABLET ARTICULATION

CODICE/CODE	FINITURA/FINISHING	Q. KIT	Q. MIN/PACK	A	B	C	KG. x1/WT.x1	VOL. x1/UNIT VOL.
134003-039	■ NERO/BLACK	x1	20	180	66	15x15	0,35	mc. 0,0006

15 TLT3-TAVOLETTA AMBIDESTRO CON PORTABICCHIERE E PORTAPENNE
TLT3-WRITING TABLET WITH CUP HOLDER AND PEN TRAY

CODICE/CODE	FINITURA/FINISHING	Q. KIT	Q. MIN/PACK	A	B	KG. x1/WT.x1	VOL. x1/UNIT VOL.
134003-041	■ NERO/BLACK	x1	10	410	300		1,05 mc. 0,036

27 VITE HILO TB+ 5x14 ZINCATA NERA (per fissare bracciolo)
SCREW HILO TB+ 5X14 FOR ARM

CODICE/CODE	FINITURA/FINISHING	Q. KIT
117803-155	■ NERO/BLACK	x4

FEEL-CARRELLO PORTASEDIE CON ACCESSORI NERO
FEEL-TROLLEY FOR CHAIRS WITH ACCESSORIES BLACK

CODICE/CODE	FINITURA/FINISHING	Q. KIT
110803-053	■ NERO/BLACK	x1

OPTIONAL

TAVOLETTA TLT
TLT TABLET



VEDI/SEE PAG. 327

TAVOLETTA TLT2
TLT2 TABLET



VEDI/SEE PAG. 327

TAVOLETTA TLT3
TLT3 TABLET



VEDI/SEE PAG. 327

TAVOLETTA BEAN
BEAN TABLET



VEDI/SEE PAG. 327

TAVOLETTA TL01
TL01 TABLET



VEDI/SEE PAG. 327

SNODO TAVOLETTA SPT2
SPT2 MECHANISM TABLET



VEDI/SEE PAG. 326

SNODO ANTIPANICO
MECHANISM ANTIPANIC



VEDI/SEE PAG. 326



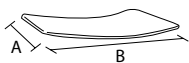
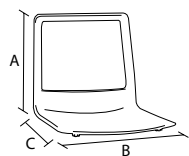
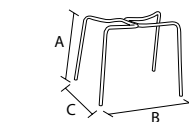
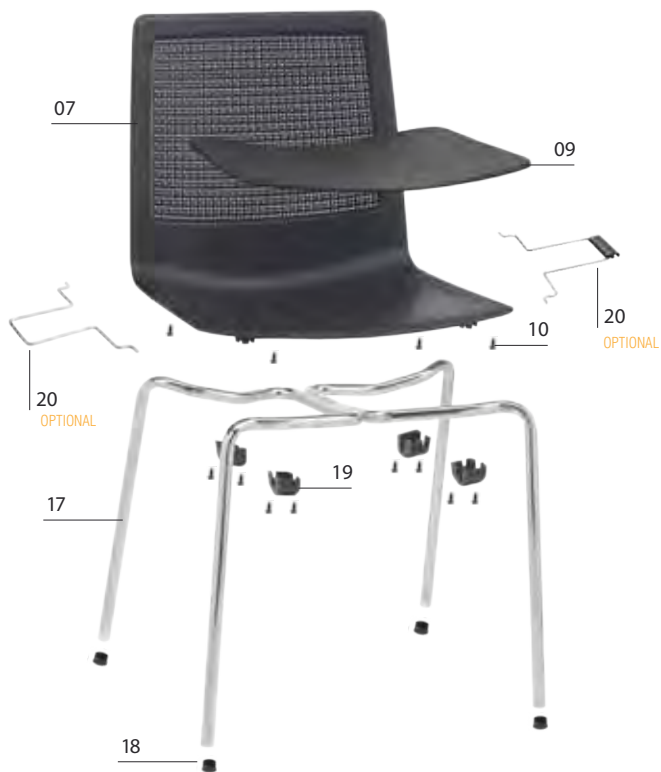

17 FEEL-TELAIO 4 GAMBE IN TUBO D.18 SENZA TAPPI

FEEL-4 LEGS FRAMES D.18 WITHOUT CAPS			Q.KIT	Q.MIN/PACK	A	B	C	KG.x1/WT.x1	VOL.x1/UNIT VOL.
112703-031	■ NERO/BLACK	RAL9005	x1	200	440	510	500	2	mc. 0,025
112704-031	■ GRIGIO/GREY	RAL7003	x1	60	440	510	500	2	mc. 0,025
112705-031	□ BIANCO/WHITE	RAL9003	x1	60	440	510	500	2	mc. 0,025
112710-031	■ CROMATO/CHROME		x1	200	440	510	500	2	mc. 0,025
112703-032*	■ NERO/BLACK	RAL9005	*per esterno/outdoor	x1	200	440	510	2	mc. 0,025
112704-032*	■ GRIGIO/GREY	RAL7003	*per esterno/outdoor	x1	200	440	510	2	mc. 0,025
112705-032*	□ BIANCO/WHITE	RAL9003	*per esterno/outdoor	x1	200	440	510	2	mc. 0,025

18 PUNTALE ALETTATO TONDO D.18 NERO

INNER CAP FOR LEGS D.18 BLACK			Q.KIT						
134203-180	■ NERO/BLACK		x4						
134205-181	□ BIANCO/WHITE		x4						

07 FEEL-SCOCCA INTERA MODELLO FEEL

FEEL-PLASTIC SHELL MODEL FEEL			Q.KIT	Q.MIN/PACK	A	B	C	KG.x1/WT.x1	VOL.x1/UNIT VOL.
133915-060	■ BLU/BLUE	RAL5014	x1	10	420	450	430	1,70	mc. 0,02
133907-060	■ ARANCIO/ORANGE	RAL2003	x1	10	420	450	430	1,70	mc. 0,02
133903-060	■ NERO/BLACK	RAL9005	x1	10	420	450	430	1,70	mc. 0,02
133916-060	■ VERDE/GREEN	PANTONE 7495EL	x1	10	420	450	430	1,70	mc. 0,02
133905-060	□ BIANCO/WHITE	218	x1	10	420	450	430	1,70	mc. 0,02
133904-060	■ GRIGIO/GREY	RAL7003	x1	10	420	450	430	1,70	mc. 0,02
133907-059	■ SABBIA/SAND	RAL1019	x1	10	420	450	430	1,70	mc. 0,02
133902-060	■ ROSSO/RED	RAL527	x1	10	420	450	430	1,70	mc. 0,02
133903-059	■ NERO/BLACK RAL9005	autoestinguente/fire retardant	x1	10	420	450	430	1,70	mc. 0,02

19 FEEL-CONFEZIONE ACCESSORI PER SCOCCA FEEL PER TUBO D.18

FEEL-ACCESSORY PACK FOR SHELL FEEL FOR TUBE D.18			Q.KIT	Q.MIN/PACK				KG.x1/WT.x1	VOL.x1/UNIT VOL.
137015-060	■ BLU/BLUE	RAL5014	x1	10	telaio tubo/tube frame			0,07	mc. 0,001
137007-060	■ ARANCIO/ORANGE	RAL2003	x1	10	telaio tubo/tube frame			0,07	mc. 0,001
137003-060	■ NERO/BLACK	RAL9005	x1	10	telaio tubo/tube frame			0,07	mc. 0,001
137016-060	■ VERDE/GREEN	PANTONE 7495EL	x1	10	telaio tubo/tube frame			0,07	mc. 0,001
137005-060	□ BIANCO/WHITE	218	x1	10	telaio tubo/tube frame			0,07	mc. 0,001
137004-060	■ GRIGIO/GREY	RAL7003	x1	10	telaio tubo/tube frame			0,07	mc. 0,001
137007-059	■ SABBIA/SAND	RAL1019	x1	10	telaio tubo/tube frame			0,07	mc. 0,001
137002-060	■ ROSSO/RED	RAL527	x1	10	telaio tubo/tube frame			0,07	mc. 0,001
137003-062	■ NERO/BLACK RAL9005	autoestinguente/fire retardant	x1	10	telaio tubo/tube frame			0,07	mc. 0,001

09 FEEL-PANNELLO SEDILE DA TAPPEZZARE

FEEL-PANEL BACK FOR UPHOLSTERY			Q.KIT	Q.MIN/PACK	A	B	KG.x1/WT.x1	VOL.x1/UNIT VOL.
132203-059	■ NERO/BLACK		x1	20	400	440	0,6	mc. 0,003

10 VITE HILO TB+ 5x14 ZINCATA NERA (per fissare pannello sedile)

SCREW HILO TB+ 5X14 FOR UPHOLSTERY SEAT PANEL			Q.KIT						
117803-155	■ NERO/BLACK		x8						

20 FEEL-COPPIA AGGANCI LATERALE IN TONDINO + PLASTICA

FEEL-PAIR SIDE WIRE HOOKS + PLASTIC			Q.KIT					KG.x1/WT.x1	VOL.x1/UNIT VOL.
113410-056	■ CROMATO/CHROME		x1					0,15	mc. 0,002

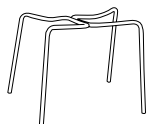

OPTIONAL 20
COPPIA AGGANCI LATERALE
COUPLE LATERAL HOOK



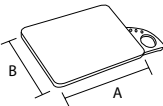
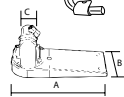
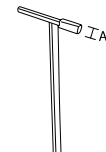
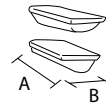
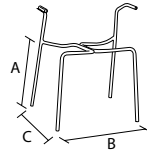

21 FEEL-TELAIO 4 GAMBE D.18 CON BRACCIOLI SENZA TAPPI

FEEL-4 LEGS FRAME D.18 WITH ARM AND WITHOUT CAPS									
CODICE/CODE	FINITURA/FINISHING	Q. KIT	Q. MIN/PACK	A	B	C	KG.x1/WT.x1	VOL.x1/UNIT VOL.	
112703-033	■ NERO/BLACK	x1	60	440	510	500	2,6	mc. 0,035	
112704-033	■ GRIGIO/GREY RAL7003	x1	60	440	510	500	2,6	mc. 0,035	
112705-033	□ BIANCO/WHITE RAL9003	x1	60	440	510	500	2,6	mc. 0,035	
112710-033	■ CROMATO/CHROME	x1	60	440	510	500	2,6	mc. 0,035	
112703-034*	■ NERO/BLACK	x1	60	440	510	500	2,6	mc. 0,035	*outdoor version
112704-034*	■ GRIGIO/GREY RAL7003	x1	60	440	510	500	2,6	mc. 0,035	*outdoor version
112705-034*	□ BIANCO/WHITE RAL9003	x1	60	440	510	500	2,6	mc. 0,035	*outdoor version

22 FEEL-COPPIA BRACCIOLI IN PLASTICA COLORATA PER 4 GAMBE CON E SENZA TAVOLETTA

FEEL-PAIR COLORED PLASTIC ARM FOR 4 LEGS FRAME WITH/WITHOUT TABLET									
CODICE/CODE	FINITURA/FINISHING	Q. KIT	Q. MIN/PACK	A	B	KG.x1/WT.x1	VOL.x1/UNIT VOL.		
131715-062	■ BLU/BLUE RAL5014	x1	-	right + left	200	30	0,16	mc. 0,001	
131715-063	■ BLU/BLUE RAL5014	x1	-	right + left for tablet	200	30	0,16	mc. 0,001	
131715-064	■ BLU/BLUE RAL5014	x1	-	left + right for tablet	200	30	0,16	mc. 0,001	
131707-062	■ ARANCIO/ORANGE RAL2003	x1	-	right + left	200	30	0,16	mc. 0,001	
131707-063	■ ARANCIO/ORANGE RAL2003	x1	-	right + left for tablet	200	30	0,16	mc. 0,001	
131707-064	■ ARANCIO/ORANGE RAL2003	x1	-	left + right for tablet	200	30	0,16	mc. 0,001	
131703-062	■ NERO/BLACK RAL9005	x1	-	right + left	200	30	0,16	mc. 0,001	
131703-063	■ NERO/BLACK RAL9005	x1	-	right + left for tablet	200	30	0,16	mc. 0,001	
131703-064	■ NERO/BLACK RAL9005	x1	-	left + right for tablet	200	30	0,16	mc. 0,001	
131716-062	■ VERDE/GREEN PANTONE 7495SEL	x1	-	right + left	200	30	0,16	mc. 0,001	
131716-063	■ VERDE/GREEN PANTONE 7495SEL	x1	-	right + left for tablet	200	30	0,16	mc. 0,001	
131716-064	■ VERDE/GREEN PANTONE 7495SEL	x1	-	left + right for tablet	200	30	0,16	mc. 0,001	
131705-062	□ BIANCO/WHITE 218	x1	-	right + left	200	30	0,16	mc. 0,001	
131705-063	□ BIANCO/WHITE 218	x1	-	right + left for tablet	200	30	0,16	mc. 0,001	
131705-064	□ BIANCO/WHITE 218	x1	-	left + right for tablet	200	30	0,16	mc. 0,001	
131704-062	■ GRIGIO/GREY RAL7003	x1	-	right + left	200	30	0,16	mc. 0,001	
131704-063	■ GRIGIO/GREY RAL7003	x1	-	right + left for tablet	200	30	0,16	mc. 0,001	
131704-064	■ GRIGIO/GREY RAL7003	x1	-	left + right for tablet	200	30	0,16	mc. 0,001	
131707-059	■ SABBIA/SAND RAL1019	x1	-	right + left	200	30	0,16	mc. 0,001	
131707-060	■ SABBIA/SAND RAL1019	x1	-	right + left for tablet	200	30	0,16	mc. 0,001	
131707-061	■ SABBIA/SAND RAL1019	x1	-	left + right for tablet	200	30	0,16	mc. 0,001	
131702-062	■ ROSSO/RED RAL527	x1	-	right + left	200	30	0,16	mc. 0,001	
131702-063	■ ROSSO/RED RAL527	x1	-	right + left for tablet	200	30	0,16	mc. 0,001	
131702-064	■ ROSSO/RED RAL527	x1	-	left + right for tablet	200	30	0,16	mc. 0,001	
131703-162	■ NERO/BLACK RAL9005 autoestinguente/fire retardant	x1	-	right + left	200	30	0,16	mc. 0,001	
131703-163	■ NERO/BLACK RAL9005 autoestinguente/fire retardant	x1	-	right + left for tablet	200	30	0,16	mc. 0,001	
131703-164	■ NERO/BLACK RAL9005 autoestinguente/fire retardant	x1	-	left + right for tablet	200	30	0,16	mc. 0,001	

23 FEEL-SUPPORTO TAVOLETTA PER 4 GAMBE + VITI

FEEL-TABLET SUPPORT FOR 4 LEGS + SCREWS									
CODICE/CODE	FINITURA/FINISHING	Q. KIT	Q. MIN/PACK	A	B	KG.x1/WT.x1	VOL.x1/UNIT VOL.		
111703-070	■ NERO/BLACK RAL9005 destro/right	x1	10	15x15		0,6	mc. 0,002		
111703-071	■ NERO/BLACK RAL9005 sinistro/left	x1	10	15x15		0,6	mc. 0,002		
111710-076	■ CROMATO/CHROME destro/right	x1	10	15x15		0,6	mc. 0,002		
111710-077	■ CROMATO/CHROME sinistro/left	x1	10	15x15		0,6	mc. 0,002		

14 SPT2-SNODO PER TAVOLETTA IN TERMOPLASTICA

SPT2-THERMOPLASTIC WRITING TABLET ARTICULATION									
CODICE/CODE	FINITURA/FINISHING	Q. KIT	Q. MIN/PACK	A	B	C	KG.x1/WT.x1	VOL.x1/UNIT VOL.	
134003-039	■ NERO/BLACK	x1	20	180	66	15x15	0,35	mc. 0,0006	

15 TLT3-TAVOLETTA AMBIDESTRO CON PORTABICCHIERE E PORTAPENNA

TLT3-WRITING TABLET WITH CUP HOLDER AND PEN TRAY									
CODICE/CODE	FINITURA/FINISHING	Q. KIT	Q. MIN/PACK	A	B	KG.x1/WT.x1	VOL.x1/UNIT VOL.		
134003-041	■ NERO/BLACK	x1	10	410	300		1,05	mc. 0,036	

27 VITE HILO TB+ 5x14 ZINCATO NERA (per fissare braccioli)

SCREW HILO TB+ 5X14 FOR ARM									
CODICE/CODE	FINITURA/FINISHING	Q. KIT	Q. MIN/PACK	A	B	KG.x1/WT.x1	VOL.x1/UNIT VOL.		
117803-155	■ NERO/BLACK	x4							

OPTIONAL

TAVOLETTA TLT TLT TABLET	TAVOLETTA TLT2 TLT2 TABLET	TAVOLETTA TLT3 TLT3 TABLET	TAVOLETTA BEAN BEAN TABLET	TAVOLETTA TL01 TL01 TABLET	SNODO TAVOLETTA SPT2 SPT2 MECHANISM TABLET	SNODO ANTIPANICO MECHANISM ANTIPANICO
VEDI/SEE PAG. 327	VEDI/SEE PAG. 327	VEDI/SEE PAG. 327	VEDI/SEE PAG. 327	VEDI/SEE PAG. 327	VEDI/SEE PAG. 326	VEDI/SEE PAG. 326

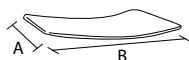
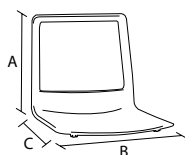
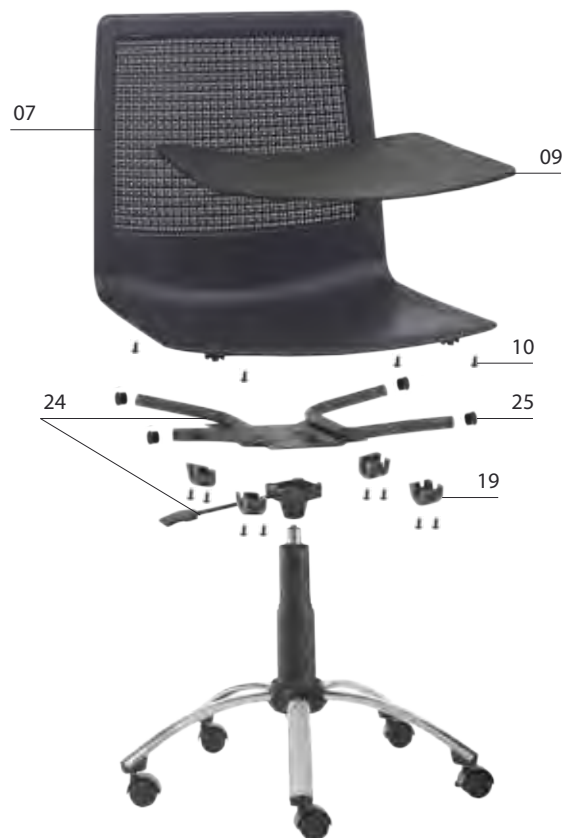

24 FEEL-SUPPORTO GIREVOLE A GAS PER SCOCCA FEEL FEEL-SWIVEL FRAME FOR FEEL SHELL

CODICE/CODE	FINITURA/FINISHING	Q.KIT	Q.MIN/PACK	A	B	KG.x1/WT.x1	VOL.x1/UNIT.VOL.
110903-033	■ NERO/BLACK	x1	10	385	295	1,70	mc. 0,004
110904-033	■ GRIGIO/GREY RAL7003	x1	10	385	295	1,70	mc. 0,004

25 TAPPO COPRITESTA ALETTATO TONDO D.18 NERO INNER CAPS-COVER HEAD D.18 BLACK

CODICE/CODE	FINITURA/FINISHING	Q.KIT
134103-180	■ NERO/BLACK	x4

07 FEEL-SCOCCA INTERA MODELLO FEEL FEEL-PLASTIC SHELL MODEL FEEL

CODICE/CODE	FINITURA/FINISHING	Q.KIT	Q.MIN/PACK	A	B	C	KG.x1/WT.x1	VOL.x1/UNIT.VOL.
133915-060	■ BLU/BLUE RAL5014	x1	10	420	450	430	1,70	mc. 0,02
133907-060	■ ARANCIO/ORANGE RAL2003	x1	10	420	450	430	1,70	mc. 0,02
133903-060	■ NERO/BLACK RAL9005	x1	10	420	450	430	1,70	mc. 0,02
133916-060	■ VERDE/GREEN PANTONE 7495EL	x1	10	420	450	430	1,70	mc. 0,02
133905-060	□ BIANCO/WHITE 218	x1	10	420	450	430	1,70	mc. 0,02
133904-060	■ GRIGIO/GREY RAL7003	x1	10	420	450	430	1,70	mc. 0,02
133907-059	■ SABBIA/SAND RAL1019	x1	10	420	450	430	1,70	mc. 0,02
133902-060	■ ROSSO/RED RAL527	x1	10	420	450	430	1,70	mc. 0,02
133903-059	■ NERO/BLACK RAL9005 autoestinguente/fire retardant	x1	10	420	450	430	1,70	mc. 0,02

19 FEEL-CONFEZIONE ACCESSORI PER SCOCCA FEEL PER TUBO D.18 FEEL-ACCESSORY PACK FOR SHELL FEEL FOR TUBE D.18

CODICE/CODE	FINITURA/FINISHING	Q.KIT	Q.MIN/PACK	KG.x1/WT.x1	VOL.x1/UNIT.VOL.
137015-060	■ BLU/BLUE RAL5014	x1	10	telaio tubo/tube frame	0,07 mc. 0,001
137007-060	■ ARANCIO/ORANGE RAL2003	x1	10	telaio tubo/tube frame	0,07 mc. 0,001
137003-060	■ NERO/BLACK RAL9005	x1	10	telaio tubo/tube frame	0,07 mc. 0,001
137016-060	■ VERDE/GREEN PANTONE 7495EL	x1	10	telaio tubo/tube frame	0,07 mc. 0,001
137005-060	□ BIANCO/WHITE 218	x1	10	telaio tubo/tube frame	0,07 mc. 0,001
137004-060	■ GRIGIO/GREY RAL7003	x1	10	telaio tubo/tube frame	0,07 mc. 0,001
137007-059	■ SABBIA/SAND RAL1019	x1	10	telaio tubo/tube frame	0,07 mc. 0,001
137002-060	■ ROSSO/RED RAL527	x1	10	telaio tubo/tube frame	0,07 mc. 0,001
137003-062	■ NERO/BLACK RAL9005 autoestinguente/fire retardant	x1	10	telaio tubo/tube frame	0,07 mc. 0,001

09 FEEL-PANNELLO SEDILE DA TAPPEZZARE FEEL-PANEL BACK FOR UPHOLSTERY

CODICE/CODE	FINITURA/FINISHING	Q.KIT	Q.MIN/PACK	A	B	KG.x1/WT.x1	VOL.x1/UNIT.VOL.
132203-059	■ NERO/BLACK	x1	20	400	440	0,6	mc. 0,003

10 VITE HILO TB+ 5x14 ZINCATA NERA (per fissare pannello sedile) SCREW HILO TB+ 5X14 FOR UPHOLSTERY SEAT PANEL

CODICE/CODE	FINITURA/FINISHING	Q.KIT
117803-155	■ NERO/BLACK	x8

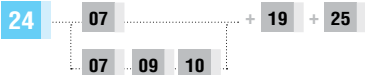

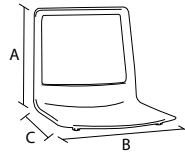

PER I COMPONENTI DELLA PANCA VAI A PAG. 337
FOR THE BENCH COMPONENTS GO TO PAGE 337

26	FEEL-SUPPORTO PER ATTACCO SCOCCA FEEL SU PANCA FEEL-BENCH FRAME FOR FEEL SHELL						
CODICE/CODE	FINITURA/FINISHING	Q. KIT	Q. MIN/PACK	A	B	KG. x1/WT.x1	VOL. x1/UNIT VOL.
110703-029	■ NERO/BLACK	x1	10	385	295	1,40	mc. 0,004

25	TAPPO COPRITESTA ALETTATO TONDO D.18 NERO INNER CAPS-COVER HEAD D.18 BLACK	
CODICE/CODE	FINITURA/FINISHING	Q. KIT
134103-180	■ NERO/BLACK	x4

07	FEEL-SCOCCA INTERA MODELLO FEEL FEEL-PLASTIC SHELL MODEL FEEL							
CODICE/CODE	FINITURA/FINISHING	Q. KIT	Q. MIN/PACK	A	B	C	KG. x1/WT.x1	VOL. x1/UNIT VOL.
133915-060	■ BLU/BLUE RAL5014	x1	10	420	450	430	1,70	mc. 0,02
133907-060	■ ARANCIO/ORANGE RAL2003	x1	10	420	450	430	1,70	mc. 0,02
133903-060	■ NERO/BLACK RAL9005	x1	10	420	450	430	1,70	mc. 0,02
133916-060	■ VERDE/GREEN PANTONE 7495EL	x1	10	420	450	430	1,70	mc. 0,02
133905-060	□ BIANCO/WHITE 218	x1	10	420	450	430	1,70	mc. 0,02
133904-060	■ GRIGIO/GREY RAL7003	x1	10	420	450	430	1,70	mc. 0,02
133907-059	■ SABBIA/SAND RAL1019	x1	10	420	450	430	1,70	mc. 0,02
133902-060	■ ROSSO/RED RAL527	x1	10	420	450	430	1,70	mc. 0,02
133903-059	■ NERO/BLACK RAL9005 autoestinguente/fire retardant	x1	10	420	450	430	1,70	mc. 0,02

19	FEEL-CONFEZIONE ACCESSORI PER SCOCCA FEEL PER TUBO D.18 FEEL-ACCESSORY PACK FOR SHELL FEEL FOR TUBE D.18				
CODICE/CODE	FINITURA/FINISHING	Q. KIT	Q. MIN/PACK	KG. x1/WT.x1	VOL. x1/UNIT VOL.
137015-060	■ BLU/BLUE RAL5014	x1	10	telaio tubo/tube frame	0,07 mc. 0,001
137007-060	■ ARANCIO/ORANGE RAL2003	x1	10	telaio tubo/tube frame	0,07 mc. 0,001
137003-060	■ NERO/BLACK RAL9005	x1	10	telaio tubo/tube frame	0,07 mc. 0,001
137016-060	■ VERDE/GREEN PANTONE 7495EL	x1	10	telaio tubo/tube frame	0,07 mc. 0,001
137005-060	□ BIANCO/WHITE 218	x1	10	telaio tubo/tube frame	0,07 mc. 0,001
137004-060	■ GRIGIO/GREY RAL7003	x1	10	telaio tubo/tube frame	0,07 mc. 0,001
137007-059	■ SABBIA/SAND RAL1019	x1	10	telaio tubo/tube frame	0,07 mc. 0,001
137002-060	■ ROSSO/RED RAL527	x1	10	telaio tubo/tube frame	0,07 mc. 0,001
137003-062	■ NERO/BLACK RAL9005 autoestinguente/fire retardant	x1	10	telaio tubo/tube frame	0,07 mc. 0,001

09	FEEL-PANNELLO SEDILE DA TAPPEZZARE FEEL-PANEL BACK FOR UPHOLSTERY						
CODICE/CODE	FINITURA/FINISHING	Q. KIT	Q. MIN/PACK	A	B	KG. x1/WT.x1	VOL. x1/UNIT VOL.
132203-059	■ NERO/BLACK	x1	20	400	440	0,6	mc. 0,003

10	VITE HILO TB+ 5x14 ZINCATA NERA (per fissare pannello sedile) SCREW HILO TB+ 5X14 FOR UPHOLSTERY SEAT PANEL	
CODICE/CODE	FINITURA/FINISHING	Q. KIT
117803-155	■ NERO/BLACK	x8

OPTIONAL GAMBA
LEG OPTIONAL







RACE



SLIDE

4 LEGS

SWIVEL

BENCH



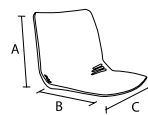
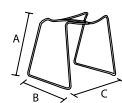
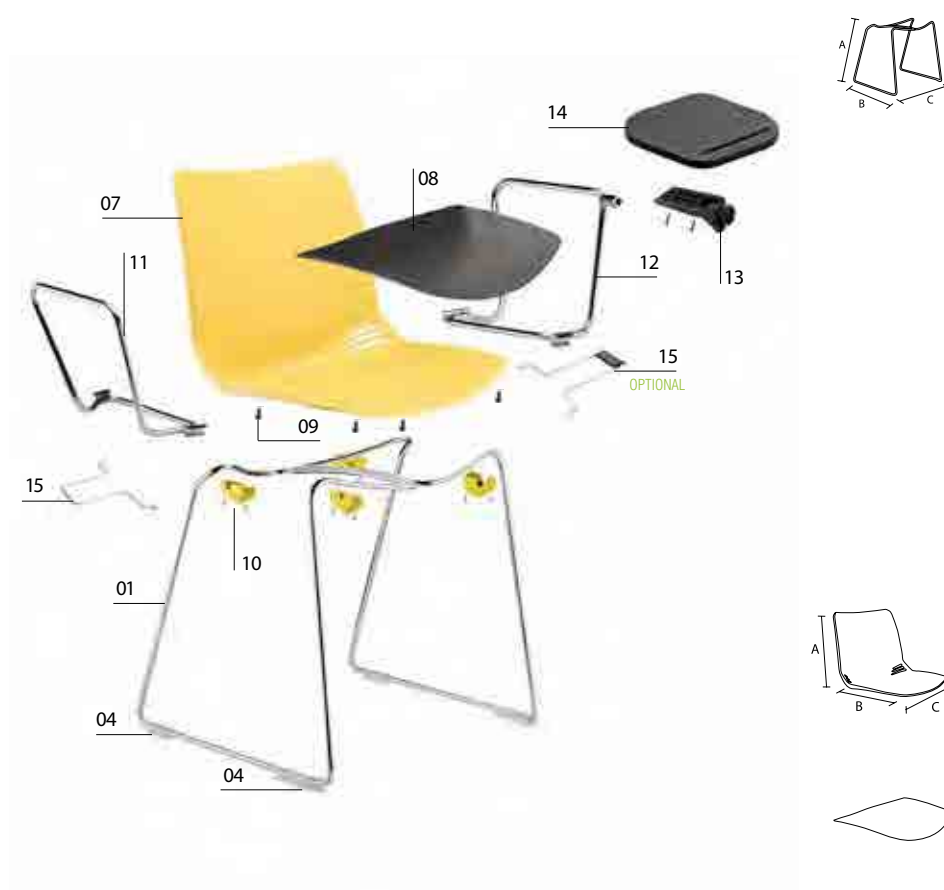

01 RACE-TELAIO SLITTA IN TONDINO PER SCOCCA SENZA TAPPI

RACE-SLIDE WIRE FRAME FOR SHELL WITHOUT CAPS

CODICE/CODE	FINITURA/FINISHING	Q.KIT	Q. MIN/PACK	A	B	C	KG.x1/WT.x1	VOL.x1/UNIT VOL.
113407-065	■ MARRONE/BROWN RAL8022	x1	100	460	500	470	3,20	mc. 0,026
113404-065	■ GRIGIO/GRAY RAL7003	x1	100	460	500	470	3,20	mc. 0,026
113405-065	□ AVORIO/IVORY RAL1013	x1	100	460	500	470	3,20	mc. 0,026
113410-065	■ CROMATO/CHROME	x1	100	460	500	470	3,20	mc. 0,026

02 BASE PIANA A PINZA IN PE PER TONDO

CLIPS BASE FOR TUBE

CODICE/CODE	FINITURA/FINISHING	Q.KIT
134006-020	□ NEUTRO/NEUTRAL	x4

03 BASE PIANA A PINZA DOPPIA IN PE PER TONDO PER UNIONE SEDIE

DOUBLE FLAT CLIP BASE FOR TUBE

CODICE/CODE	FINITURA/FINISHING	Q.KIT
134006-021	□ NEUTRO/NEUTRAL	x4

04 BTF-KIT PIEDINI

BTf-KIT FEET

CODICE/CODE	FINITURA/FINISHING	Q.KIT	Q. MIN/PACK	KG.x1/WT.x1
134306-001	□ NEUTRO/NEUTRAL	x1	100	0,05

05 BTFA-KIT PIEDINI CON GANCI

BTFA-KIT FEET WITH HOOKS

CODICE/CODE	FINITURA/FINISHING	Q.KIT	Q. MIN/PACK	KG.x1/WT.x1
134306-002	□ NEUTRO/NEUTRAL	x1	100	0,06

06 PPTF-TAPPO PER FISSAGGIO PAVIMENTO

PPTF-CAP FOR FIXING TO THE FLOOR

CODICE/CODE	FINITURA/FINISHING	Q.KIT	Q. MIN/PACK	KG.x1/WT.x1
134306-003	□ NEUTRO/NEUTRAL	x2	100	0,03

07 RACE-SCOCCA INTERNA MODELLO RACE

RACE-PLASTIC SHELL MODEL RACE

CODICE/CODE	FINITURA/FINISHING	Q.KIT	Q. MIN/PACK	A	B	C	KG.x1/WT.x1	VOL.x1/UNIT VOL.
133915-012	■ BLU/BLUE RAL5002	x1	10	380	410	450	1,60	mc. 0,02
133907-012	■ ARANCIO/ORANGE RAL2009	x1	10	380	410	450	1,60	mc. 0,02
133914-012	■ VIOLA/PURPLE 145	x1	10	380	410	450	1,60	mc. 0,02
133916-012	■ VERDE/GREEN 736	x1	10	380	410	450	1,60	mc. 0,02
133905-012	□ AVORIO/IVORY RAL1013	x1	10	380	410	450	1,60	mc. 0,02
133904-012	■ GRIGIO/GRAY RAL7003	x1	10	380	410	450	1,60	mc. 0,02
133908-012	■ GIALLO/YELLOW RAL1012	x1	10	380	410	450	1,60	mc. 0,02
133907-013	■ MARRONE/BROWN RAL8022	x1	10	380	410	450	1,60	mc. 0,02

08 RACE-PANNELLO SEDILE DA TAPPEZZARE

RACE-BACK PANEL FOR UPHOLSTERY

CODICE/CODE	FINITURA/FINISHING	Q.KIT	Q. MIN/PACK	KG.x1/WT.x1	VOL.x1/UNIT VOL.
132203-049	■ NERO/BLACK	x1	20	0,53	mc. 0,003

09 VITE HILO TBL+ FR. D. 5X14 ZINCATA NERA (PER FISSARE PANNELLO SEDILE)

SCREW TBL+FR.HILO D.5X14 ZINC.BLACK (TO FIX SEAT PANEL)

CODICE/CODE	FINITURA/FINISHING	Q.KIT
117803-156	■ NERO/BLACK	x4

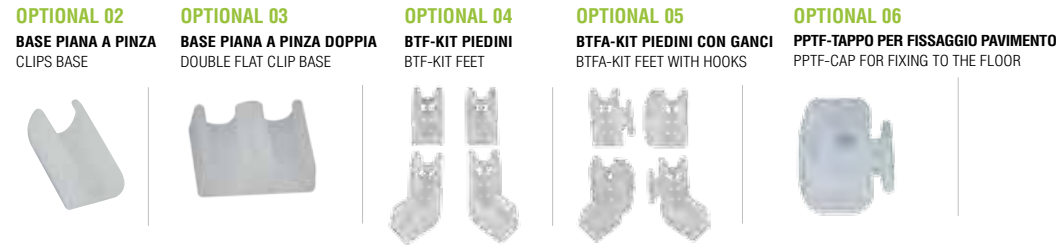
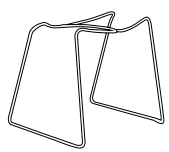
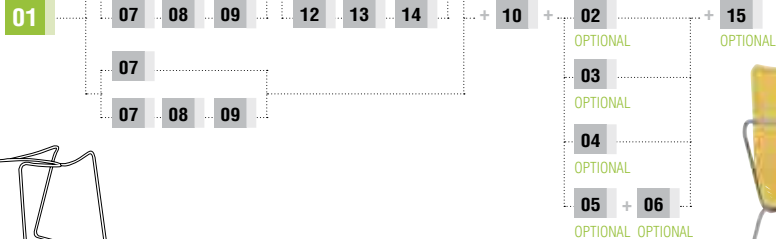

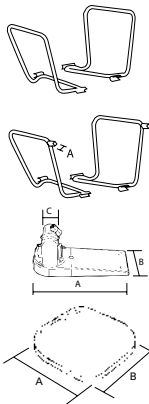

10 RACE-CONFEZIONE ACCESSORI PER SCOCCA RACE
RACE-ACCESSORY PACK FOR SHELL RACE

CODICE/CODE	FINITURA/FINISHING	Q. KIT	Q. MIN/PACK	KG. x1/WT.x1	VOL. x1/UNIT VOL.
137015-006	■ BLU/BLUE RAL5002	x1	10	0,85	mc. 0,0001
137007-007	■ ARANCIO/ORANGE RAL2009	x1	10	0,85	mc. 0,0001
137014-006	■ VIOLA/PURPLE 145	x1	10	0,85	mc. 0,0001
137016-006	■ VERDE/GREEN 736	x1	10	0,85	mc. 0,0001
137005-006	□ AVORIO/IVORY RAL1013	x1	10	0,85	mc. 0,0001
137004-006	■ GRIGIO/GREY RAL7003	x1	10	0,85	mc. 0,0001
137008-006	■ GIALLO/YELLOW RAL1012	x1	10	0,85	mc. 0,0001
137007-008	■ MARRONE/BROWN RAL8022	x1	10	0,85	mc. 0,0001

11 RACE-BRACCIOLO PER SLITTA TONDINO
RACE-ARM FOR SLIDE WIRE FRAME

CODICE/CODE	FINITURA/FINISHING	Q. KIT	Q. MIN/PACK	KG. x1/WT.x1	VOL. x1/UNIT VOL.
111710-060	■ CROMATO/CHROME destro/right	x1	10	0,90	mc. 0,002
111710-061	■ CROMATO/CHROME sinistro/left	x1	10	0,90	mc. 0,002

12 RACE-BRACCIOLO PER SLITTA TONDINO CON AGGANCIO TAVOLETTA
RACE-ARM FOR SLIDE WIRE FRAME WITH TABLET

CODICE/CODE	FINITURA/FINISHING	Q. KIT	Q. MIN/PACK	A	KG. x1/WT.x1	VOL. x1/UNIT VOL.
111710-071	■ CROMATO/CHROME destro/right	x1	10	15x15	0,95	mc. 0,002
111710-069	■ CROMATO/CHROME sinistro/left	x1	10	15x15	0,95	mc. 0,002

13 SPT2-SNODO PER TAVOLETTA IN PLASTICA
SPT2-MECHANISM FOR WRITING TABLET IN PLASTIC

CODICE/CODE	FINITURA/FINISHING	Q. KIT	Q. MIN/PACK	A	B	C	KG. x1/WT.x1	VOL. x1/UNIT VOL.
134003-039	■ NERO/BLACK	x1	20	180	66	15x15	0,35	mc. 0,0006

14 TLT2-TAVOLETTA IN TERMOPLASTICO OVALE SPESSORE 16 MM PER BRACCIOLO DESTRO E SINISTRO
TLT2-WRITING TABLET IN OVAL PLASTIC THICKNESS 16 MM FOR LEFT AND RIGHT ARMS

CODICE/CODE	FINITURA/FINISHING	Q. KIT	Q. MIN/PACK	A	B	KG. x1/WT.x1	VOL. x1/UNIT VOL.
134003-040	■ NERO/BLACK	x1	20	271	271	0,40	mc. 0,002

15 RACE-COPPIA AGGANCI LATERALE IN TONDINO + PLASTICA
RACE-PAIR SIDE WIRE HOOKS + PLASTIC

CODICE/CODE	FINITURA/FINISHING	Q. KIT	Q. MIN/PACK	KG. x1/WT.x1	VOL. x1/UNIT VOL.
113410-004	■ CROMATO/CHROME	x1	50	0,15	mc. 0,0004

OPTIONAL 15

COPPIA AGGANCIO LATERALE
PAIR SIDE WIRE HOOKS



RACE-CARRELLO PORTASEDIE CON ACCESSORI
RACE-TROLLEY FOR CHAIRS WITH ACCESSORIES

CODICE/CODE	FINITURA/FINISHING	Q. KIT	KG. x1/WT.x1
112703-012	■ NERO/BLACK	x1	10,50

OPTIONAL

TAVOLETTA TLT
TLT TABLET



VEDI/SEE PAG. 327

TAVOLETTA TLT2
TLT2 TABLET



VEDI/SEE PAG. 327

TAVOLETTA TLT3
TLT3 TABLET



VEDI/SEE PAG. 327

TAVOLETTA BEAN
BEAN TABLET



VEDI/SEE PAG. 327

TAVOLETTA TL01
TL01 TABLET



VEDI/SEE PAG. 327

SNODO TAVOLETTA SPT2
SPT2 MECHANISM TABLET



VEDI/SEE PAG. 326

SNODO ANTIPANICO
MECHANISM ANTIPANIC



VEDI/SEE PAG. 326

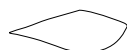
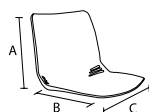
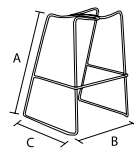
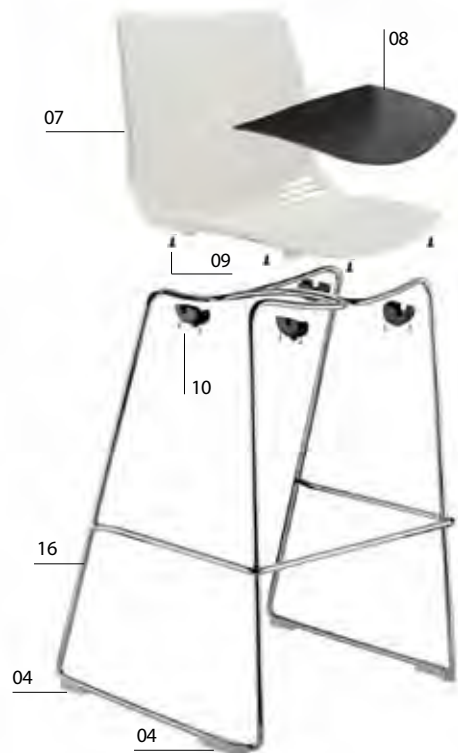

16 RACE-SGABELLO ALTO IN TONDINO PER SCOCCA SENZA TAPPI
RACE-WIRE HIGH BAR STOOL FOR SHELL WITHOUT CAPS

CODICE/CODE	FINITURA/FINISHING	Q. KIT	Q. MIN/PACK	A	B	C	KG. x1/WT.x1	VOL. x1/UNIT VOL.
113410-066	■ CROMATO/CHROME	x1	50	700	500	550	5,00	mc. 0,08

02 BASE PIANA A PINZA IN PE PER TONDO
CLIPS BASE FOR TUBE

CODICE/CODE	FINITURA/FINISHING	Q. KIT
134006-020	□ NEUTRO/NEUTRAL	x4

04 BTF-KIT PIEDINI
BTF-KIT FEET

CODICE/CODE	FINITURA/FINISHING	Q. KIT	Q. MIN/PACK	KG. x1/WT.x1
134306-001	□ NEUTRO/NEUTRAL	x1	100	0,05

07 RACE-SCOCCA INTERA MODELLO RACE
RACE-PLASTIC SHELL MODEL RACE

CODICE/CODE	FINITURA/FINISHING	Q. KIT	Q. MIN/PACK	A	B	C	KG. x1/WT.x1	VOL. x1/UNIT VOL.
133915-012	■ BLU/BLUE	x1	10	380	410	450	1,60	mc. 0,02
133907-012	■ ARANCIO/ORANGE	x1	10	380	410	450	1,60	mc. 0,02
133914-012	■ VIOLA/PURPLE	x1	10	380	410	450	1,60	mc. 0,02
133916-012	■ VERDE/GREEN	x1	10	380	410	450	1,60	mc. 0,02
133905-012	□ AVORIO/IVORY	x1	10	380	410	450	1,60	mc. 0,02
133904-012	■ GRIGIO/GREY	x1	10	380	410	450	1,60	mc. 0,02
133908-012	■ GIALLO/YELLOW	x1	10	380	410	450	1,60	mc. 0,02
133907-013	■ MARRONE/BROWN	x1	10	380	410	450	1,60	mc. 0,02

08 RACE-PANNELLO SEDILE DA TAPPEZZARE
RACE-BACK PANEL FOR UPHOLSTERY

CODICE/CODE	FINITURA/FINISHING	Q. KIT	Q. MIN/PACK	KG. x1/WT.x1	VOL. x1/UNIT VOL.
132203-049	■ NERO/BLACK	x1	20	0,53	mc. 0,003

09 VITE HILO TBL+ FR. D. 5X14 ZINCATA NERA (PER FISSARE PANNELLO SEDILE)
SCREW TBL+FR.HILO D.5X14 ZINC. BLACK (TO FIX SEAT PANEL)

CODICE/CODE	FINITURA/FINISHING	Q. KIT
117803-156	■ NERO/BLACK	x4

10 RACE-CONFEZIONE ACCESSORI PER SCOCCA RACE
RACE-ACCESSORY PACK FOR SHELL RACE

CODICE/CODE	FINITURA/FINISHING	Q. KIT	Q. MIN/PACK	KG. x1/WT.x1	VOL. x1/UNIT VOL.
137015-006	■ BLU/BLUE	x1	10	0,85	mc. 0,0001
137007-007	■ ARANCIO/ORANGE	x1	10	0,85	mc. 0,0001
137014-006	■ VIOLA/PURPLE	x1	10	0,85	mc. 0,0001
137016-006	■ VERDE/GREEN	x1	10	0,85	mc. 0,0001
137005-006	□ AVORIO/IVORY	x1	10	0,85	mc. 0,0001
137004-006	■ GRIGIO/GREY	x1	10	0,85	mc. 0,0001
137008-006	■ GIALLO/YELLOW	x1	10	0,85	mc. 0,0001
137007-008	■ MARRONE/BROWN	x1	10	0,85	mc. 0,0001

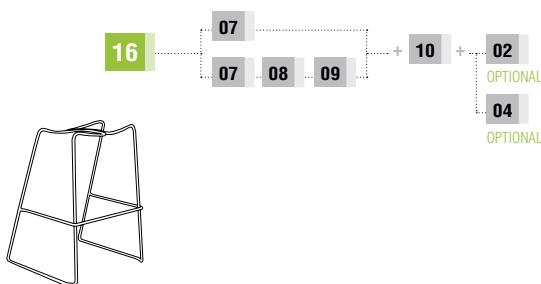

OPTIONAL 02
BASE PIANA A PINZA
CLIPS BASE



OPTIONAL 04
BTF-KIT PIEDINI
BTF-KIT FEET





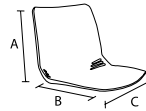
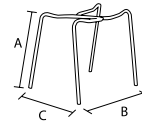

17 RACE-TELAIO 4 GAMBE IN TUBO D.18 SENZA TAPPI
RACE-4 LEGS FRAME D.18 WITHOUT CAPS

CODICE/CODE	FINITURA/FINISHING	Q.KIT	Q.MIN/PACK	A	B	C	KG.x1/WT.x1	VOL.x1/UNIT VOL.
112703-015	■ NERO/BLACK	x1	150	460	500	470	2,00	mc. 0,014
112707-015	■ MARRONE/BROWN RAL8022	x1	150	460	500	470	2,00	mc. 0,014
112704-015	■ GRIGIO/GRAY RAL7003	x1	150	460	500	470	2,00	mc. 0,014
112705-015	□ AVORIO/IVORY RAL1013	x1	150	460	500	470	2,00	mc. 0,014
112710-015	■ CROMATO/CHROME	x1	150	460	500	470	2,00	mc. 0,014

18 PUNTALE ALETTATO TONDO D.18 NERO
INNER CAP FOR LEGS D.18 BLACK

CODICE/CODE	FINITURA/FINISHING	Q.KIT
134203-180	■ NERO/BLACK	x4
134205-181	□ BIANCO/WHITE	x4

07 RACE-SCocca INTERA MODELLO RACE
RACE-PLASTIC SHELL MODEL RACE

CODICE/CODE	FINITURA/FINISHING	Q.KIT	Q.MIN/PACK	A	B	C	KG.x1/WT.x1	VOL.x1/UNIT VOL.
133915-012	■ BLU/BLUE RAL5002	x1	10	380	410	450	1,60	mc. 0,02
133907-012	■ ARANCIO/ORANGE RAL2009	x1	10	380	410	450	1,60	mc. 0,02
133914-012	■ VIOLA/PURPLE 145	x1	10	380	410	450	1,60	mc. 0,02
133916-012	■ VERDE/GREEN 736	x1	10	380	410	450	1,60	mc. 0,02
133905-012	□ AVORIO/IVORY RAL1013	x1	10	380	410	450	1,60	mc. 0,02
133904-012	■ GRIGIO/GRAY RAL7003	x1	10	380	410	450	1,60	mc. 0,02
133908-012	■ GIALLO/YELLOW RAL1012	x1	10	380	410	450	1,60	mc. 0,02
133907-013	■ MARRONE/BROWN RAL8022	x1	10	380	410	450	1,60	mc. 0,02

08 RACE-PANNELLO SEDILE DA TAPPEZZARE
RACE-BACK PANEL FOR UPHOLSTERY

CODICE/CODE	FINITURA/FINISHING	Q.KIT	Q.MIN/PACK	KG.x1/WT.x1	VOL.x1/UNIT VOL.
132203-049	■ NERO/BLACK	x1	20	0,53	mc. 0,003

09 VITE HILO TBL+ FR. D.5X14 ZINCATA NERA(PER FISSARE PANNELLO SEDILE)
SCREW TBL+FR.HILO D.5X14 ZINC.BLACK(FOR FIX SEAT PANEL)

CODICE/CODE	FINITURA/FINISHING	Q.KIT
117803-156	■ NERO/BLACK	x4

19 RACE-CONFEZIONE ACCESSORI PER SCocca RACE
RACE-ACCESSORY PACK FOR SHELL RACE

CODICE/CODE	FINITURA/FINISHING	Q.KIT	Q.MIN/PACK	KG.x1/WT.x1	VOL.x1/UNIT VOL.
137015-005	■ BLU/BLUE RAL5002	x1	10	telaio tubo/tube frame	0,85 mc. 0,0001
137007-005	■ ARANCIO/ORANGE RAL2009	x1	10	telaio tubo/tube frame	0,85 mc. 0,0001
137014-005	■ VIOLA/PURPLE 145	x1	10	telaio tubo/tube frame	0,85 mc. 0,0001
137016-005	■ VERDE/GREEN 736	x1	10	telaio tubo/tube frame	0,85 mc. 0,0001
137005-005	□ AVORIO/IVORY RAL1013	x1	10	telaio tubo/tube frame	0,85 mc. 0,0001
137004-005	■ GRIGIO/GRAY RAL7003	x1	10	telaio tubo/tube frame	0,85 mc. 0,0001
137008-005	■ GIALLO/YELLOW RAL1012	x1	10	telaio tubo/tube frame	0,85 mc. 0,0001
137007-006	■ MARRONE/BROWN RAL8022	x1	10	telaio tubo/tube frame	0,85 mc. 0,0001

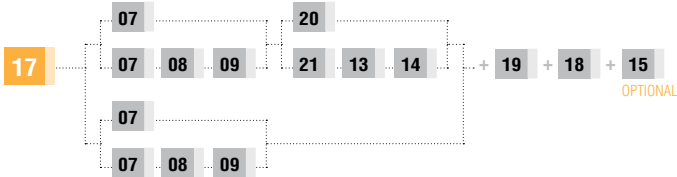

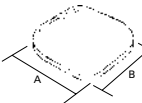
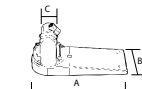

20 RACE-BRACCIOLO IN TUBO PER 4 GAMBE							
RACE-ARM TUBE FOR 4 LEGS FRAME							
CODICE/CODE	FINITURA/FINISHING		Q. KIT	Q. MIN/PACK		KG. x1/WT.x1	VOL. x1/UNIT VOL.
111710-063	■ CROMATO/CHROME	destra/right	x1	5		1,15	mc. 0,004
111710-062	■ CROMATO/CHROME	sinistro/left	x1	5		1,15	mc. 0,004

21 RACE-BRACCIOLO IN TUBO PER 4 GAMBE CON AGGANCIO TAVOLETTA							
RACE-ARM TUBE FOR 4 LEGS FRAME WITH TABLET							
CODICE/CODE	FINITURA/FINISHING		Q. KIT	Q. MIN/PACK	A	KG. x1/WT.x1	VOL. x1/UNIT VOL.
111710-073	■ CROMATO/CHROME	destra/right	x1	5	15x15	1,20	mc. 0,004
111710-072	■ CROMATO/CHROME	sinistro/left	x1	5	15x15	1,20	mc. 0,004

13 SPT2-SNODO PER TAVOLETTA IN PLASTICA									
SPT2-MECHANISM FOR WRITING TABLET IN PLASTIC									
CODICE/CODE	FINITURA/FINISHING		Q. KIT	Q. MIN/PACK	A	B	C	KG. x1/WT.x1	VOL. x1/UNIT VOL.
134003-039	■ NERO/BLACK		x1	20	180	66	15x15	0,35	mc. 0,0006

14 TLT2-TAVOLETTA IN TERMOPLASTICO OVALE SPESSORE 16 MM PER BRACCIOLO DESTRO E SINISTRO									
TLT2-WRITING TABLET IN OVAL PLASTIC THICKNESS 16 MM FOR LEFT AND RIGHT ARMS									
CODICE/CODE	FINITURA/FINISHING		Q. KIT	Q. MIN/PACK	A	B	KG. x1/WT.x1	VOL. x1/UNIT VOL.	
134003-040	■ NERO/BLACK		x1	20	271	271		0,40	mc. 0,002

15 RACE-COPPIA AGGANCI LATERALE IN TONDINO + PLASTICA									
RACE-PAIR SIDE WIRE HOOKS + PLASTIC									
CODICE/CODE	FINITURA/FINISHING		Q. KIT	Q. MIN/PACK		KG. x1/WT.x1	VOL. x1/UNIT VOL.		
113410-004	■ CROMATO/CHROME		x1	50				0,15	mc. 0,0004

OPTIONAL 15

COPPIA AGGANCIO LATERALE
PAIR SIDE WIRE HOOKS



RACE-CARRELLO PORTASEDIE CON ACCESSORI			
RACE-TROLLEY FOR CHAIRS WITH ACCESSORIES			
CODICE/CODE	FINITURA/FINISHING	Q. KIT	KG. x1/WT.x1
112703-012	■ NERO/BLACK	x1	10,50

OPTIONAL

TAVOLETTA TLT TLT TABLET	TAVOLETTA TLT2 TLT2 TABLET	TAVOLETTA TLT3 TLT3 TABLET	TAVOLETTA BEAN BEAN TABLET	TAVOLETTA TL01 TL01 TABLET	SNODO TAVOLETTA SPT2 SPT2 MECHANISM TABLET	SNODO ANTIPANICO MECHANISM ANTIPANIC
						
VEDI/SEE PAG. 327	VEDI/SEE PAG. 327	VEDI/SEE PAG. 327	VEDI/SEE PAG. 327	VEDI/SEE PAG. 327	VEDI/SEE PAG. 326	VEDI/SEE PAG. 326

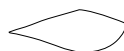
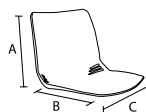
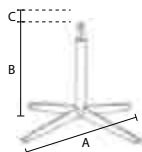
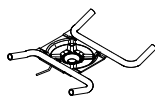

22 RACE-SUPPORTO GIREVOLE A GAS PER SCOCCA RACE						
RACE-SWIVEL FRAME FOR RACE SHELL						
CODICE/CODE	FINITURA/FINISHING	Q. KIT	Q. MIN/PACK	KG. x1/WT.x1	VOL. x1/UNIT VOL.	
110903-070	■ NERO/BLACK	x1	8	1,40	mc. 0,005	
110904-070	■ GRIGIO/GREY RAL7003	x1	8	1,40	mc. 0,005	

23 TAPPO COPRITESTA ALETTATO TONDO D.18 NERO						
INNER CAPS-COVER HEAD D.18 BLACK						
CODICE/CODE	FINITURA/FINISHING	Q. KIT				
134103-180	■ NERO/BLACK	x4				

25 B20-BASE CON POMPA A GAS ASSEMBLATA								
B20-BASE WITH GAS PUMP ASSEMBLED								
CODICE/CODE	FINITURA/FINISHING	Q. KIT	Q. MIN/PACK	A	B	C	KG. x1/WT.x1	VOL. x1/UNIT VOL.
110210-080	■ CROMATO/CHROME	x1	50	700	325	75	4,80	mc. 0,03

07 RACE-SCOCCA INTERA MODELLO RACE								
RACE-PLASTIC SHELL MODEL RACE								
CODICE/CODE	FINITURA/FINISHING	Q. KIT	Q. MIN/PACK	A	B	C	KG. x1/WT.x1	VOL. x1/UNIT VOL.
133915-012	■ BLU/BLUE RAL5002	x1	10	380	410	450	1,60	mc. 0,02
133907-012	■ ARANCIO/ORANGE RAL2009	x1	10	380	410	450	1,60	mc. 0,02
133914-012	■ VIOLA/PURPLE 145	x1	10	380	410	450	1,60	mc. 0,02
133916-012	■ VERDE/GREEN 736	x1	10	380	410	450	1,60	mc. 0,02
133905-012	□ AVORIO/IVORY RAL1013	x1	10	380	410	450	1,60	mc. 0,02
133904-012	■ GRIGIO/GREY RAL7003	x1	10	380	410	450	1,60	mc. 0,02
133908-012	■ GIALLO/YELLOW RAL1012	x1	10	380	410	450	1,60	mc. 0,02
133907-013	■ MARRONE/BROWN RAL8022	x1	10	380	410	450	1,60	mc. 0,02

08 RACE-PANNELLO SEDILE DA TAPPEZZARE						
RACE-BACK PANEL FOR UPHOLSTERY						
CODICE/CODE	FINITURA/FINISHING	Q. KIT	Q. MIN/PACK	KG. x1/WT.x1	VOL. x1/UNIT VOL.	
132203-049	■ NERO/BLACK	x1	20	0,53	mc. 0,003	

09 VITE HILO TBL+ FR. D.5X14 ZINCATA NERA (PER FISSARE PANNELLO SEDILE)						
SCREW TBL+FR.HILO D.5X14 ZINC. BLACK (TO FIX SEAT PANEL)						
CODICE/CODE	FINITURA/FINISHING	Q. KIT				
117803-156	■ NERO/BLACK	x4				

19 RACE-CONFEZIONE ACCESSORI PER SCOCCA RACE						
RACE-ACCESSORY PACK FOR SHELL RACE						
CODICE/CODE	FINITURA/FINISHING	Q. KIT	Q. MIN/PACK		KG. x1/WT.x1	VOL. x1/UNIT VOL.
137015-005	■ BLU/BLUE RAL5002	x1	10	telaio tubo/tube frame	0,85	mc. 0,0001
137007-005	■ ARANCIO/ORANGE RAL2009	x1	10	telaio tubo/tube frame	0,85	mc. 0,0001
137014-005	■ VIOLA/PURPLE 145	x1	10	telaio tubo/tube frame	0,85	mc. 0,0001
137016-005	■ VERDE/GREEN 736	x1	10	telaio tubo/tube frame	0,85	mc. 0,0001
137005-005	□ AVORIO/IVORY RAL1013	x1	10	telaio tubo/tube frame	0,85	mc. 0,0001
137004-005	■ GRIGIO/GREY RAL7003	x1	10	telaio tubo/tube frame	0,85	mc. 0,0001
137008-005	■ GIALLO/YELLOW RAL1012	x1	10	telaio tubo/tube frame	0,85	mc. 0,0001
137007-006	■ MARRONE/BROWN RAL8022	x1	10	telaio tubo/tube frame	0,85	mc. 0,0001

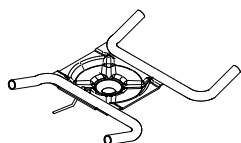
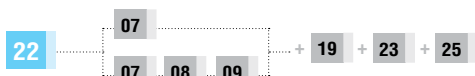



PER I COMPONENTI DELLA PANCA VAI A PAG. 337
FOR THE BENCH COMPONENTS GO TO PAGE 337

24	RACE-SUPPORTO PER ATTACCO SCOCCA RACE SU PANCA		Q. KIT	Q. MIN/PACK	KG. x1/WT.x1	VOL. x1/UNIT VOL.
	RACE-BENCH FRAME FOR RACE SHELL					
	CODICE/CODE	FINITURA/FINISHING				
	110703-210	■ NERO/BLACK	x1	15	1,30	mc. 0,004

23
RACE

OPTIONAL GAMBA
LEG OPTIONAL

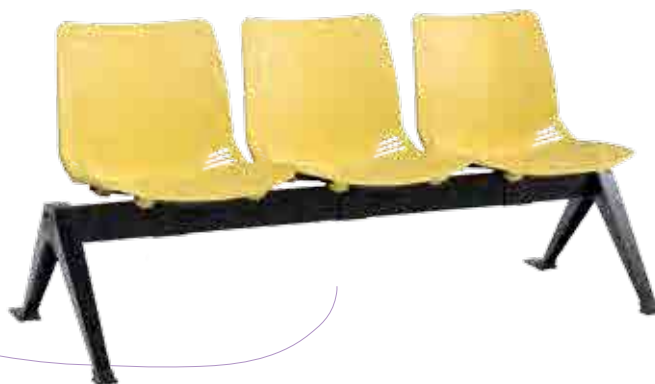
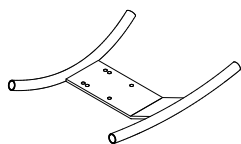
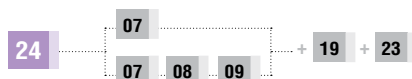





SLIDE



4 LEGS



SWIVEL



BIFMA

ALBA  



IN ESCLUSIVA PER L'ITALIA

Q5



BENCH



Q5 SLIDE

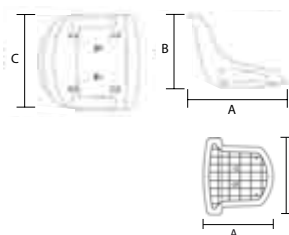
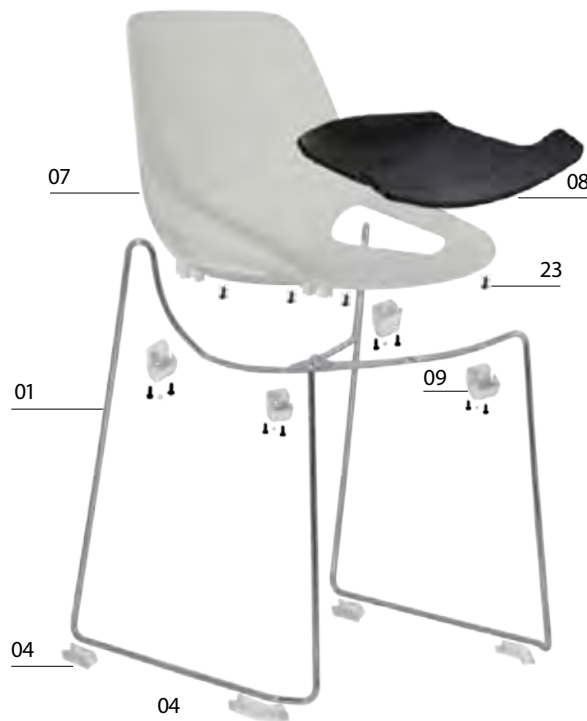
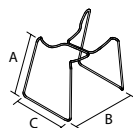

01	Q5-TELAIO SLITTA IN TONDINO PER SCOCCA SENZA TAPPI Q5-SLIDE WIRE FRAME FOR SHELL WITHOUT CAPS								
CODICE/CODE	FINITURA/FINISHING	Q.KIT	Q.MIN/PACK	A	B	C	KG.x1/WT.x1	VOL.x1/UNIT VOL.	
113410-012	■ CROMATO/CHROME	x1	100	450	550	510	4,20	mc. 0,04	
02	BASE PIANA A PINZA IN PE PER TONDO CLIPS BASE FOR TUBE								
CODICE/CODE	FINITURA/FINISHING	Q.KIT							
134006-020	□ NEUTRO/NEUTRAL	x4							
03	BASE PIANA A PINZA DOPPIA IN PE PER TONDO PER UNIONE SEDIE DOUBLE FLAT CLIP BASE FOR TUBE								
CODICE/CODE	FINITURA/FINISHING	Q.KIT							
134006-021	□ NEUTRO/NEUTRAL	x4							
04	BTF-KIT PIEDINI BTF-KIT FEET								
CODICE/CODE	FINITURA/FINISHING	Q.KIT	Q.MIN/PACK				KG.x1/WT.x1		
134306-001	□ NEUTRO/NEUTRAL	x1	100				0,05		
05	BTFA-KIT PIEDINI CON GANCI BTFA-KIT FEET WITH HOOKS								
CODICE/CODE	FINITURA/FINISHING	Q.KIT	Q.MIN/PACK				KG.x1/WT.x1		
134306-002	□ NEUTRO/NEUTRAL	x1	100				0,06		
06	PPTF-TAPPO PER FISSAGGIO PAVIMENTO PPTF-CAP FOR FIXING TO THE FLOOR								
CODICE/CODE	FINITURA/FINISHING	Q.KIT	Q.MIN/PACK				KG.x1/WT.x1		
134306-003	□ NEUTRO/NEUTRAL	x2	100				0,03		
07	Q5-SCOCCA INTERA MODELLO Q5 Q5-SHELL MODEL Q5								
CODICE/CODE	FINITURA/FINISHING	Q.KIT	Q.MIN/PACK	A	B	C	KG.x1/WT.x1	VOL.x1/UNIT VOL.	
133903-035	■ MARRONE/BROWN RAL8022	x1	10	400	400	470	1,60	mc. 0,02	
133905-035	□ AVORIO/IVORY RAL1013	x1	10	400	400	470	1,60	mc. 0,02	
133908-035	□ GIALLO/YELLOW RAL1012	x1	10	400	400	470	1,60	mc. 0,02	
133904-035	■ GRIGIO/GREY RAL7003	x1	10	400	400	470	1,60	mc. 0,02	
08	Q5-PANNELLO SEDILE DA TAPPEZZARE Q5-PANEL BACK FOR UPHOLSTERY								
CODICE/CODE	FINITURA/FINISHING	Q.KIT	Q.MIN/PACK	A	B		KG.x1/WT.x1	VOL.x1/UNIT VOL.	
132203-048	■ NERO/BLACK	x1	20	390	420		0,52	mc. 0,003	
09	Q5-CONFEZIONE ACCESSORI PER SCOCCA Q5 Q5-PACKAGING ACCESSORIES FOR SHELL Q5								
CODICE/CODE	FINITURA/FINISHING	Q.KIT	Q.MIN/PACK				KG.x1/WT.x1	VOL.x1/UNIT VOL.	
137003-004	■ MARRONE/BROWN RAL8022	x1	10	telaio in tondino/wire frame			0,085	mc. 0,00	
137005-004	□ AVORIO/IVORY RAL1013	x1	10	telaio in tondino/wire frame			0,085	mc. 0,00	
137008-004	□ GIALLO/YELLOW RAL1012	x1	10	telaio in tondino/wire frame			0,085	mc. 0,00	
137004-004	■ GRIGIO/GREY RAL7003	x1	10	telaio in tondino/wire frame			0,085	mc. 0,00	
23	VITE TBL +FR 5x14 PER PANNELLO DA TAPPEZZARE SCREW TBL +FR 5X14 FOR UPHOLSTERY PANEL								
CODICE/CODE	FINITURA/FINISHING	Q.KIT							
117803-156	■ NERO/BLACK	x4							

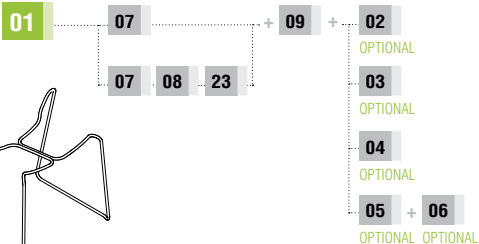

OPTIONAL 02
BASE PIANA A PINZA
CLIPS BASE



OPTIONAL 03
BASE PIANA A PINZA DOPPIA
DOUBLE FLAT CLIP BASE



OPTIONAL 04
BTF-KIT PIEDINI
BTF-KIT FEET



OPTIONAL 05
BTFA-KIT PIEDINI CON GANCI
BTFA-KIT FEET WITH HOOKS



OPTIONAL 06
PPTF-TAPPO PER FISSAGGIO PAVIMENTO
PPTF-CAP FOR FIXING TO THE FLOOR



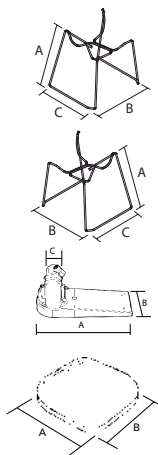
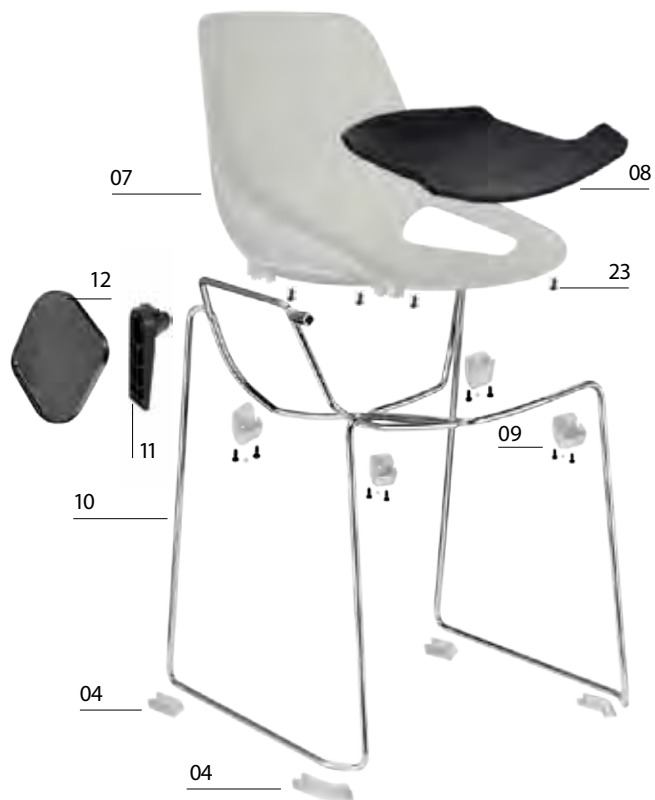

10 Q5-TELAIO SLITTA IN TONDINO PER SCOCCA CON PORTA TAVOLETTA DESTRO SENZA TAPPI									
Q5-SLIDE WIRE FRAME FOR SHELL WITH RIGHT TABLET HOOK WITHOUT CAPS									
CODICE/CODE	FINITURA/FINISHING	AGGANCI/O/HOOK	Q. KIT	Q. MIN/PACK	A	B	C	KG. x1/WT.x1	VOL. x1/UNIT VOL.
113410-013	■ CROMATO/CHROME	DESTRO/RIGHT	x1	50	450	550	510	4,50	mc. 0,057
22 Q5-TELAIO SLITTA IN TONDINO PER SCOCCA CON PORTA TAVOLETTA SINISTRO SENZA TAPPI									
Q5-SLIDE WIRE FRAME FOR SHELL WITH LEFT TABLET HOOK WITHOUT CAPS									
CODICE/CODE	FINITURA/FINISHING	AGGANCI/O/HOOK	Q. KIT	Q. MIN/PACK	A	B	C	KG. x1/WT.x1	VOL. x1/UNIT VOL.
113410-017	■ CROMATO/CHROME	SINISTRO/LEFT	x1	50	450	550	510	4,50	mc. 0,057
11 SPT2-SNODO PER TAVOLETTA IN TERMOPLASTICA									
SPT2-THERMOPLASTIC WRITING TABLET ARTICULATION									
CODICE/CODE	FINITURA/FINISHING	Q. KIT	Q. MIN/PACK	A	B	C	KG. x1/WT.x1	VOL. x1/UNIT VOL.	
134003-039	■ NERO/BLACK	x1	20	180	66	15x15	0,35	mc. 0,0006	
12 TLT2-TAVOLETTA IN TERMOPLASTICO OVALE SPESSORE 16 MM PER BRACCIOLO DESTRO E SINISTRO									
TLT2-WRITING TABLET IN OVAL PLASTIC THICKNESS 16 MM FOR LEFT AND RIGHT ARMS									
CODICE/CODE	FINITURA/FINISHING	Q. KIT	Q. MIN/PACK	A	B	KG. x1/WT.x1	VOL. x1/UNIT VOL.		
134003-040	■ NERO/BLACK	x1	20	271	271	0,40	mc. 0,002		

OPTIONAL 22

TELAIO SLITTA CON PORTA TAVOLETTA SINISTRO
SLIDE WIRE FRAME WITH LEFT TABLET HOOK



10

22

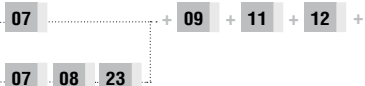

02
OPTIONAL
04
OPTIONAL
05
OPTIONAL

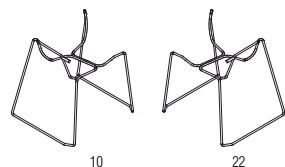

10

22



OPTIONAL

TAVOLETTA TLT
TLT TABLET



VEDI/SEE PAG. 327

TAVOLETTA TLT2
TLT2 TABLET



VEDI/SEE PAG. 327

TAVOLETTA TLT3
TLT3 TABLET



VEDI/SEE PAG. 327

TAVOLETTA BEAN
BEAN TABLET



VEDI/SEE PAG. 327

TAVOLETTA TL01
TL01 TABLET



VEDI/SEE PAG. 327

SNODO TAVOLETTA SPT2
SPT2 MECHANISM TABLET



VEDI/SEE PAG. 326

SNODO ANTIPANICO
MECHANISM ANTIPANIC



VEDI/SEE PAG. 326

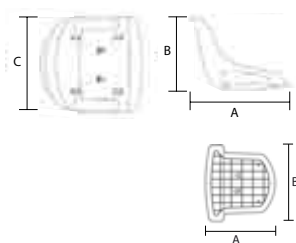
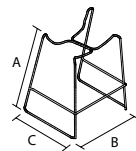
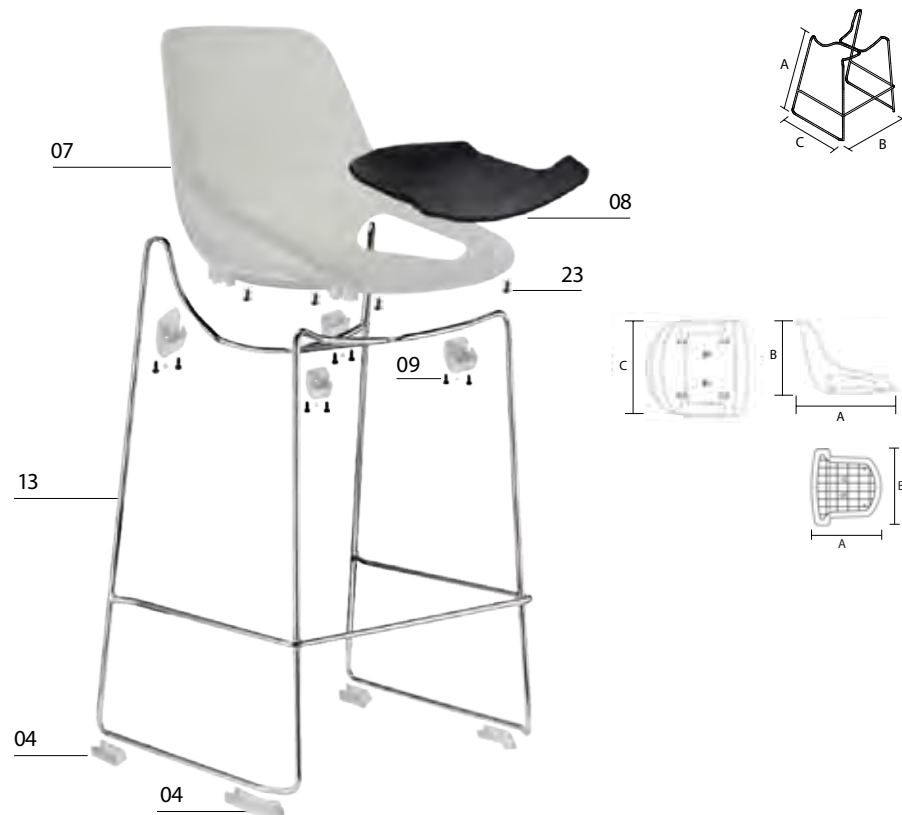

13	Q5-SGABELLO ALTO IN TONDINO PER SCOCCA SENZA TAPPI Q5-WIRED FRAME TALL STOOL FOR SHELL WITHOUT CAPS								
CODICE/CODE	FINITURA/FINISHING	Q. KIT	Q. MIN/PACK	A	B	C	KG. x1/WT.x1	VOL. x1/UNIT VOL.	
113410-006	■ CROMATO/CHROME	x1	50	700	550	510	6,30	mc. 0,08	
02	BASE PIANA A PINZA IN PE PER TONDO CLIPS BASE FOR TUBE								
CODICE/CODE	FINITURA/FINISHING	Q. KIT							
134006-020	□ NEUTRO/NEUTRAL	x4							
04	BTF-KIT PIEDINI BTF-KIT FEET								
CODICE/CODE	FINITURA/FINISHING	Q. KIT	Q. MIN/PACK						
134306-001	□ NEUTRO/NEUTRAL	x1	100						
07	Q5-SCOCCA INTERA MODELLO Q5 Q5-SHELL MODEL Q5								
CODICE/CODE	FINITURA/FINISHING	Q. KIT	Q. MIN/PACK	A	B	C	KG. x1/WT.x1	VOL. x1/UNIT VOL.	
133903-035	■ MARRONE/BROWN RAL8022	x1	10	400	400	470	1,60	mc. 0,02	
133905-035	□ AVORIO/IVORY RAL1013	x1	10	400	400	470	1,60	mc. 0,02	
133908-035	□ GIALLO/YELLOW RAL1012	x1	10	400	400	470	1,60	mc. 0,02	
133904-035	■ GRIGIO/GREY RAL7003	x1	10	400	400	470	1,60	mc. 0,02	
08	Q5-PANNELLO SEDILE DA TAPPEZZARE Q5-PANEL BACK FOR UPHOLSTERY								
CODICE/CODE	FINITURA/FINISHING	Q. KIT	Q. MIN/PACK	A	B		KG. x1/WT.x1	VOL. x1/UNIT VOL.	
132203-048	■ NERO/BLACK	x1	20	390	420		0,52	mc. 0,003	
09	Q5-CONFEZIONE ACCESSORI PER SCOCCA Q5 Q5-PACKAGING ACCESSORIES FOR SHELL Q5								
CODICE/CODE	FINITURA/FINISHING	Q. KIT	Q. MIN/PACK				KG. x1/WT.x1	VOL. x1/UNIT VOL.	
137003-004	■ MARRONE/BROWN RAL8022	x1	10			telaio in tondino/wire frame	0,085	mc. 0,00	
137005-004	□ AVORIO/IVORY RAL1013	x1	10			telaio in tondino/wire frame	0,085	mc. 0,00	
137008-004	□ GIALLO/YELLOW RAL1012	x1	10			telaio in tondino/wire frame	0,085	mc. 0,00	
137004-004	■ GRIGIO/GREY RAL7003	x1	10			telaio in tondino/wire frame	0,085	mc. 0,00	
23	VITE TBL +FR 5x14 PER PANNELLO DA TAPPEZZARE SCREW TBL +FR 5X14 FOR UPHOLSTERY PANEL								
CODICE/CODE	FINITURA/FINISHING	Q. KIT							
117803-156	■ NERO/BLACK	x4							

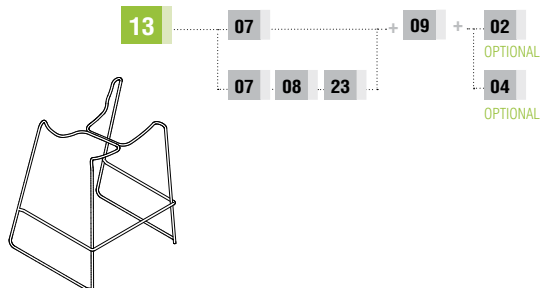

OPTIONAL 02
BASE PIANA A PINZA
CLIPS BASE



OPTIONAL 04
BTF-KIT PIEDINI
BTF-KIT FEET



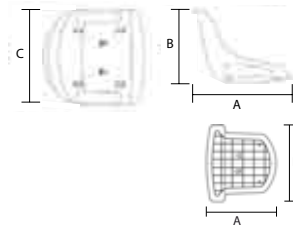
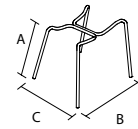
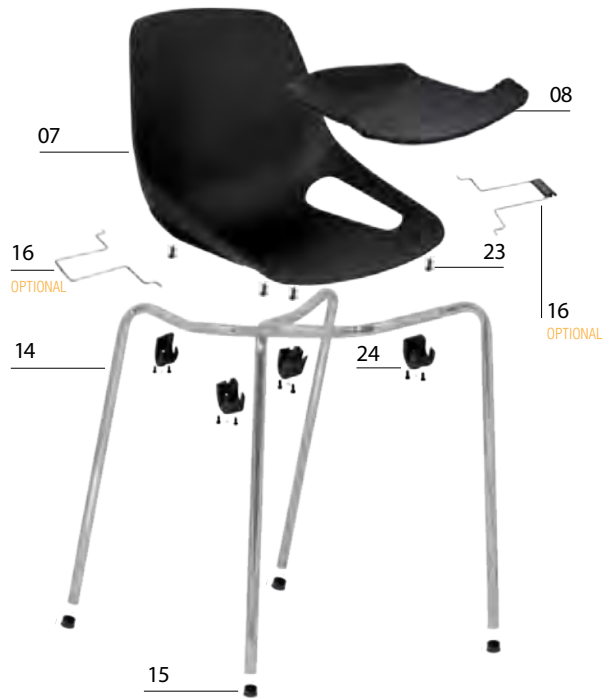

14	Q5-TELAIO 4 GAMBE IN TUBO D.18 SENZA TAPPI Q5-4 LEGS FRAMES D.18 WITHOUT CAPS							
CODICE/CODE	FINITURA/FINISHING	Q.KIT	Q.MIN/PACK	A	B	C	KG.x1/WT.x1	VOL.x1/UNIT VOL.
110603-022	■ NERO/BLACK	x1	200	450	460	480	1,70	mc. 0,02
110604-022	■ GRIGIO/GREY	x1	200	450	460	480	1,70	mc. 0,02
110610-135	■ CROMATO/CHROME	x1	200	450	460	480	1,70	mc. 0,02
15	PUNTALE ALETTATO TONDO D.18 NERO INNER CAP FOR LEGS D.18 BLACK							
CODICE/CODE	FINITURA/FINISHING	Q.KIT						
134203-180	■ NERO/BLACK	x4						
07	Q5-SCocca INTERNA MODELLO Q5 Q5-SHELL MODEL Q5							
CODICE/CODE	FINITURA/FINISHING	Q.KIT	Q.MIN/PACK	A	B	C	KG.x1/WT.x1	VOL.x1/UNIT VOL.
133903-035	■ MARRONE/BROWN RAL8022	x1	10	400	400	470	1,60	mc. 0,02
133905-035	□ AVORIO/IVORY RAL1013	x1	10	400	400	470	1,60	mc. 0,02
133908-035	□ GIALLO/YELLOW RAL1012	x1	10	400	400	470	1,60	mc. 0,02
133904-035	■ GRIGIO/GREY RAL7003	x1	10	400	400	470	1,60	mc. 0,02
08	Q5-PANNELLO SEDILE DA TAPPEZZARE Q5-PANEL BACK FOR UPHOLSTERY							
CODICE/CODE	FINITURA/FINISHING	Q.KIT	Q.MIN/PACK	A	B			
132203-048	■ NERO/BLACK	x1	20	390	420			
24	Q5-CONFEZIONE ACCESSORI PER SCocca Q5 Q5-PACKAGING ACCESSORIES FOR SHELL Q5							
CODICE/CODE	FINITURA/FINISHING	Q.KIT	Q.MIN/PACK					
137003-003	■ MARRONE/BROWN RAL8022	x1	10	telaio tubo/tube frame 0,085 mc. 0,00				
137005-003	□ AVORIO/IVORY RAL1013	x1	10	telaio tubo/tube frame 0,085 mc. 0,00				
137008-003	□ GIALLO/YELLOW RAL1012	x1	10	telaio tubo/tube frame 0,085 mc. 0,00				
137004-003	■ GRIGIO/GREY RAL7003	x1	10	telaio tubo/tube frame 0,085 mc. 0,00				
23	VITE TBL +FR 5x14 PER PANNELLO DA TAPPEZZARE SCREW TBL +FR 5X14 FOR UPHOLSTERY PANEL							
CODICE/CODE	FINITURA/FINISHING	Q.KIT						
117803-156	■ NERO/BLACK	x4						
16	Q5-COPPIA AGGANCIo LATERALE IN TONDINO + PLASTICA NERA Q5-COUPLE ROUND BAR LATERAL HOOK + BLACK PLASTIC							
CODICE/CODE	FINITURA/FINISHING	Q.KIT	Q.MIN/PACK	KG.x1/WT.x1	VOL.x1/UNIT VOL.			
113410-004	■ CROMATO/CHROME	x1	50	0,15	mc. 0,004			

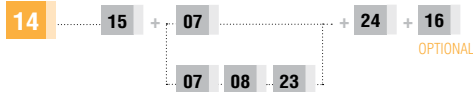

OPTIONAL 16

COPPIA AGGANCIo LATERALE
COUPLE LATERAL HOOK



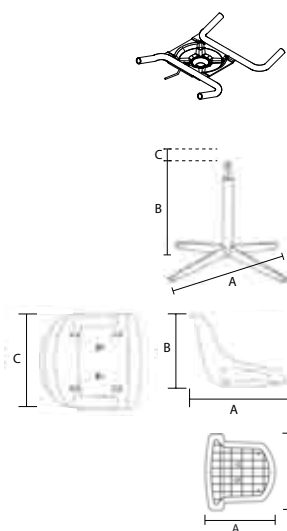
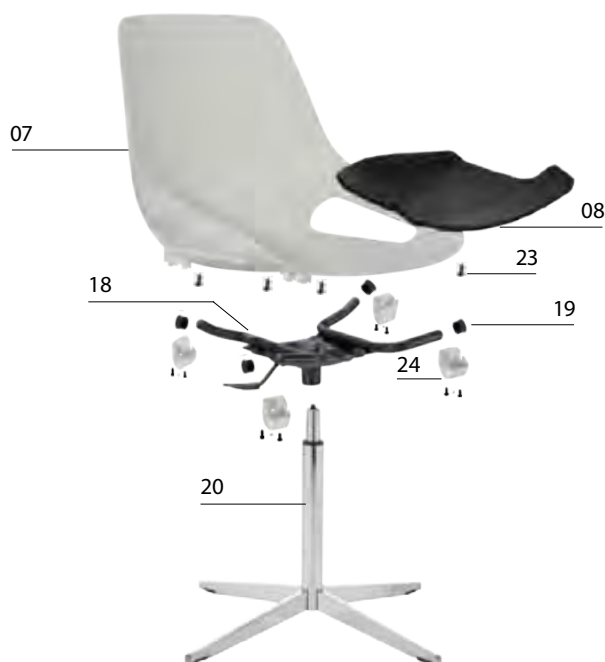

18	Q5-SUPPORTO GIREVOLE A GAS PER SCOCCA Q5 Q5-GAS LIFT SWIVEL WIRE FRAME FOR SHELL WITHOUT CAPS								
CODICE/CODE	FINITURA/FINISHING	Q. KIT	Q. MIN/PACK			KG. x1/WT.x1	VOL. x1/UNIT VOL.		
110903-012	■ NERO/BLACK	x1	10			1,40	mc. 0,004		
110904-012	■ GRIGIO/GREY	x1	10			1,40	mc. 0,004		
19	TAPPO COPRITESTA ALETTATO TONDO D.18 NERO INNER CAPS-COVER HEAD D.18 BLACK								
CODICE/CODE	FINITURA/FINISHING	Q. KIT							
134103-180	■ NERO/BLACK	x4							
20	B20-BASE CON POMPA A GAS ASSEMBLATA B20-BASE WITH GAS PUMP ASSEMBLED								
CODICE/CODE	FINITURA/FINISHING	Q. KIT	Q. MIN/PACK	A	B	C	KG. x1/WT.x1	VOL. x1/UNIT VOL.	
110210-080	■ CROMATO/CHROME	x1	100	700	325	75	4,80	mc. 0,02	
07	Q5-SCOCCA INTERA MODELLO Q5 Q5-SHELL MODEL Q5								
CODICE/CODE	FINITURA/FINISHING	Q. KIT	Q. MIN/PACK	A	B	C	KG. x1/WT.x1	VOL. x1/UNIT VOL.	
133903-035	■ MARRONE/BROWN RAL8022	x1	10	400	400	470	1,60	mc. 0,02	
133905-035	□ AVORIO/IVORY RAL1013	x1	10	400	400	470	1,60	mc. 0,02	
133908-035	□ GIALLO/YELLOW RAL1012	x1	10	400	400	470	1,60	mc. 0,02	
133904-035	■ GRIGIO/GREY RAL7003	x1	10	400	400	470	1,60	mc. 0,02	
08	Q5-PANNELLO SEDILE DA TAPPEZZARE Q5-PANEL BACK FOR UPHOLSTERY								
CODICE/CODE	FINITURA/FINISHING	Q. KIT	Q. MIN/PACK	A	B		KG. x1/WT.x1	VOL. x1/UNIT VOL.	
132203-048	■ NERO/BLACK	x1	20	390	420		0,52	mc. 0,003	
24	Q5-CONFEZIONE ACCESSORI PER SCOCCA Q5 Q5-PACKAGING ACCESSORIES FOR SHELL Q5								
CODICE/CODE	FINITURA/FINISHING	Q. KIT	Q. MIN/PACK				KG. x1/WT.x1	VOL. x1/UNIT VOL.	
137003-003	■ MARRONE/BROWN RAL8022	x1	10	telaio tubo/tube frame			0,085	mc. 0,00	
137005-003	□ AVORIO/IVORY RAL1013	x1	10	telaio tubo/tube frame			0,085	mc. 0,00	
137008-003	□ GIALLO/YELLOW RAL1012	x1	10	telaio tubo/tube frame			0,085	mc. 0,00	
137004-003	■ GRIGIO/GREY RAL7003	x1	10	telaio tubo/tube frame			0,085	mc. 0,00	
23	VITE TBL +FR 5x14 PER PANNELLO DA TAPPEZZARE SCREW TBL +FR 5X14 FOR UPHOLSTERY PANEL								
CODICE/CODE	FINITURA/FINISHING	Q. KIT							
117803-156	■ NERO/BLACK	x4							

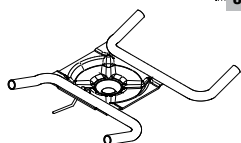
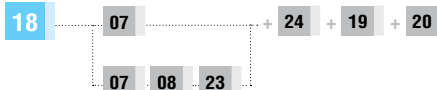



PER I COMPONENTI DELLA PANCA VAI A PAG. 337
FOR THE BENCH COMPONENTS GO TO PAGE 337

21	Q5-SUPPORTO PER ATTACCO SCOCCA Q5 SU PANCA		Q. KIT x1	Q. MIN/PACK 10	KG. x1/WT.x1 1,40	VOL. x1/UNIT VOL. mc. 0,004
	Q5-BENCH FRAME FOR Q5 SHELL					
	CODICE/CODE 110703-188	FINITURA/FINISHING ■ NERO/BLACK				

OPTIONAL GAMBA
LEG OPTIONAL



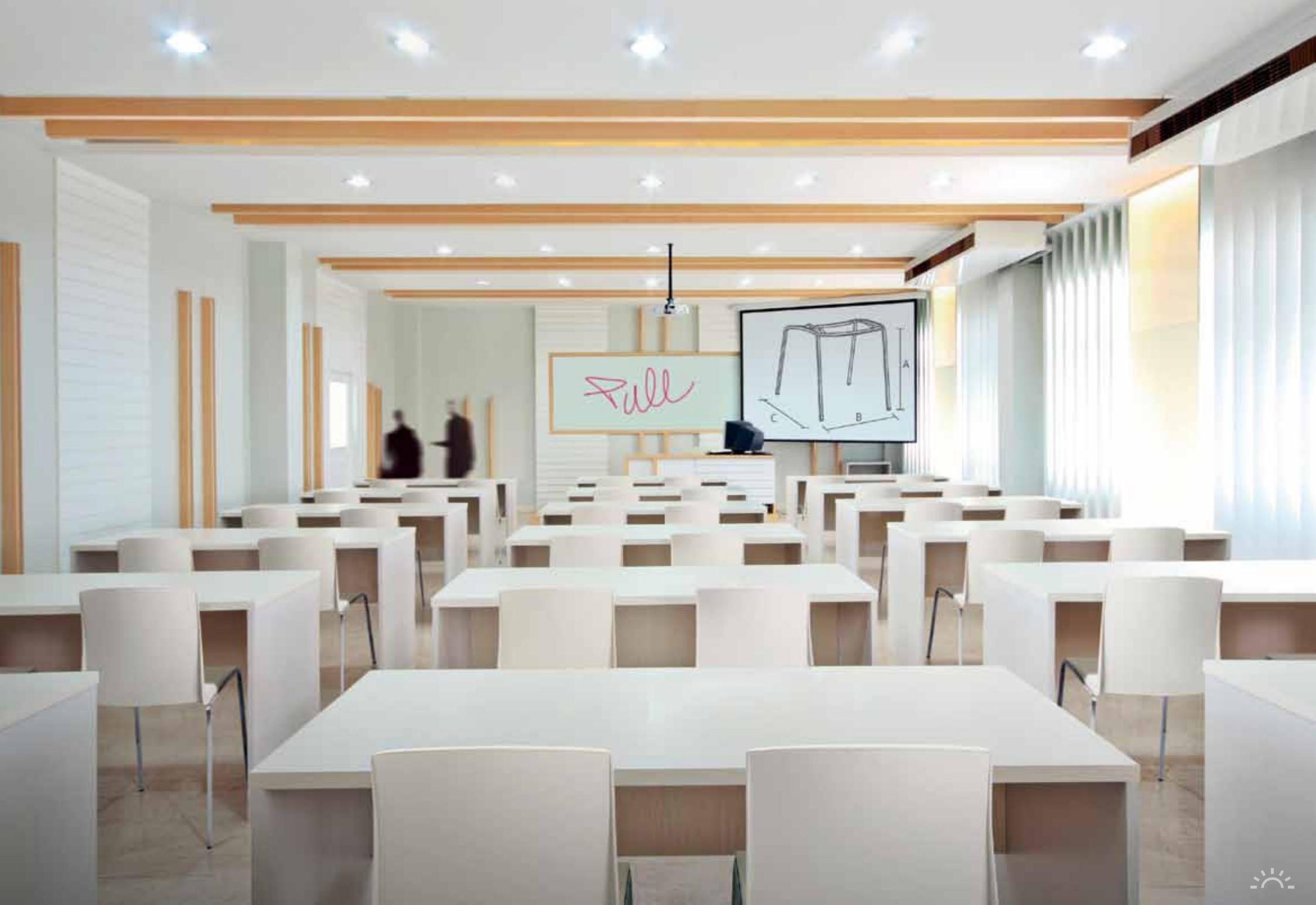



SLIDE



4 LEGS



SWIVEL

BENCH



PULL 4 LEGS

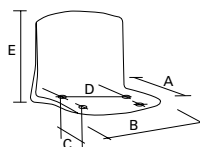
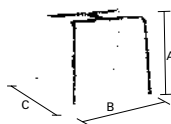

34
PULL

05 PULL-SGABELLO IN TUBO D.18 PER SCOCCA PULL-STOOL TUBE D.18 FOR SHELL									
CODICE/CODE	FINITURA/FINISHING	Q. KIT	Q. MIN/PACK	A	B	C	KG. x1/WT.x1	VOL. x1/UNIT VOL.	
110603-075	■ NERO/BLACK	x1	200	450	470	490	2,00	mc. 0,02	
110604-095	■ GRIGIO/GREY	x1	200	450	470	490	2,00	mc. 0,02	
110610-045	■ CROMATO/CHROME	x1	200	450	470	490	2,00	mc. 0,02	

06 TAPPO SOTTOPIEDE D.18 NERO INNER CAP FOR LEG D.18 BLACK									
CODICE/CODE	FINITURA/FINISHING	Q. KIT							
134203-180	■ NERO/BLACK	x4							

07 VITE HILO 5,5X30 TESTA SVASATA A CROCE ZINCATA (VITE PER FISSAGGIO SCOCCA) CROSS SCREW HILO D.5X30 FLARED ZINC (SCREW FOR SHELL FIXING)									
CODICE/CODE	FINITURA/FINISHING	Q. KIT							
117811-166	■ ZINCATA/ZINC	x4							

10 PULL-SCOCCA INTERA MODELLO PULL PULL-SHELL MOD. PULL										
CODICE/CODE	FINITURA/FINISHING	Q. KIT	Q. MIN/PACK	A	B	C	D	E	KG. x1/WT.x1	VOL. x1/UNIT VOL.
133904-026	■ GRIGIO/GREY RAL 7035	x1	10	520	450	255	315	393	1,60	mc. 0,021
133903-025	■ NERO/BLACK	x1	10	520	450	255	315	393	1,60	mc. 0,021
133907-025	■ ARANCIO/ORANGE RAL 2003	x1	10	520	450	255	315	393	1,60	mc. 0,021
133905-026	□ BIANCO/WHITE 218	x1	10	520	450	255	315	393	1,60	mc. 0,021
133902-026	■ ROSSO/RED 527	x1	10	520	450	255	315	393	1,60	mc. 0,021

08 SUPPORTO PER IMPILABILITA' SCOCCA NEUTRO SUPPORT FOR SHELL STACKABILITY NEUTRAL									
CODICE/CODE	FINITURA/FINISHING	Q. KIT							
134006-030	□ NEUTRO/NEUTRAL	x1							

09 VITE HILO TB 5X14 NERA HILO CROSS SCREW TB 5X14 BLACK									
CODICE/CODE	FINITURA/FINISHING	Q. KIT							
117803-155	■ NERO/BLACK	x1							

OPTIONAL 08/09

SUPPORTO PER IMPILABILITA' SCOCCA + VITE
SUPPORT FOR SHELL STACKABILITY AND SCREW

05 + 10 + 06 + 07 + 08 + 09

OPTIONAL OPTIONAL



4 LEGS OPTIONS:

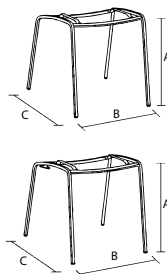
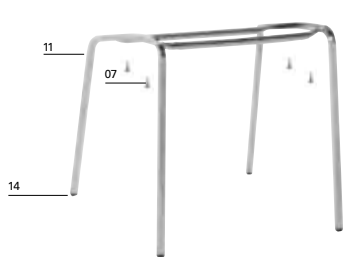

11

10 + 14 + 07

12

OPTIONAL

OPTIONAL 12

SGABELLO MOD. EOS IN TUBO QUADRO 15X15 CON AGGANCIAMENTO LATERALE
STOOL MOD.EOS TUBE SQUARE 15X15 WITH LATERAL HOOK

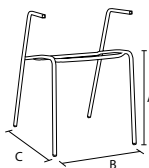
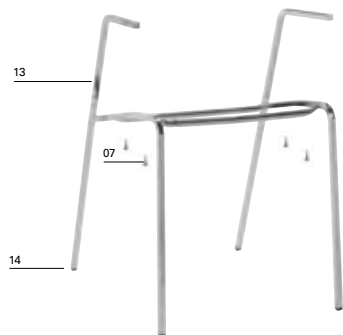
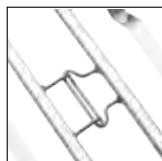

13

10 + 14 + 07

11 SGABELLO MOD. EOS IN TUBO QUADRO 15X15 PER SCOCCA MODELLO PULL

STOOL MOD. EOS TUBE SQUARE 15X15 FOR SHELL MOD. PULL

CODICE/CODE	FINITURA/FINISHING	Q. KIT	Q. MIN/PACK	A	B	C	KG.x1/WT.x1	VOL.x1/UNIT VOL.
110603-077	■ NERO/BLACK	x1	100	470	450	600	2,45	mc. 0,03
110604-097	■ GRIGIO/GREY	x1	100	470	450	600	2,45	mc. 0,03
110610-047	■ CROMATO/CHROME	x1	100	470	450	600	2,45	mc. 0,03

12 SGABELLO MOD. EOS IN TUBO QUADRO 15X15 CON AGGANCIAMENTO LATERALE PER SCOCCA MODELLO PULL

STOOL MOD.EOS TUBE SQUARE 15X15 WITH LATERAL HOOK FOR SHELL MOD.PULL

CODICE/CODE	FINITURA/FINISHING	Q. KIT	Q. MIN/PACK	A	B	C	KG.x1/WT.x1	VOL.x1/UNIT VOL.
110603-078	■ NERO/BLACK	x1	100	470	450	600	2,55	mc. 0,03
110604-098	■ GRIGIO/GREY	x1	100	470	450	600	2,55	mc. 0,03
110610-048	■ CROMATO/CHROME	x1	100	470	450	600	2,55	mc. 0,03

14 TAPPO SOTTOPIEDE QUADRO 15X15 NERO TESTA TONDA

SQUARE INSERT IN PE 15X15 BLACK ROUND HEAD

CODICE/CODE	FINITURA/FINISHING	Q. KIT
134203-152	■ NERO/BLACK	x4

+ 07 VITE / SCREW

13 SGABELLO MOD. EOS IN TUBO QUADRO 15X15 CON BRACCIOLI PER SCOCCA MODELLO PULL

STOOL MOD.EOS TUBE SQUARE 15X15 WITH ARMS FOR SHELL MOD.PULL

CODICE/CODE	FINITURA/FINISHING	Q. KIT	Q. MIN/PACK	A	B	C	KG.x1/WT.x1	VOL.x1/UNIT VOL.
110603-076	■ NERO/BLACK	x1	60	470	450	600	3,00	mc. 0,05
110604-096	■ GRIGIO/GREY	x1	60	470	450	600	3,00	mc. 0,05
110610-046	■ CROMATO/CHROME	x1	60	470	450	600	3,00	mc. 0,05

14 TAPPO SOTTOPIEDE QUADRO 15X15 NERO TESTA TONDA

SQUARE INSERT IN PE 15X15 BLACK ROUND HEAD

CODICE/CODE	FINITURA/FINISHING	Q. KIT
134203-152	■ NERO/BLACK	x4

+ 07 VITE / SCREW

PULL-CARRELLO PORTASEDIE CON ACCESSORI CROMATO

PULL-TROLLEY FOR CHAIRS WITH ACCESSORIES CHROME

CODICE/CODE	FINITURA/FINISHING
110810-009	■ CROMATO/CHROME



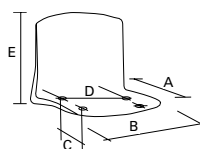
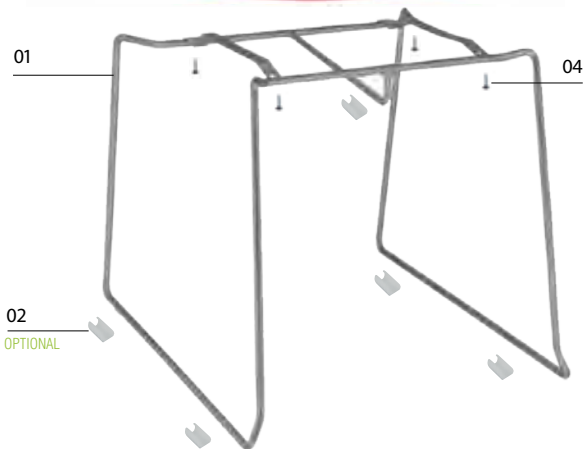
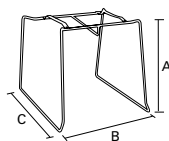

01 SPEEDY-SGABELLO IN TONDINO PER SCOCCA MODELLO PULL

SPEEDY-ROUND BAR FOR THE SHELL MOD.PULL

CODICE/CODE	FINITURA/FINISHING	Q. KIT	Q. MIN/PACK	A	B	C	KG.x1/WT.x1	VOL.x1/UNIT VOL.
113410-025	■ CROMATO/CHROME	x1	120	450	580	570	3,05	mc. 0,04

02 BASE PIANA A PINZA IN PE PER TONDO

CLIPS BASE FOR TUBE

CODICE/CODE	FINITURA/FINISHING	Q. KIT
134006-020	□ NEUTRO/NEUTRAL	x5

03 BASE PIANA A PINZA DOPPIA IN PE PER TONDO PER UNIONE SEDIE

DOUBLE FLAT CLIP BASE FOR TUBE

CODICE/CODE	FINITURA/FINISHING	Q. KIT
134006-021	□ NEUTRO/NEUTRAL	x4

10 PULL-SCOCCA INTERA MODELLO PULL

PULL-SHELL MOD. PULL

CODICE/CODE	FINITURA/FINISHING	Q. KIT	Q. MIN/PACK	A	B	C	D	E	KG.x1/WT.x1	VOL.x1/UNIT VOL.
133904-026	■ GRIGIO/GREY RAL 7035	x1	10	520	450	255	315	393	1,60	mc. 0,021
133903-025	■ NERO/BLACK	x1	10	520	450	255	315	393	1,60	mc. 0,021
133907-025	■ ARANCIO/ORANGE RAL 2003	x1	10	520	450	255	315	393	1,60	mc. 0,021
133905-026	□ BIANCO/WHITE 218	x1	10	520	450	255	315	393	1,60	mc. 0,021
133902-026	■ ROSSO/RED 527	x1	10	520	450	255	315	393	1,60	mc. 0,021

04 VITE TC+COMBI 6X16 TESTA CILINDRICA A CROCE ZINCATA (VITE FISSAGGIO SCOCCA)

SCREW COMBI 6X16 CYLINDRICAL HEAD CROSS ZINC (SCREW FOR FIX SHELL)

CODICE/CODE	FINITURA/FINISHING	Q. KIT
117811-181	■ ZINCATA/ZINC	x4

OPTIONAL 02

BASE PIANA A PINZA
CLIPS BASE



OPTIONAL 03

BASE PIANA A PINZA DOPPIA
DOUBLE FLAT CLIP BASE

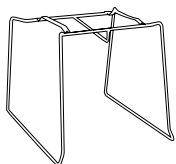
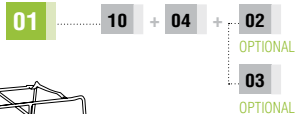

PULL SWIVEL

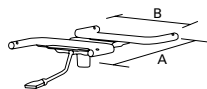

15	SUPPORTO GIREVOLE A GAS PER SCOCCA PULL		Q. KIT	Q. MIN/PACK	A	B	KG. x1/WT.x1	VOL. x1/UNIT. VOL.
	SWIVEL METAL FRAME FOR GAS LIFT FOR PULL SHELL							
	CODICE/CODE	FINITURA/FINISHING						
	110903-025	■ NERO/BLACK	x1	10	315	255	1,40	mc. 0,004

17	TAPPI COPRITESTA ALETTATO D.18 NERO		Q. KIT
	COVER HEAD D.18 BLACK		
	CODICE/CODE	FINITURA/FINISHING	
	134103-180	■ NERO/BLACK	x4

18	VITE HILO 5,5X30 TESTA SVASATA A CROCE ZINCATA (VITE PER FISSAGGIO SCOCCA)		Q. KIT
	CROSS SCREW HILO 5.5X30 FLARED ZINC (SCREW FOR FIXING SHELL)		
	CODICE/CODE	FINITURA/FINISHING	
	117811-166	□ ZINCATA/ZINC	x4

15 **10** + **17** + **18**





PER I COMPONENTI DELLA PANCA VAI A PAG. 337
FOR THE BENCH COMPONENTS GO TO PAGE 337

16 SUPPORTO PER ATTACCO SCOCCA PULL SU PANCA
BENCH FRAME FOR PULL SHELL

CODICE/CODE	FINITURA/FINISHING	Q. KIT	Q. MIN/PACK	A	B	KG. x1/WT.x1	VOL. x1/UNIT VOL.
110703-085	■ NERO/BLACK	x1	10	315	255	1,40	mc. 0,004

17 TAPPI COPRITESTA ALETTATO D.18 NERO
COVER HEAD D.18 BLACK

CODICE/CODE	FINITURA/FINISHING	Q. KIT
134103-180	■ NERO/BLACK	x4

18 VITE HILO 5,5X30 TESTA SVASATA A CROCE ZINCATA (VITE PER FISSAGGIO SCOCCA)
CROSS SCREW HILO 5.5X30 FLARED ZINC (SCREW FOR FIXING SHELL)

CODICE/CODE	FINITURA/FINISHING	Q. KIT
117811-166	▣ ZINCATA/ZINC	x4

10 PULL-SCOCCA INTERA MODELLO PULL
PULL-SHELL MOD. PULL

CODICE/CODE	FINITURA/FINISHING	Q. KIT	Q. MIN/PACK	A	B	C	D	E	KG. x1/WT.x1	VOL. x1/UNIT VOL.
133904-026	■ GRIGIO/GREY RAL 7035	x1	10	520	450	255	315	393	1,60	mc. 0,021
133903-025	■ NERO/BLACK	x1	10	520	450	255	315	393	1,60	mc. 0,021
133907-025	■ ARANCIO/ORANGE RAL 2003	x1	10	520	450	255	315	393	1,60	mc. 0,021
133905-026	□ BIANCO/WHITE 218	x1	10	520	450	255	315	393	1,60	mc. 0,021
133902-026	■ ROSSO/RED 527	x1	10	520	450	255	315	393	1,60	mc. 0,021

16 10 + 17 + 18



OPTIONAL GAMBA
LEG OPTIONAL









SLIDE



4 LEGS



SWIVEL

SMILE



BENCH

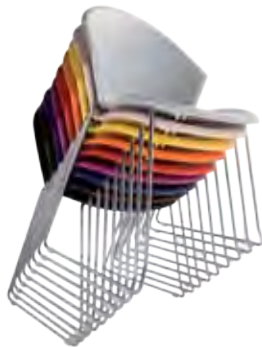

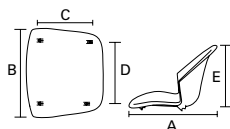
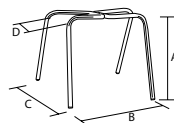

01 SMILE-SGABELLO 4 GAMBE IN TUBO D.20 SENZA TAPPI
SMILE-4 LEGS STOOL D.20 WITHOUT CAPS

CODICE/CODE	FINITURA/FINISHING	Q. KIT	Q. MIN/PACK	A	B	C	D	KG.x1/WT.x1	VOL.x1/UNIT VOL.
112703-030	■ NERO/BLACK	x1	150	430	440	540	260	1,80	mc. 0,02
112704-030	■ GRIGIO/GREY	x1	150	430	440	540	260	1,80	mc. 0,02
112710-030	■ CROMATO/CHROME	x1	150	430	440	540	260	1,80	mc. 0,02

02 TAPPI-PUNTALE ALETTATO D.20 NERO
INNER CAPS-BLACK ROUND INSERT CAP D.20

CODICE/CODE	FINITURA/FINISHING	Q. KIT
134203-200	■ NERO/BLACK	x4

03 SMILE-SCOCCA INTERA MODELLO SMILE
SMILE-SHELL MODEL SMILE

CODICE/CODE	FINITURA/FINISHING	Q. KIT	Q. MIN/PACK	A	B	C	D	E	KG.x1/WT.x1	VOL.x1/UNIT VOL.
133903-053	■ NERO/BLACK	x1	10	540	510	235	277	395	1,50	mc. 0,015
133905-053	□ BIANCO/WHITE 218	x1	10	540	510	235	277	395	1,50	mc. 0,015
133915-053	■ BLU/BLUE 5002	x1	10	540	510	235	277	395	1,50	mc. 0,015

04 VITI-VITE HILO D.5X35 TESTA SVASATA A CROCE ZINCATA (VITE FISSAGGIO SCOCCA)
SCREWS-CROSS SCREW HILO D.5X35 FLARED ZINC (SCREW FOR FIXING SHELL)

CODICE/CODE	FINITURA/FINISHING	Q. KIT
117811-153	■ ZINCATA/ZINC	x4

01 03 + 04 + 02



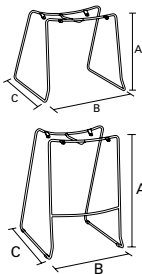
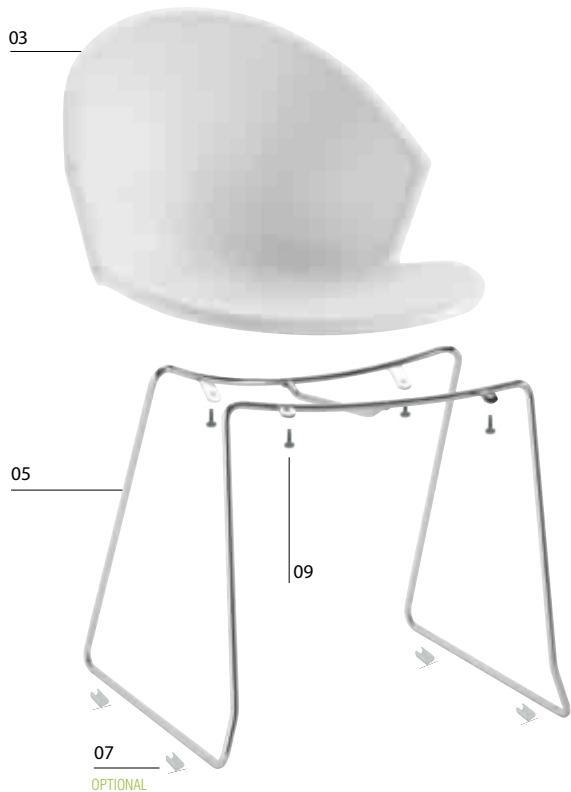

05	SMILE-SGABELLO IN TONDINO CROMATO PER SCOCCA SENZA TAPPI SMILE-CHROME WIRED FRAME STOOL FOR SHELL WITHOUT CAPS								
	CODICE/CODE 113410-018	FINITURA/FINISHING ■ CROMATO/CHROME	Q. KIT x1	Q. MIN/PACK 100	A 450	B 500	C 500	KG.x1/WT.x1 3,20	VOL.x1/UNIT.VOL. mc. 0,04
06	SMILE-SGABELLO ALTO IN TONDINO CROMATO PER SCOCCA SENZA TAPPI SMILE-CHROME WIRED FRAME TALL STOOL FOR SHELL WITHOUT CAPS								
	CODICE/CODE 113410-019	FINITURA/FINISHING ■ CROMATO/CHROME	Q. KIT x1	Q. MIN/PACK 50	A 700	B 500	C 560	KG.x1/WT.x1 5,00	VOL.x1/UNIT.VOL. mc. 0,08
07	BASE PIANA A PINZA IN PE PER TONDO CLIPS BASE FOR WIRE								
	CODICE/CODE 134006-020	FINITURA/FINISHING □ NEUTRO/NEUTRAL	Q. KIT x4						
08	BASE PIANA A PINZA DOPPIA IN PE PER TONDO DOUBLE FLAT CLIP BASE FOR WIRE								
	CODICE/CODE 134006-021	FINITURA/FINISHING □ NEUTRO/NEUTRAL	Q. KIT x4						
09	VITE AUTOFILETTANTE 5,5X19 TESTA CILINDRICA A CROCE ZINCATA (VITE FISSAGGIO SCOCCA) AUTO-THREAD SCREW 5,5X19 CYLINDRICAL HEAD CROSS ZINC (SCREW FOR SHELL FIXING)								
	CODICE/CODE 117811-180	FINITURA/FINISHING ■ ZINCATA/ZINC	Q. KIT x4						

OPTIONAL 07

BASE PIANA A PINZA
CLIPS BASE



OPTIONAL 08

BASE PIANA A PINZA DOPPIA
DOUBLE FLAT CLIP BASE



OPTIONAL 06

SGABELLO ALTO IN TONDINO CROMATO
CHROME WIRED FRAME TALL STOOL

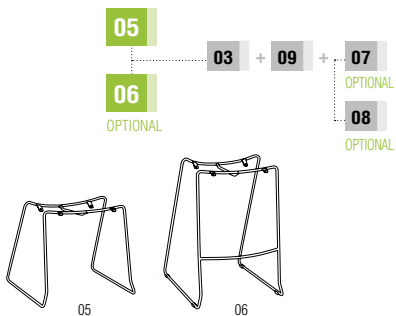

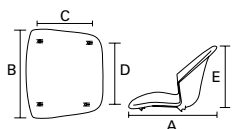
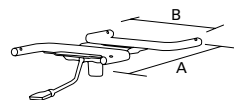

10 SMILE-SUPPORTO GIREVOLE A GAS PER SCOCCA SMILE
SMILE-GAS LIFT SWIVEL METAL FRAME FOR SMILE SHELL

CODICE/CODE	FINITURA/FINISHING	Q. KIT	Q. MIN/PACK	A	B	KG. x1/WT. x1	VOL. x1/UNIT. VOL.
110903-030	■ NERO/BLACK	x1	10	277	235	1,40	mc. 0,004
110904-008	■ GRIGIO/GREY	x1	10	277	235	1,40	mc. 0,004

12 TAPPI-TAPPO COPRITESTA ALETTATO D.20 NERO
INNER CAPS-COVER HEAD D.20 BLACK

CODICE/CODE	FINITURA/FINISHING	Q. KIT
134103-200	■ NERO/BLACK	x4

03 SMILE-SCOCCA INTERNA MODELLO SMILE
SMILE-SHELL MODEL SMILE

CODICE/CODE	FINITURA/FINISHING	Q. KIT	Q. MIN/PACK	A	B	C	D	E	KG. x1/WT. x1	VOL. x1/UNIT. VOL.
133903-053	■ NERO/BLACK	x1	10	540	510	235	277	395	1,50	mc. 0,015
133905-053	□ BIANCO/WHITE 218	x1	10	540	510	235	277	395	1,50	mc. 0,015
133915-053	■ BLU/BLUE 5002	x1	10	540	510	235	277	395	1,50	mc. 0,015

04 VITI-VITE HILO D.5X35 TESTA SVASATA A CROCE ZINCATA (VITE FISSAGGIO SCOCCA)
SCREWS-CROSS SCREW HILO D.5X35 FLARED ZINC (SCREW FOR FIXING SHELL)

CODICE/CODE	FINITURA/FINISHING	Q. KIT
117811-153	■ ZINCATA/ZINC	x4

10 03 + 04 + 12

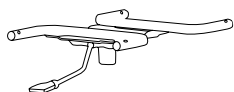



11	SMILE-SUPPORTO PER ATTACCO SCOCCA SMILE SU PANCA		Q. KIT	Q. MIN/PACK	A	B	KG.x1/WT.x1	VOL.x1/UNIT.VOL.
	SMILE-BENCH FRAME FOR OKI SHELL							
CODICE/CODE	FINITURA/FINISHING							
110703-087	■ NERO/BLACK		x1	10	277	235	1,40	mc. 0,004

PER I COMPONENTI DELLA PANCA VAI A PAG. 337
FOR THE BENCH COMPONENTS GO TO PAGE 337

11 **03** + **04** + **12**



OPTIONAL GAMBA
LEG OPTIONAL







OKI



SLIDE

4 LEGS

SWIVEL

BENCH





48
OKI

01 OKI-SGABELLO 4 GAMBE IN TUBO D.18 SENZA TAPPI

OKI-4 LEGS STOOL D.18 TUBE WITHOUT CAPS		Q. KIT	Q. MIN/PACK	A	B	KG. x1/WT.x1	VOL. x1/UNIT VOL.
112703-090	■ NERO/BLACK	x1	100	560	520	2,70	mc. 0,02
112704-090	■ GRIGIO/GREY	x1	100	560	520	2,70	mc. 0,02
112710-090	■ CROMATO/CHROME	x1	150	560	520	2,70	mc. 0,02

02 OKI-SGABELLO 4 GAMBE IN TUBO D.18 CON AGGANCIO LATERALE SENZA TAPPI

OKI-4 LEGS STOOL D.18 TUBE WITH LATERAL HOOKS WITHOUT CAPS		Q. KIT	Q. MIN/PACK	A	B	KG. x1/WT.x1	VOL. x1/UNIT VOL.
112703-091	■ NERO/BLACK	x1	100	560	520	2,70	mc. 0,02
112704-091	■ GRIGIO/GREY	x1	100	560	520	2,70	mc. 0,02
112710-091	■ CROMATO/CHROME	x1	150	560	520	2,70	mc. 0,02

05 TAPPI-PUNTALE ALETTATO TESTA SFERICA D.18 NERO

INNER CAPS-BLACK SPHERICAL CAP D.18		Q. KIT
134203-181	■ NERO/BLACK	x4

06 SUPPORTO PER IMPILABILITA' SCOCCA OKI NEUTRO

SUPPORT FOR STACKABILITY NEUTRAL SHELL OKI		Q. KIT
134006-031	□ NEUTRO/NEUTRAL	x1

10 OKI-SCOCCA INTERA MODELLO OKI

OKI-SHELL FOR OKI MODEL		Q. KIT	Q. MIN/PACK	A	B	C	D	E	KG. x1/WT.x1	VOL. x1/UNIT VOL.
133903-050	■ NERO/BLACK	x1	10	525	530	209	306	395	1,80	mc. 0,025
133905-050	□ BIANCO/WHITE 218	x1	10	525	530	209	306	395	1,80	mc. 0,025
133915-050	■ BLU/BLUE 5002	x1	10	525	530	209	306	395	1,80	mc. 0,025

12 VITE HILO D. 5X35 TESTA SVASATA A CROCE ZINCATA (VITE FISSAGGIO SCOCCA)

CROSS SCREW HILO D.5X35 FLARED ZINC (SCREW FOR SHELL FIXING)		Q. KIT
117811-153	□ ZINCATA/ZINC	x4

OPTIONAL 02

SGABELLO 4 GAMBE IN TUBO D.18 CON AGGANCIO LATERALE

4 LEGS STOOL D.18 TUBE WITH LATERAL HOOKS

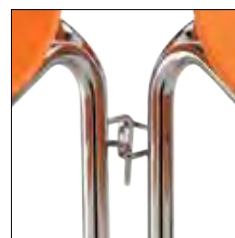

02
OPTIONAL



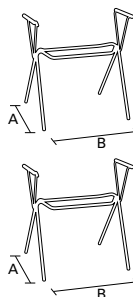

03 OKI-SGABELLO 4 GAMBE IN TUBO D.18 CON BRACCIOLI SENZA TAPPI
OKI-4 LEGS STOOL WITH ARMREST D.18 TUBE WITHOUT CAPS

CODICE/CODE	FINITURA/FINISHING	Q. KIT	Q. MIN./PACK	A	B	KG. x1/WT.x1	VOL. x1/UNIT VOL.
112703-096	■ NERO/BLACK	x1	50	560	520	4,00	mc. 0,05
112704-096	■ GRIGIO/GREY	x1	50	560	520	4,00	mc. 0,05
112710-096	■ CROMATO/CHROME	x1	50	560	520	4,00	mc. 0,05

04 OKI-SGABELLO 4 GAMBE TUBO D.18 CON BRACCIOLI + AGGANCIO PORTATAVOLETTA SENZA TAPPI
OKI-4 LEGS STOOL WITH ARMREST D.18 TUBE WITHOUT CAPS + HOOK FOR TABLET

CODICE/CODE	FINITURA/FINISHING	Q. KIT	Q. MIN./PACK	A	B	KG. x1/WT.x1	VOL. x1/UNIT VOL.
112703-098	■ NERO/BLACK	x1	50	560	520	4,00	mc. 0,05
112704-098	■ GRIGIO/GREY	x1	50	560	520	4,00	mc. 0,05
112710-098	■ CROMATO/CHROME	x1	50	560	520	4,00	mc. 0,05

OPTIONAL 04

SGABELLO 4 GAMBE TUBO D.18 CON BRACCIOLI + AGGANCIO PORTATAVOLETTA
4 LEGS STOOL WITH ARMREST D.18 TUBE + HOOK FOR TABLET



03 + **05** + **06** + **10** + **12**

04
OPTIONAL

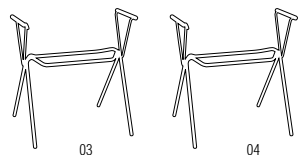

OPTIONAL

TAVOLETTA TLT
TLT TABLET



VEDI/SEE PAG. 327

TAVOLETTA TLT2
TLT2 TABLET



VEDI/SEE PAG. 327

TAVOLETTA TLT3
TLT3 TABLET



VEDI/SEE PAG. 327

TAVOLETTA BEAN
BEAN TABLET



VEDI/SEE PAG. 327

TAVOLETTA TL01
TL01 TABLET



VEDI/SEE PAG. 327

SNODO TAVOLETTA SPT2
SPT2 MECHANISM TABLET



VEDI/SEE PAG. 326

SNODO ANTIPANICO
MECHANISM ANTIPANIC



VEDI/SEE PAG. 326

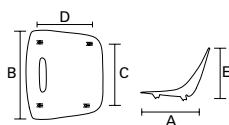
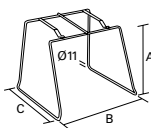
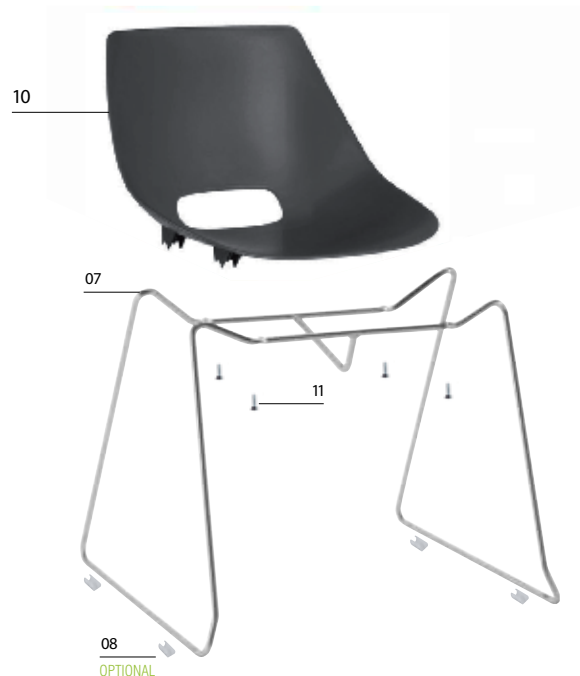

07 OKI-SGABELLO IN TONDINO PER SCOCCA CROMATO SENZA TAPPI
OKI-STOOL IN CHROME FRAME WIRE FOR SHELL WITHOUT CAPS

CODICE/CODE	FINITURA/FINISHING	Q. KIT	Q. MIN/PACK	A	B	C	KG. x1/WT.x1	VOL. x1/UNIT VOL.
113410-008	■ CROMATO/CHROME	x1	50	450	600	550	3,30	mc. 0,04

08 BASE PIANA A PINZA IN PE PER TONDO
CLIPS BASE FOR WIRE

CODICE/CODE	FINITURA/FINISHING	Q. KIT
134006-020	□ NEUTRO/NEUTRAL	x4

09 BASE PIANA A PINZA DOPPIA IN PE PER TONDO
DOUBLE FLAT CLIP BASE FOR WIRE

CODICE/CODE	FINITURA/FINISHING	Q. KIT
134006-021	□ NEUTRO/NEUTRAL	x4

10 OKI-SCOCCA INTERA MODELLO OKI
OKI-SHELL FOR OKI MODEL

CODICE/CODE	FINITURA/FINISHING	Q. KIT	Q. MIN/PACK	A	B	C	D	E	KG. x1/WT.x1	VOL. x1/UNIT VOL.
133903-050	■ NERO/BLACK	x1	10	525	530	209	306	395	1,80	mc. 0,025
133905-050	□ BIANCO/WHITE 218	x1	10	525	530	209	306	395	1,80	mc. 0,025
133915-050	■ BLU/BLUE 5002	x1	10	525	530	209	306	395	1,80	mc. 0,025

11 VITE AUTOFILETTANTE 5.5X19 TESTA CILINDRICA A CROCE ZINCATA (VITE FISSAGGIO SCOCCA)
AUTO-THREAD SCREW 5.5X19 CYLINDRICAL HEAD CROSS ZINC (SCREW FOR SHELL FIXING)

CODICE/CODE	FINITURA/FINISHING	Q. KIT
117811-180	■ ZINCATA/ZINC	x4

50
100

OPTIONAL 08
BASE PIANA A PINZA
CLIPS BASE



OPTIONAL 09
BASE PIANA A PINZA DOPPIA
DOUBLE FLAT CLIP BASE

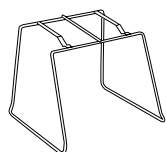
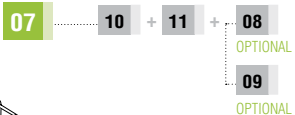

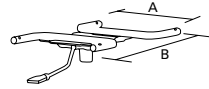

13	OKI-SUPPORTO GIREVOLE A GAS PER SCOCCA OKI OKI-GAS LIFT SWIVEL METAL FRAME FOR OKI SHELL					
	CODICE/CODE 110903-010	FINITURA/FINISHING ■ NERO/BLACK	Q. KIT x1	Q. MIN/PACK 10	A B 306 209	KG.x1/WT.x1 1,30
12	VITE HILO D.5X35 TESTA SVASATA A CROCE ZINCATA (VITE FISSAGGIO SCOCCA) CROSS SCREW HILO D.5X35 FLARED ZINC (SCREW FOR SHELL FIXING)					
	CODICE/CODE 117811-153	FINITURA/FINISHING □ ZINCATA/ZINC	Q. KIT x4			
15	TAPPO COPRITESTA ALETTATO D.18 NERO COVER HEAD D.18 BLACK					
	CODICE/CODE 134103-180	FINITURA/FINISHING ■ NERO/BLACK	Q. KIT x4			

13 **10** + **12** + **15**





PER I COMPONENTI DELLA PANCA VAI A PAG. 337
FOR THE BENCH COMPONENTS GO TO PAGE 337

14	OKI-SUPPORTO PER ATTACCO SCOCCA OKI SU PANCA SMILE-BENCH FRAME FOR OKI SHELL								
CODICE/CODE	FINITURA/FINISHING	Q. KIT	Q. MIN/PACK	A	B		KG.x1/WT.x1	VOL.x1/UNIT VOL.	
110703-053	■ NERO/BLACK	x1	15	306	209		1,40	mc. 0,004	

15	TAPPO COPRITESTA ALETTATO D.18 NERO COVER HEAD D.18 BLACK								
CODICE/CODE	FINITURA/FINISHING	Q. KIT							
134103-180	■ NERO/BLACK	x4							

10	OKI-SCOCCA INTERA MODELLO OKI OKI-SHELL FOR OKI MODEL									
CODICE/CODE	FINITURA/FINISHING	Q. KIT	Q. MIN/PACK	A	B	C	D	E	KG.x1/WT.x1	VOL.x1/UNIT VOL.
133903-050	■ NERO/BLACK	x1	10	525	530	209	306	395	1,80	mc. 0,025
133905-050	□ BIANCO/WHITE 218	x1	10	525	530	209	306	395	1,80	mc. 0,025
133915-050	■ BLU/BLUE 5002	x1	10	525	530	209	306	395	1,80	mc. 0,025

12	VITE HILO D.5X35 TESTA SVASATA A CROCE ZINCATA (VITE FISSAGGIO SCOCCA) CROSS SCREW HILO D.5X35 FLARED ZINC (SCREW FOR SHELL FIXING)								
CODICE/CODE	FINITURA/FINISHING	Q. KIT							
117811-153	■ ZINCATA/ZINC	x4							



52
OKI

14 + 10 + 12 + 15



OPTIONAL GAMBA
LEG OPTIONAL





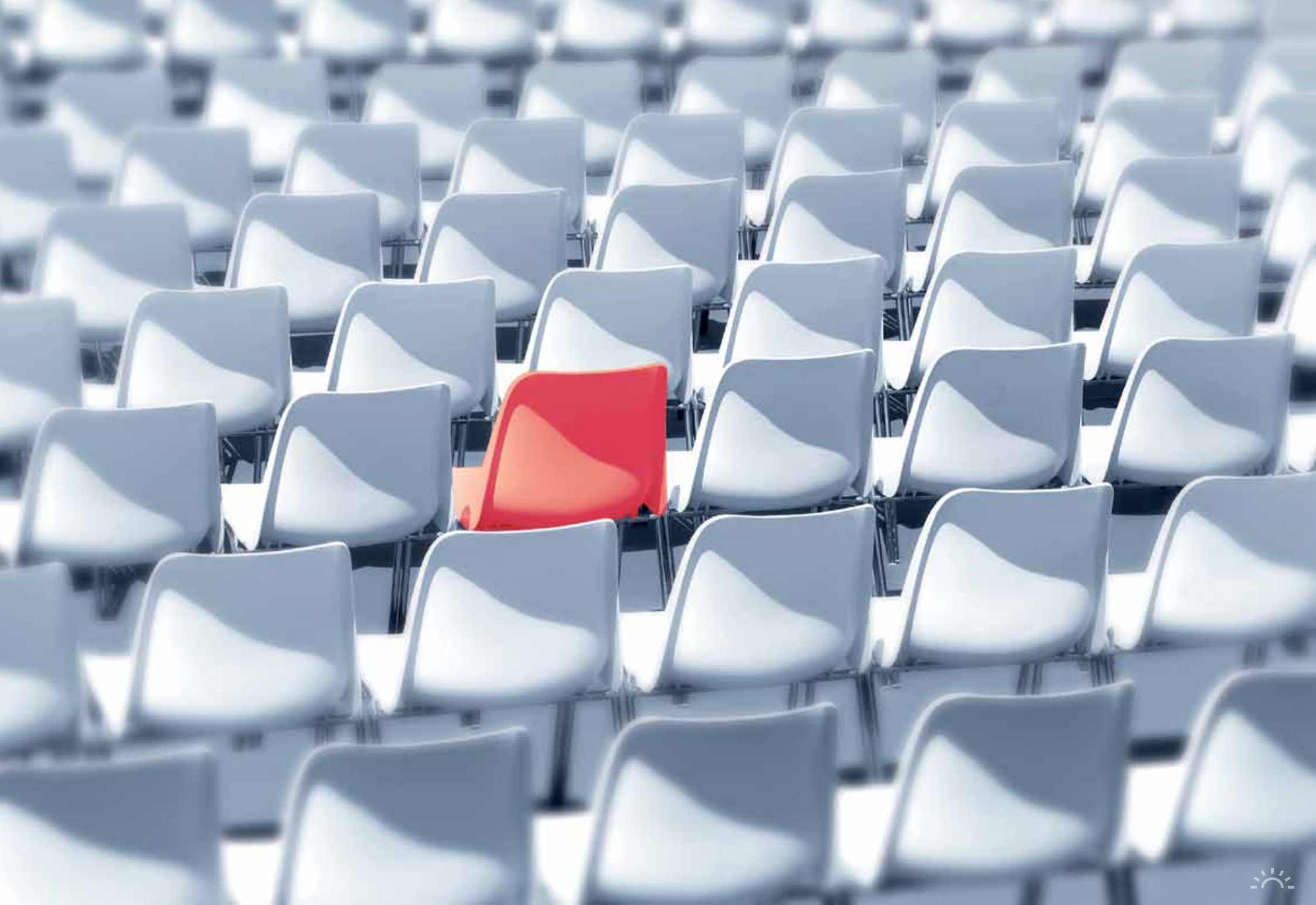



VICENZA

SLIDE

4 LEGS

SWIVEL

BENCH



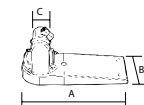
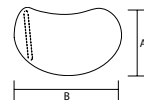
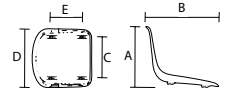
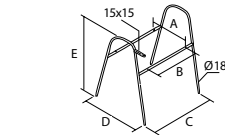

04 VICENZA-SCABELLO PER SCOCCA VICENZA CON PORTA TAV. E BRACC. IN TUBO Ø18 TAPPI MONTATI
VICENZA-STOOL FOR VICENZA WITH MECHANISM FOR LITTLE TABLE AND ARMS SHELL PIPE Ø18 INNER FEET CAPS ASSEMBLED

CODICE/CODE	FINITURA/FINISHING	Q. KIT	Q. MIN/PACK	A	B	C	D	E	KG. x1/WT.x1	VOL. x1/UNIT VOL.
111903-007	■ NERO/BLACK	x1	70	255	315	486	500	630	2,50	mc. 0,040
111910-012	■ CROMATO/CHROME	x1	70	255	315	486	500	630	2,50	mc. 0,040

05 VICENZA-SCOCCA INTERNA
VICENZA-PLASTIC SHELL

CODICE/CODE	FINITURA/FINISHING	Q. KIT	Q. MIN/PACK	A	B	C	D	E	KG. x1/WT.x1	VOL. x1/UNIT VOL.
133902-002	■ ROSSO/RED RAL 3002	x1	12	395	470	315	430	255	1,30	mc. 0,014
133903-001	■ NERO/BLACK	x1	12	395	470	315	430	255	1,30	mc. 0,014
133915-005	■ BLU/BLUE RAL 5002	x1	12	395	470	315	430	255	1,30	mc. 0,014

06 VITE AUTOFILETTANTE 5X35 TESTA SVASATA A CROCE ZINCATA PER FISSAGGIO SCOCCA
SCREW AUTO-THREAD 5X35 FLARED CROSS HEAD ZINC FOR SHELL FIXING

CODICE/CODE	FINITURA/FINISHING	Q. KIT
117811-153	■ ZINCATA/ZINC	x4

07 BEAN-TAVOLETTA IN TERMOPLASTICO SPESSORE 16 MM
BEAN-WRITING TABLET IN PLASTIC THINCKNESS 16 mm

CODICE/CODE	FINITURA/FINISHING	Q. KIT	Q. MIN/PACK	A	B	KG. x1/WT.x1	VOL. x1/UNIT VOL.
134003-044	■ NERO/BLACK	x1	20	235	370	0,40	mc. 0,002

10 SPT2-SNODO PER TAVOLETTA IN TERMOPLASTICA
SPT2-MECHANISM FOR WRITING TABLET

CODICE/CODE	FINITURA/FINISHING	Q. KIT	Q. MIN/PACK	A	B	C	KG. x1/WT.x1	VOL. x1/UNIT VOL.
134003-039	■ NERO/BLACK	x1	20	180	66	15x15	0,35	mc. 0,0006



VICENZA-CARRELLO PORTASEDIE CON ACCESSORI CROMATO
VICENZA-TROLLEY FOR CHAIRS WITH ACCESSORIES CHROME

CODICE/CODE	FINITURA/FINISHING
110810-009	■ CROMATO/CHROME

04 05 + 06 + 10 + 07

01 02 03 05 + 06

09 05 + 14 + 15



OPTIONAL

TAVOLETTA TLT1
TLT1 TABLET



VEDI/SEE PAG. 327

TAVOLETTA TLT2
TLT2 TABLET



VEDI/SEE PAG. 327

TAVOLETTA TLT3
TLT3 TABLET



VEDI/SEE PAG. 327

TAVOLETTA BEAN
BEAN TABLET



VEDI/SEE PAG. 327

TAVOLETTA TL01
TL01 TABLET



VEDI/SEE PAG. 327

SNODO TAVOLETTA SPT2
SPT2 MECHANISM TABLET



VEDI/SEE PAG. 326

SNODO ANTIPANICO
MECHANISM ANTIPANIC



VEDI/SEE PAG. 326

4 LEGS OPTIONS:



03 VICENZA-SGABELLO PER SCOCCA CON BRACCIOLI IN TUBO Ø18 TAPPI SOTTOPIEDE MONTATI
VICENZA-STOOL WITH ARMS FOR SHELL PIPE Ø18 INNER FEET CAPS ASSEMBLED

CODICE/CODE	FINITURA/FINISHING	Q.KIT	Q.MIN/PACK	A	B	C	D	E	KG.x1/WT.x1	VOL.x1/UNIT VOL.
111903-003	■ NERO/BLACK	x1	70	255	315	486	500	630	2,50	mc. 0,040
111910-010	■ CROMATO/CHROME	x1	70	255	315	486	500	630	2,50	mc. 0,040

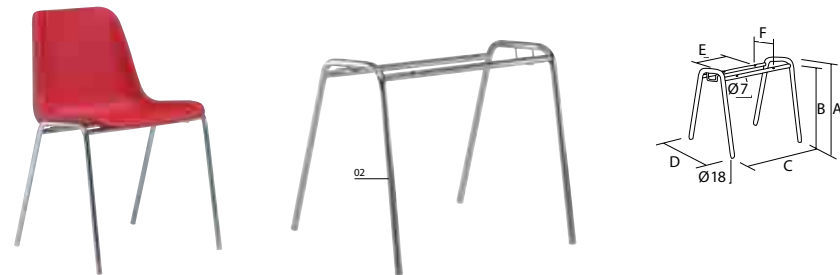

02 VICENZA-SGABELLO PER SCOCCA CON AGGANCIO IN TUBO Ø18 TAPPI SOTTOPIEDE MONTATI
VICENZA-STOOL WITH HOOK FOR SHELL PIPE Ø18 INNER FEET CAPS ASSEMBLED

CODICE/CODE	FINITURA/FINISHING	Q.KIT	Q.MIN/PACK	A	B	C	D	E	F	KG.x1/WT.x1	VOL.x1/UNIT VOL.
111903-001	■ NERO/BLACK	x1	200	470	440	486	470	315	255	2,00	mc. 0,020
111910-002	■ CROMATO/CHROME	x1	200	470	440	486	470	315	255	2,00	mc. 0,020



01 VICENZA-SGABELLO PER SCOCCA IN TUBO Ø18 TAPPI SOTTOPIEDE MONTATI
VICENZA-STOOL FOR SHELL PIPE Ø18 INNER FEET CAPS ASSEMBLED

CODICE/CODE	FINITURA/FINISHING	Q.KIT	Q.MIN/PACK	A	B	C	D	E	F	KG.x1/WT.x1	VOL.x1/UNIT VOL.
111903-002	■ NERO/BLACK	x1	200	470	440	486	470	315	255	2,00	mc. 0,020
111910-001	■ CROMATO/CHROME	x1	200	470	440	486	470	315	255	2,00	mc. 0,020

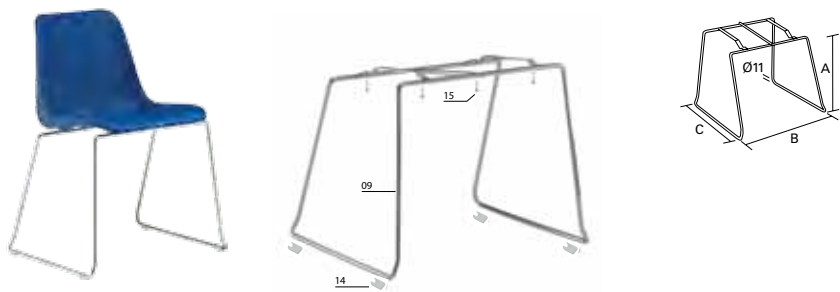

09 FILO-SGABELLO IN TONDINO PER SCOCCA VICENZA TAPPI ESCLUSI
FILO-ROUND BAR STOOL FOR VICENZA SHELL WITHOUT CAPS

CODICE/CODE	FINITURA/FINISHING	Q.KIT	Q.MIN/PACK	A	B	C	KG.x1/WT.x1	VOL.x1/UNIT VOL.
113410-010	■ CROMATO/CHROME	x1	100	470	540	480	3,15	mc. 0,04

14 BASE PIANA A PINZA IN PE PER TONDO
CLIPS BASE FOR TUBE

CODICE/CODE	FINITURA/FINISHING	Q.KIT
134006-020	□ NEUTRO/NEUTRAL	x4

15 VITE AUTOFILETTANTE TRUCIOLARE TC+ Ø 5,5X19 PER FISSAGGIO SEDILE
SCREW CHIPBOARD TC+ Ø 5,5X19 FOR FIXING SEAT

CODICE/CODE	FINITURA/FINISHING	Q.KIT
117811-180	■ ZINCATA/ZINC	x4

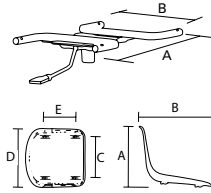

11	VICENZA GNR-SUPPORTO GIREVOLE A GAS SENZA ACCESSORI VICENZA GNR-SWIVEL METAL FRAME FOR GAS LIFT WITHOUT ACCESSORIES	CODICE/CODE 110903-006	FINITURA/FINISHING ■ NERO/BLACK	Q. KIT x1	Q. MIN/PACK 10	A 315	B 255	KG. x1/WT.x1 1,40	VOL. x1/UNIT VOL. mc. 0,004			
05	VICENZA-SCocca INTERNA VICENZA-PLASTIC SHELL	CODICE/CODE 133902-002 133903-001 133915-005	FINITURA/FINISHING ■ ROSSO/RED RAL 3002 ■ NERO/BLACK ■ BLU/BLEU RAL 5002	Q. KIT x1 x1 x1	Q. MIN/PACK 12 12 12	A 395	B 470	C 315	D 430	E 255	KG. x1/WT.x1 1,30	VOL. x1/UNIT VOL. mc. 0,014
08	VITE AUTOFILETTANTE TRUCIOLARE TSP+Ø 5x35 PER FISSAGGIO SEDILE SCREW CHIPBOARD TSP+Ø 5x35 FOR FIXING SEAT	CODICE/CODE 117811-153	FINITURA/FINISHING □ ZINCATA/ZINC	Q. KIT x4								
13	TAPPO COPRITESTA Ø18 NERO COVER HEAD D.18 BLACK	CODICE/CODE 134103-180	FINITURA/FINISHING ■ NERO/BLACK	Q. KIT x4								

11 05 + 08 + 13





PER I COMPONENTI DELLA PANCA VAI A PAG. 337
FOR THE BENCH COMPONENTS GO TO PAGE 337

12 SUPPORTO PER ATTACCO SCOCCA VICENZA SU PANCA
BENCH FRAME FOR PULL SHELL

CODICE/CODE	FINITURA/FINISHING	Q. KIT	Q. MIN/PACK	A	B	KG. x1/WT. x1	VOL. x1/UNIT VOL.
110703-016	■ NERO/BLACK	x1	10	315	255	1,40	mc. 0,004

12 05 + 08 + 13



OPTIONAL GAMBA
LEG OPTIONAL



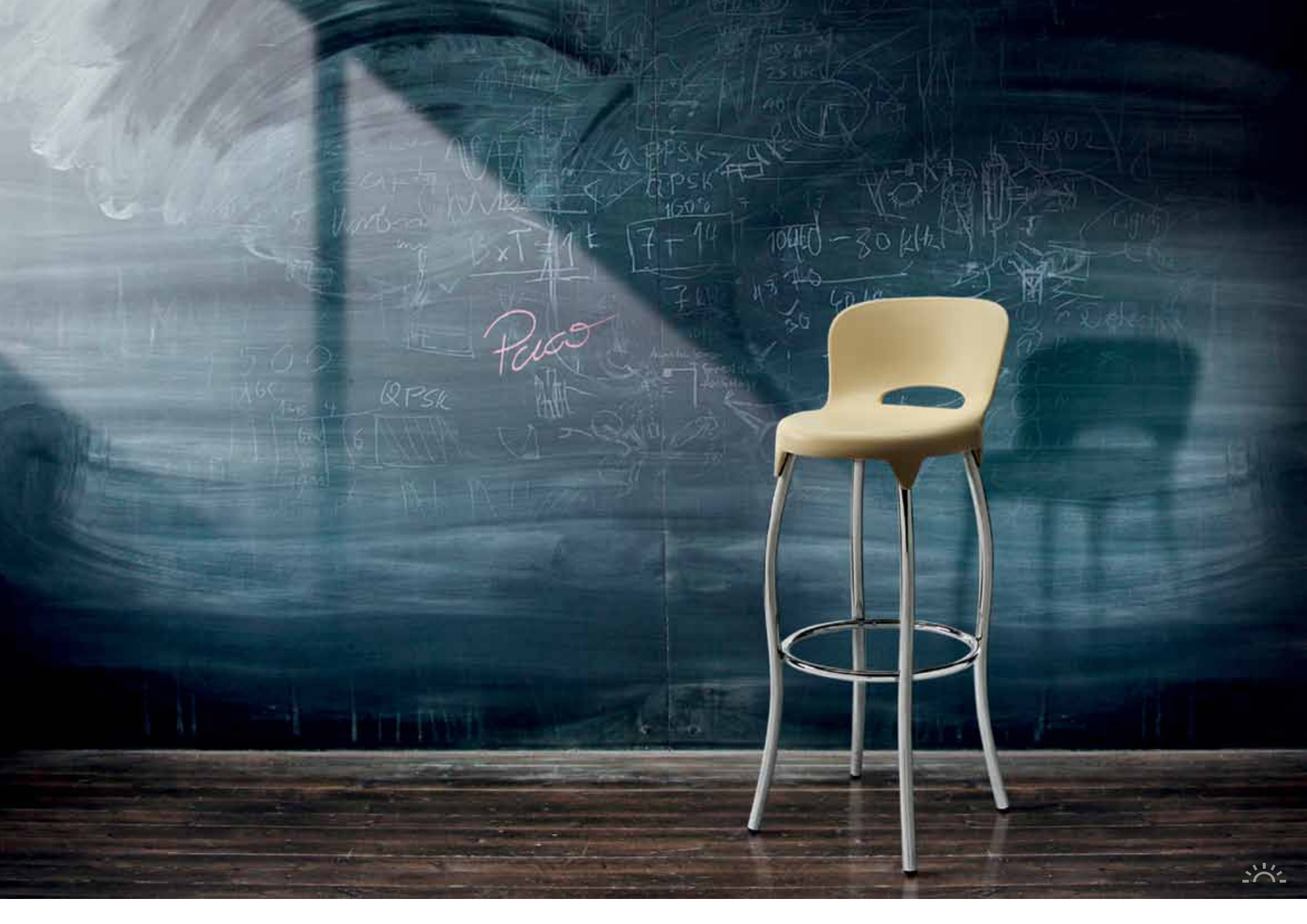

Pico





4 LEGS



PACO



PACO 4 LEGS

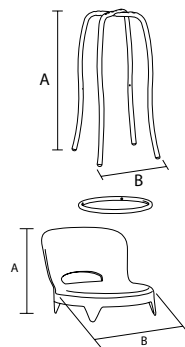
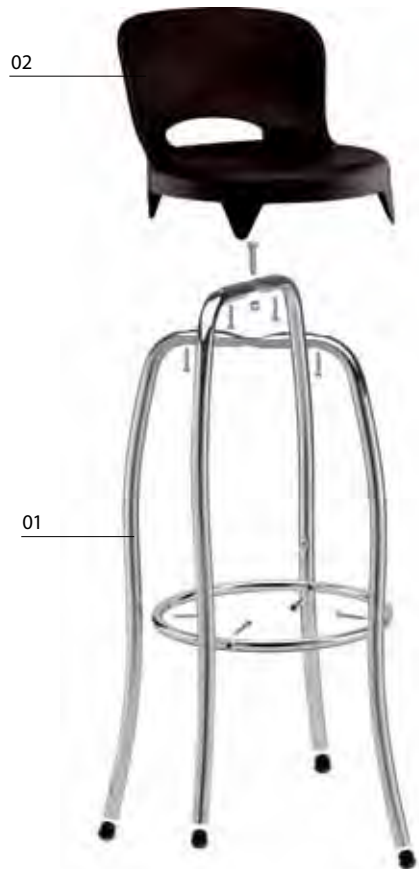

01 PACO-TELAIO SMONTATO PER SGABELLO ALTO CON ACCESSORI PER IL MONTAGGIO

PACO-FRAME NOT ASSEMBLED FOR HIGH STOOL WITH ACCESSORIES FOR ASSEMBLAGE

CODICE/CODE	FINITURA/FINISHING	Q. KIT	Q. MIN/PACK	A	B	KG.x1/WT.x1	VOL.x1/UNIT VOL.
110604-090	■ GRIGIO/GREY	x1	60	800	370	3,45	mc. 0,02
110610-080	■ CROMATO/CHROME	x1	60	800	370	3,45	mc. 0,02

02 PACO-SCocca INTERNA IN PLASTICA

PACO-PLASTIC SHELL

CODICE/CODE	FINITURA/FINISHING	P	Q. KIT	Q. MIN/PACK	A	B	KG.x1/WT.x1	VOL.x1/UNIT VOL.
133904-025	■ ANTRACITE/GREY	PPL17	x1	12	230	380	1,38	mc. 0,02
133905-040	■ BEIGE/BEIGE	PPL09	x1	12	230	380	1,38	mc. 0,02
133915-040	■ BLU/BLUE	PPL14	x1	12	230	380	1,38	mc. 0,02

LO SGABELLO STANDARD COMPRENDE LA CONFEZIONE ACCESSORI PER IL MONTAGGIO
 THE KIT OF ACCESSORIES FOR THE ASSEMBLAGE IS INCLUDED WITH THE STOOL

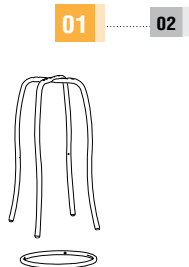







4 LEGS



ATHOS



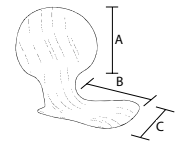
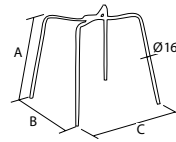
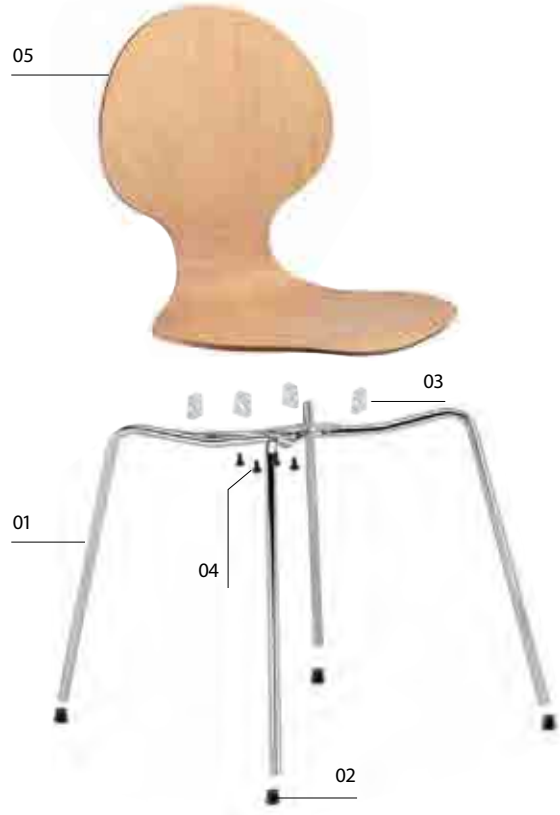

01 ATHOS-SGABELLO FISSO SENZA TAPPI ATHOS-FIXED STOOL WITHOUT CAPS									
CODICE/CODE	FINITURA/FINISHING	Q. KIT	Q. MIN/PACK	A	B	C	KG. x1/WT.x1	VOL. x1/UNIT VOL.	
110603-060	■ NERO/BLACK	x1	150	450	450	450	1,90	mc. 0,03	
110604-060	■ GRIGIO/GREY	x1	150	450	450	450	1,90	mc. 0,03	
110610-050	■ CROMATO/CHROME	x1	150	450	450	450	1,90	mc. 0,03	

02 PUNTALE ALETTATO TONDO Ø16 NERO RIBBED ROUND HEAD CAP Ø16 BLACK									
CODICE/CODE	FINITURA/FINISHING	Q. KIT							
134203-160	■ NERO/BLACK	x4							

03 PROTEZIONE IN PVC PER SCOCHE IN LEGNO PVC PROTECTION FOR WOODEN SHELL									
CODICE/CODE	Q. KIT								
134006-010	x4								

04 VITE TC + M6X12 BRUNITA NERA SCREW TC + M6X12 BURNISHING BLACK									
CODICE/CODE	FINITURA/FINISHING	Q. KIT							
117703-177	■ NERO/BLACK	x4							

05 JACK-MONSCOCCA SCHIENALE ROTONDO MULTISTRATO FAGGIO SPESSORE 10,5 MM LEVIGATO JACK-SHELL ROUND BACK MULTI-LAAYER BEECHWOOD THICKNESS 10,5 MM POLISHED									
CODICE/CODE	FINITURA/FINISHING	Q. KIT	Q. MIN/PACK	A	B	C	KG. x1/WT.x1	VOL. x1/UNIT VOL.	
123907-001	■ FAGGIO/BEECHWOOD	x1	10	400	420	450	2,50	mc. 0,02	

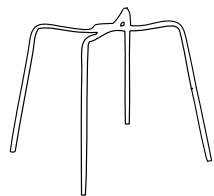
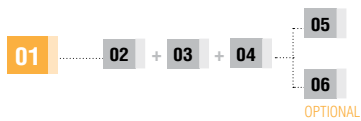

4 LEGS OPTIONS:

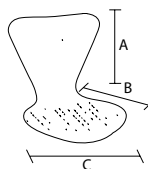

06 TREVI-MONOCOCCA SCHIENALE TRIANGOLARE MULTISTRATO FAGGIO SPESSORE 10,5 MM LEVIGATO									
TREVI-SHELL TRIANGULAR BACK MULTI-LAYER BEECHWOOD THICKNESS 10,5 mm POLISHED									
CODICE/CODE	FINITURA/FINISHING	Q.KIT	Q.MIN/PACK	A	B	C	KG.x1/WT.x1	VOL.x1/UNIT.VOL.	
123907-002	 FAGGIO/BEECHWOOD	x1	10	400	420	450	2,50	mc. 0,02	







SLIDE

4 LEGS

SWIVEL

BENCH



BIFMA TEST



EN 16139

ALBA



a:Ba

FOLLOW US ON



ABA

*AVAILABLE LEFT ARM FOR WRITING TABLET

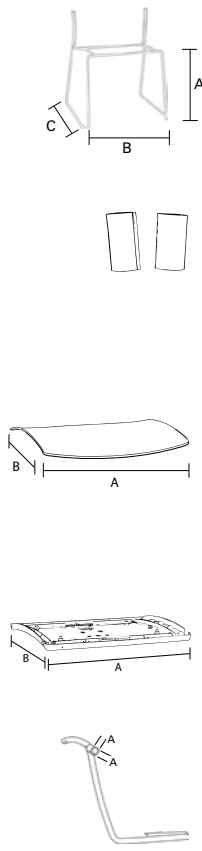

70
ABA

01 ABA-TELAIO A SLITTA IN TONDINO D.12

CODICE/CODE	FINITURA/FINISHING	Q. KIT	Q. MIN/PACK	A	B	C	KG. x1/WT.x1	VOL. x1/UNIT VOL.
111810-036	■ CROMATO/CHROME	x1	60	440	570	485	4,70	mc. 0,035

05 ABA-COPPIA INSERTI SCHIENALE DESTRO-SINISTRO PLASTICA

CODICE/CODE	FINITURA/FINISHING	Q. KIT	Q. MIN/PACK
132102-066	■ ROSSO/RED	527	x1 50
132103-066	■ NERO/BLACK	527	x1 50
132104-066	■ GRIGIO/GRAY	7035	x1 50
132105-066	□ BIANCO/WHITE	218	x1 50
132114-066	■ VIOLA/VIOLET	145	x1 50
132115-066	■ BLU/BLUE	5023	x1 50
132116-066	■ VERDE/PASTEL GREEN	6019	x1 50

06 ABA-SEDILE PLASTICA COLORATO A VISTA (TAPPEZZABILE)

CODICE/CODE	FINITURA/FINISHING	Q. KIT	Q. MIN/PACK	A	B	KG. x1/WT.x1	VOL. x1/UNIT VOL.
132202-070	■ ROSSO/RED	527	x1 10	455	470	1,32	mc. 0,01
132203-070	■ NERO/BLACK	527	x1 10	455	470	1,32	mc. 0,01
132204-070	■ GRIGIO/GRAY	7035	x1 10	455	470	1,32	mc. 0,01
132205-070	□ BIANCO/WHITE	218	x1 10	455	470	1,32	mc. 0,01
132214-070	■ VIOLA/VIOLET	145	x1 10	455	470	1,32	mc. 0,01
132215-070	■ BLU/BLUE	5023	x1 10	455	470	1,32	mc. 0,01
132216-070	■ VERDE/PASTEL GREEN	6019	x1 10	455	470	1,32	mc. 0,01

07 ABA-SOTTOSEDILE PLASTICA COLORATO A VISTA+VITI

CODICE/CODE	FINITURA/FINISHING	Q. KIT	Q. MIN/PACK	A	B	KG. x1/WT.x1	VOL. x1/UNIT VOL.
132202-071	■ ROSSO/RED	527	x1 20	430	410	0,54	mc. 0,005
132203-071	■ NERO/BLACK	527	x1 20	430	410	0,54	mc. 0,005
132204-071	■ GRIGIO/GRAY	7035	x1 20	430	410	0,54	mc. 0,005
132205-071	□ BIANCO/WHITE	218	x1 20	430	410	0,54	mc. 0,005
132214-071	■ VIOLA/VIOLET	145	x1 20	430	410	0,54	mc. 0,005
132215-071	■ BLU/BLUE	5023	x1 20	430	410	0,54	mc. 0,005
132216-071	■ VERDE/PASTEL GREEN	6019	x1 20	430	410	0,54	mc. 0,005

08 ABA-TELAIO IN FERRO PER AGGANCIAMENTO TAVOLETTA+VITI

CODICE/CODE	FINITURA/FINISHING	Q. KIT	Q. MIN/PACK	A	KG. x1/WT.x1	VOL. x1/UNIT VOL.
111703-054	■ NERO/BLACK	DESTRO/RIGHT - slitta/slide	x1 10	15x15	0,60	mc. 0,002
111703-055	■ NERO/BLACK	SINISTRO/LEFT - slitta/slide	x1 10	15x15	0,60	mc. 0,002

OPTIONAL 02
BASE PIANA A PINZA
CLIPS BASE
134006-020 / Q.KIT x4



OPTIONAL 22
BASE PIANA A PINZA DOPIA
DOUBLE FLAT CLIP BASE
134006-021 / Q.KIT x4



OPTIONAL 10
AGGANCIAMENTO LATERALE MASCHIO + FEMMINA
LINKING DEVICE MALE+FEMALE



OPTIONAL 23
BTF-KIT PIEDINI
BTF-KIT FEET
134306-001
Q.KIT x1 - Q. MIN/PACK 100



OPTIONAL 24
BTF-KIT PIEDINI CON GANCI
BTF-KIT FEET WITH HOOKS
134306-002
Q.KIT x1 - Q. MIN/PACK 100



OPTIONAL 25
PPTF-TAPPO PER FISSAGGIO PAVIMENTO
PPTF-CAP FOR FIXING TO THE FLOOR
134306-003
Q.KIT x2 - Q. MIN/PACK 100

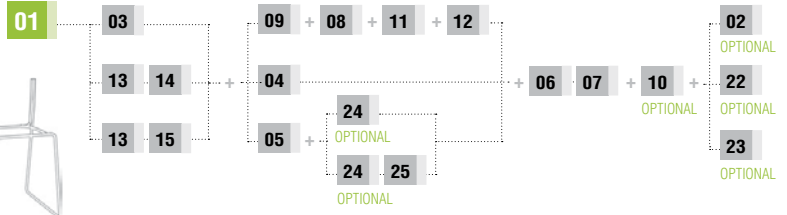

04 ABA-COPPIA BRACCIOLI DESTRO-SINISTRO PLASTICA
ABA-PAIR ARM RIGHT-LEFT PLASTIC

CODICE/CODE	FINITURA/FINISHING	Q. KIT	Q. MIN/PACK	A	KG. x1/WT.x1	VOL. x1/UNIT VOL.
131702-055	■ ROSSO/RED 527	x1	20	190	0,21	mc. 0,002
131703-055	■ NERO/BLACK	x1	20	190	0,21	mc. 0,002
131704-055	■ GRIGIO/GRAY 7035	x1	20	190	0,21	mc. 0,002
131705-055	□ BIANCO/WHITE 218	x1	20	190	0,21	mc. 0,002
131714-055	■ VIOLA/VIOLET 145	x1	20	190	0,21	mc. 0,002
131715-055	■ BLU/BLUE 5023	x1	20	190	0,21	mc. 0,002
131716-055	■ VERDE/PASTEL GREEN 6019	x1	20	190	0,21	mc. 0,002

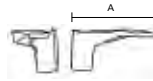

09 ABA-COPPIA BRACCIOLI DESTRO-SINISTRO PLASTICA PER TAVOLETTA
ABA-PAIR ARM RIGHT-LEFT PLASTIC FOR TABLET

CODICE/CODE	FINITURA/FINISHING	Q. KIT	Q. MIN/PACK	A	KG. x1/WT.x1	VOL. x1/UNIT VOL.
131702-056	■ ROSSO/RED 527	x1	20	190	0,21	mc. 0,002
131703-056	■ NERO/BLACK	x1	20	190	0,21	mc. 0,002
131704-056	■ GRIGIO/GRAY 7035	x1	20	190	0,21	mc. 0,002
131705-056	□ BIANCO/WHITE 218	x1	20	190	0,21	mc. 0,002
131714-056	■ VIOLA/VIOLET 145	x1	20	190	0,21	mc. 0,002
131715-056	■ BLU/BLUE 5023	x1	20	190	0,21	mc. 0,002
131716-056	■ VERDE/PASTEL GREEN 6019	x1	20	190	0,21	mc. 0,002



10 ABA-AGGANCIO LATERALE MASCHIO-FEMMINA IN PLASTICA
ABA-PLASTIC LINKING DEVICE MALE-FEMALE

CODICE/CODE	FINITURA/FINISHING	Q. KIT
134003-137	■ NERO/BLACK	x1

11 SPT2-SNODO PER TAVOLETTA IN PLASTICA
SPT2-MECHANISM FOR WRITING TABLET IN PLASTIC

CODICE/CODE	FINITURA/FINISHING	Q. KIT	Q. MIN/PACK	A	B	C	KG. x1/WT.x1	VOL. x1/UNIT VOL.
134003-039	■ NERO/BLACK	x1	20	180	66	15x15	0,35	mc. 0,0006

12 BEAN-TAVOLETTA IN PLASTICA SPESSORE 16
BEAN-WRITING TABLET IN PLASTIC THICKNESS 16 MM

CODICE/CODE	FINITURA/FINISHING	Q. KIT	Q. MIN/PACK	A	B	KG. x1/WT.x1	VOL. x1/UNIT VOL.
134003-044	■ NERO/BLACK	x1	20	235	370	0,40	mc. 0,002

13 ABA-TELAIO SCHIENALE ESTERNO PORTANTE IN PLASTICA
ABA-FRAME BACK IN PLASTIC FOR MESH

CODICE/CODE	FINITURA/FINISHING	Q. KIT	Q. MIN/PACK	A	B	KG. x1/WT.x1	VOL. x1/UNIT VOL.
132103-065	■ NERO/BLACK	x1	20	320	460	0,51	mc. 0,005

14 ABA-PANNELLO SCHIENALE IN PLASTICA DA TAPPEZZARE
ABA-FRAME BACK IN PLASTIC FOR UPHOLSTERY

CODICE/CODE	FINITURA/FINISHING	Q. KIT	Q. MIN/PACK	A	B	KG. x1/WT.x1	VOL. x1/UNIT VOL.
132103-064	■ NERO/BLACK	x1	25	250	420	0,37	mc. 0,0025

15 ABA-CORNICE SCHIENALE IN PLASTICA PER RETE
ABA-FRAME BACK IN PLASTIC MESH

CODICE/CODE	FINITURA/FINISHING	Q. KIT	Q. MIN/PACK	A	B	KG. x1/WT.x1	VOL. x1/UNIT VOL.
132103-063	■ NERO/BLACK	x1	25	250	420	0,25	mc. 0,0025

ABA-CARRELLO PORTASEDIE CON ACCESSORI
ABA-TROLLEY FOR CHAIRS WITH ACCESSORIES

CODICE/CODE	FINITURA/FINISHING
111803-030	■ NERO/BLACK
111804-036	■ GRIGIO/GRAY



OPTIONAL

- TAVOLETTA TLT**
TLT TABLET
- TAVOLETTA TLT2**
TLT2 TABLET
- TAVOLETTA TLT3**
TLT3 TABLET
- TAVOLETTA BEAN**
BEAN TABLET
- TAVOLETTA TL01**
TL01 TABLET
- SNODO TAVOLETTA SPT2**
SPT2 MECHANISM TABLET
- SNODO ANTIPANICO**
MECHANISM ANTIPANIC



VEDI/SEE PAG. 327 VEDI/SEE PAG. 327 VEDI/SEE PAG. 327 VEDI/SEE PAG. 327 VEDI/SEE PAG. 327 VEDI/SEE PAG. 326 VEDI/SEE PAG. 326

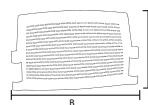
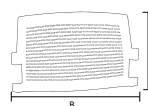
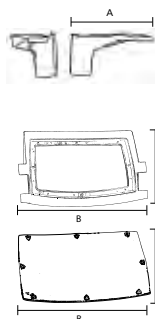

04 ABA-COPPIA BRACCIOLI DESTRO-SINISTRO PLASTICA
ABA-PAIR ARM RIGHT-LEFT PLASTIC

CODICE/CODE	FINITURA/FINISHING	Q. KIT	Q. MIN/PACK	A	KG. x1/WT.x1	VOL. x1/UNIT VOL.
131702-055	■ ROSSO/RED 527	x1	20	190	0,21	mc. 0,002
131703-055	■ NERO/BLACK	x1	20	190	0,21	mc. 0,002
131704-055	■ GRIGIO/GRAY 7035	x1	20	190	0,21	mc. 0,002
131705-055	□ BIANCO/WHITE 218	x1	20	190	0,21	mc. 0,002
131714-055	■ VIOLA/VIOLET 145	x1	20	190	0,21	mc. 0,002
131715-055	■ BLU/BLUE 5023	x1	20	190	0,21	mc. 0,002
131716-055	■ VERDE/PASTEL GREEN 6019	x1	20	190	0,21	mc. 0,002

13 ABA-TELAIO SCHIENALE ESTERNO PORTANTE IN PLASTICA
ABA-FRAME BACK IN PLASTIC FOR MESH

CODICE/CODE	FINITURA/FINISHING	Q. KIT	Q. MIN/PACK	A	B	KG. x1/WT.x1	VOL. x1/UNIT VOL.
132103-065	■ NERO/BLACK	x1	20	320	460	0,51	mc. 0,005

14 ABA-PANNELLO SCHIENALE IN PLASTICA DA TAPPEZZARE
ABA-FRAME BACK IN PLASTIC FOR UPHOLSTERY

CODICE/CODE	FINITURA/FINISHING	Q. KIT	Q. MIN/PACK	A	B	KG. x1/WT.x1	VOL. x1/UNIT VOL.
132103-064	■ NERO/BLACK	x1	25	250	420	0,37	mc. 0,0025

03 ABA-SCHIENALE PLASTICA COLORATO A VISTA
ABA-PLASTIC BACK COLORED

CODICE/CODE	FINITURA/FINISHING	Q. KIT	Q. MIN/PACK	A	B	KG. x1/WT.x1	VOL. x1/UNIT VOL.
132102-067	■ ROSSO/RED 527	x1	20	320	460	0,63	mc. 0,009
132103-067	■ NERO/BLACK	x1	20	320	460	0,63	mc. 0,009
132104-067	■ GRIGIO/GRAY 7035	x1	20	320	460	0,63	mc. 0,009
132105-067	□ BIANCO/WHITE 218	x1	20	320	460	0,63	mc. 0,009
132114-067	■ VIOLA/VIOLET 145	x1	20	320	460	0,63	mc. 0,009
132115-067	■ BLU/BLUE 5023	x1	20	320	460	0,63	mc. 0,009
132116-067	■ VERDE/PASTEL GREEN 6019	x1	20	320	460	0,63	mc. 0,009

04 ABA-COPPIA BRACCIOLI DESTRO-SINISTRO PLASTICA
ABA-PAIR ARM RIGHT-LEFT PLASTIC

CODICE/CODE	FINITURA/FINISHING	Q. KIT	Q. MIN/PACK	A	KG. x1/WT.x1	VOL. x1/UNIT VOL.
131702-055	■ ROSSO/RED 527	x1	20	190	0,21	mc. 0,002
131703-055	■ NERO/BLACK	x1	20	190	0,21	mc. 0,002
131704-055	■ GRIGIO/GRAY 7035	x1	20	190	0,21	mc. 0,002
131705-055	□ BIANCO/WHITE 218	x1	20	190	0,21	mc. 0,002
131714-055	■ VIOLA/VIOLET 145	x1	20	190	0,21	mc. 0,002
131715-055	■ BLU/BLUE 5023	x1	20	190	0,21	mc. 0,002
131716-055	■ VERDE/PASTEL GREEN 6019	x1	20	190	0,21	mc. 0,002

03 ABA-SCHIENALE PLASTICA COLORATO A VISTA
ABA-PLASTIC BACK COLORED

CODICE/CODE	FINITURA/FINISHING	Q. KIT	Q. MIN/PACK	A	B	KG. x1/WT.x1	VOL. x1/UNIT VOL.
132102-067	■ ROSSO/RED 527	x1	20	320	460	0,63	mc. 0,009
132103-067	■ NERO/BLACK	x1	20	320	460	0,63	mc. 0,009
132104-067	■ GRIGIO/GRAY 7035	x1	20	320	460	0,63	mc. 0,009
132105-067	□ BIANCO/WHITE 218	x1	20	320	460	0,63	mc. 0,009
132114-067	■ VIOLA/VIOLET 145	x1	20	320	460	0,63	mc. 0,009
132115-067	■ BLU/BLUE 5023	x1	20	320	460	0,63	mc. 0,009
132116-067	■ VERDE/PASTEL GREEN 6019	x1	20	320	460	0,63	mc. 0,009

05 ABA-COPPIA INSERTI SCHIENALE DESTRO-SINISTRO PLASTICA
ABA-PAIR BACK INSERTS RIGHT-LEFT PLASTIC

CODICE/CODE	FINITURA/FINISHING	Q. KIT	Q. MIN/PACK
132102-066	■ ROSSO/RED 527	x1	50
132103-066	■ NERO/BLACK	x1	50
132104-066	■ GRIGIO/GRAY 7035	x1	50
132105-066	□ BIANCO/WHITE 218	x1	50
132114-066	■ VIOLA/VIOLET 145	x1	50
132115-066	■ BLU/BLUE 5023	x1	50
132116-066	■ VERDE/PASTEL GREEN 6019	x1	50

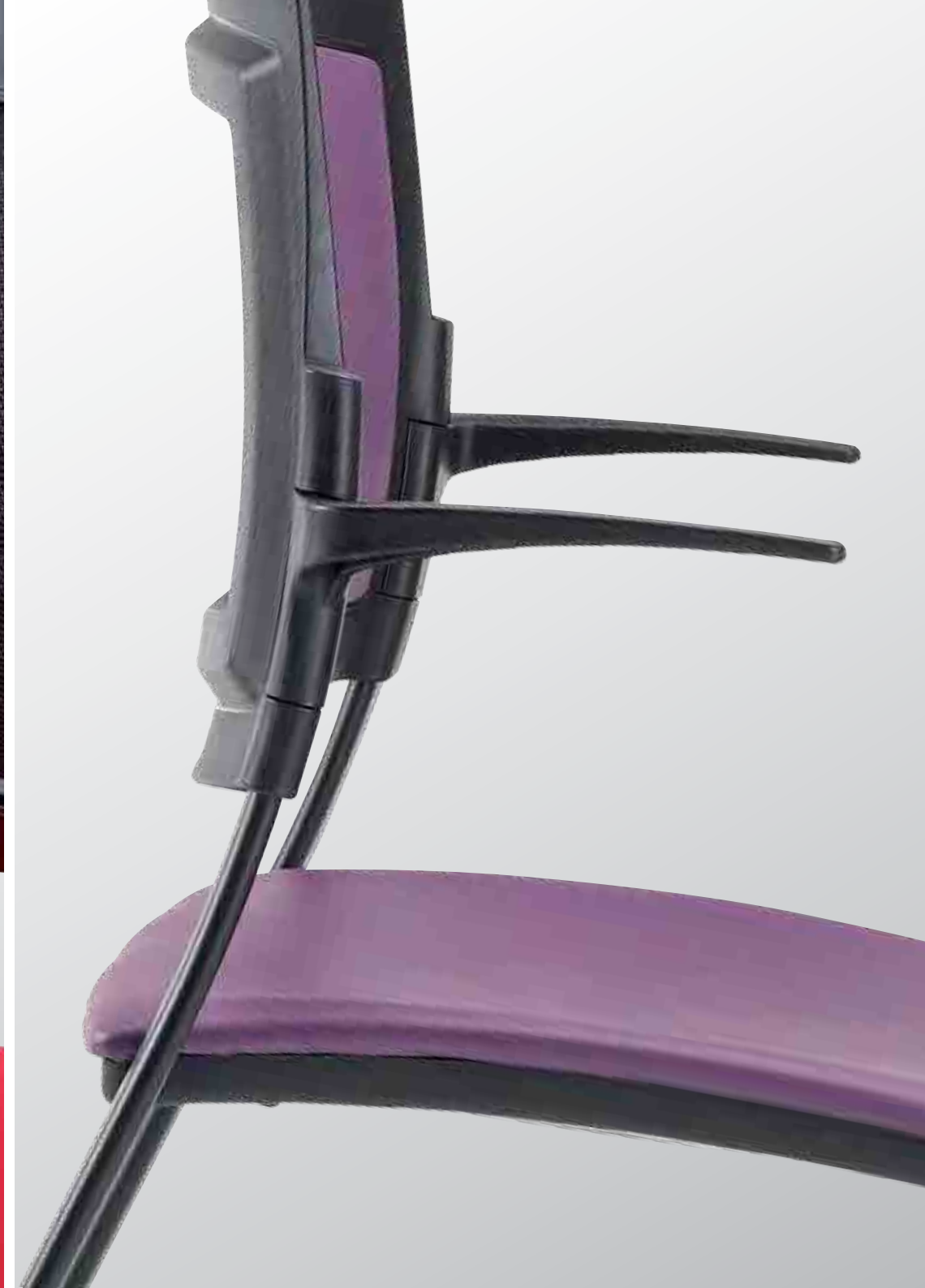

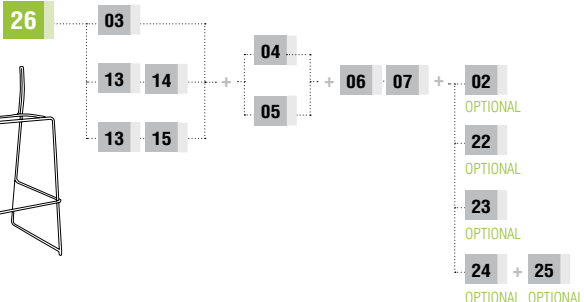
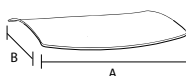
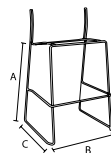

26	ABA-SGABELLO ALTO IN TONDINO CROMATO SENZA TAPPI ABA-WIRE HIGH BAR STOOL WITHOUT CAPS							
CODICE/CODE	FINITURA/FINISHING	Q. KIT	Q. MIN/PACK	A	B	C	KG. x1/WT.x1	VOL. x1/UNIT VOL.
111810-037	■ CROMATO/CHROME	x1	40	685	500	510	4,70	mc. 0,063

02	BASE PIANA A PINZA IN PE PER TONDO CLIPS BASE FOR TUBE	
CODICE/CODE	FINITURA/FINISHING	Q. KIT
134006-020	□ NEUTRO/NEUTRAL	x4

22	BASE PIANA A PINZA DOPPIA IN PE PER TONDO PER UNIONE SEDIE DOUBLE FLAT CLIP BASE FOR TUBE	
CODICE/CODE	FINITURA/FINISHING	Q. KIT
134006-021	□ NEUTRO/NEUTRAL	x4

23	BTF-KIT PIEDINI BTF-KIT FEET			
CODICE/CODE	FINITURA/FINISHING	Q. KIT	Q. MIN/PACK	KG. x1/WT.x1
134306-001	□ NEUTRO/NEUTRAL	x1	100	0,05

24	BTFA-KIT PIEDINI CON GANCI BTFA-KIT FEET WITH HOOKS			
CODICE/CODE	FINITURA/FINISHING	Q. KIT	Q. MIN/PACK	KG. x1/WT.x1
134306-002	□ NEUTRO/NEUTRAL	x1	100	0,06

25	PPTF-TAPPO PER FISSAGGIO PAVIMENTO PPTF-CAP FOR FIXING TO THE FLOOR			
CODICE/CODE	FINITURA/FINISHING	Q. KIT	Q. MIN/PACK	KG. x1/WT.x1
134306-003	□ NEUTRO/NEUTRAL	x2	100	0,03

06	ABA-SEDILE PLASTICA COLORATO A VISTA (TAPPEZZABILE) ABA-PLASTIC SEAT COLORED (TO BE UPHOLSTERED)						
CODICE/CODE	FINITURA/FINISHING	Q. KIT	Q. MIN/PACK	A	B	KG. x1/WT.x1	VOL. x1/UNIT VOL.
132202-070	■ ROSSO/RED 527	x1	10	455	470	1,32	mc. 0,01
132203-070	■ NERO/BLACK	x1	10	455	470	1,32	mc. 0,01
132204-070	■ GRIGIO/GRAY 7035	x1	10	455	470	1,32	mc. 0,01
132205-070	□ BIANCO/WHITE 218	x1	10	455	470	1,32	mc. 0,01
132214-070	■ VIOLA/VIOLET 145	x1	10	455	470	1,32	mc. 0,01
132215-070	■ BLU/BLUE 5023	x1	10	455	470	1,32	mc. 0,01
132216-070	■ VERDE/PASTEL GREEN 6019	x1	10	455	470	1,32	mc. 0,01

07	ABA-SOTTOSEDILE PLASTICA COLORATO A VISTA+VITI ABA-OUTER PLASTIC SEAT COLORED+SCREWS						
CODICE/CODE	FINITURA/FINISHING	Q. KIT	Q. MIN/PACK	A	B	KG. x1/WT.x1	VOL. x1/UNIT VOL.
132202-071	■ ROSSO/RED 527	x1	20	430	410	0,54	mc. 0,005
132203-071	■ NERO/BLACK	x1	20	430	410	0,54	mc. 0,005
132204-071	■ GRIGIO/GRAY 7035	x1	20	430	410	0,54	mc. 0,005
132205-071	□ BIANCO/WHITE 218	x1	20	430	410	0,54	mc. 0,005
132214-071	■ VIOLA/VIOLET 145	x1	20	430	410	0,54	mc. 0,005
132215-071	■ BLU/BLUE 5023	x1	20	430	410	0,54	mc. 0,005
132216-071	■ VERDE/PASTEL GREEN 6019	x1	20	430	410	0,54	mc. 0,005

- OPTIONAL 02** BASE PIANA A PINZA CLIPS BASE
- OPTIONAL 22** BASE PIANA A PINZA DOPPIA DOUBLE FLAT CLIP BASE
- OPTIONAL 23** BTF-KIT PIEDINI BTF-KIT FEET
- OPTIONAL 24** BTFA-KIT PIEDINI CON GANCI BTFA-KIT FEET WITH HOOKS
- OPTIONAL 25** PPTF-TAPPO PER FISSAGGIO PAVIMENTO PPTF-CAP FOR FIXING TO THE FLOOR



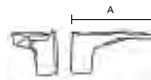
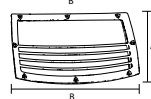
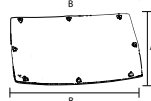
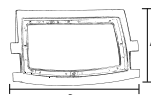
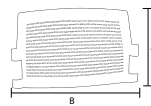

03 ABA-SCHIENALE PLASTICA COLORATO A VISTA
ABA-PLASTIC BACK COLORED

CODICE/CODE	FINITURA/FINISHING		Q. KIT	Q. MIN/PACK	A	B	KG. x1/WT.x1	VOL. x1/UNIT VOL.
132102-067	■ ROSSO/RED	527	x1	20	320	460	0,63	mc. 0,009
132103-067	■ NERO/BLACK		x1	20	320	460	0,63	mc. 0,009
132104-067	■ GRIGIO/GRAY	7035	x1	20	320	460	0,63	mc. 0,009
132105-067	□ BIANCO/WHITE	218	x1	20	320	460	0,63	mc. 0,009
132114-067	■ VIOLA/VIOLET	145	x1	20	320	460	0,63	mc. 0,009
132115-067	■ BLU/BLUE	5023	x1	20	320	460	0,63	mc. 0,009
132116-067	■ VERDE/PASTEL GREEN	6019	x1	20	320	460	0,63	mc. 0,009

13 ABA-TELAIO SCHIENALE ESTERNO PORTANTE IN PLASTICA
ABA-FRAME BACK IN PLASTIC FOR MESH

CODICE/CODE	FINITURA/FINISHING		Q. KIT	Q. MIN/PACK	A	B	KG. x1/WT.x1	VOL. x1/UNIT VOL.
132103-065	■ NERO/BLACK		x1	20	320	460	0,51	mc. 0,005

14 ABA-PANNELLO SCHIENALE IN PLASTICA DA TAPPEZZARE
ABA-FRAME BACK IN PLASTIC FOR UPHOLSTERY

CODICE/CODE	FINITURA/FINISHING		Q. KIT	Q. MIN/PACK	A	B	KG. x1/WT.x1	VOL. x1/UNIT VOL.
132103-064	■ NERO/BLACK		x1	25	250	420	0,37	mc. 0,0025

15 ABA-CORNICE SCHIENALE IN PLASTICA PER RETE
ABA-FRAME BACK IN PLASTIC MESH

CODICE/CODE	FINITURA/FINISHING		Q. KIT	Q. MIN/PACK	A	B	KG. x1/WT.x1	VOL. x1/UNIT VOL.
132103-063	■ NERO/BLACK		x1	25	250	420	0,25	mc. 0,0025

05 ABA-COPPIA INSERTI SCHIENALE DESTRO-SINISTRO PLASTICA
ABA-PAIR BACK INSERTS RIGHT-LEFT PLASTIC

CODICE/CODE	FINITURA/FINISHING		Q. KIT	Q. MIN/PACK				
132102-066	■ ROSSO/RED	527	x1	50				
132103-066	■ NERO/BLACK		x1	50				
132104-066	■ GRIGIO/GRAY	7035	x1	50				
132105-066	□ BIANCO/WHITE	218	x1	50				
132114-066	■ VIOLA/VIOLET	145	x1	50				
132115-066	■ BLU/BLUE	5023	x1	50				
132116-066	■ VERDE/PASTEL GREEN	6019	x1	50				

04 ABA-COPPIA BRACCIOLI DESTRO-SINISTRO PLASTICA
ABA-PAIR ARM RIGHT-LEFT PLASTIC

CODICE/CODE	FINITURA/FINISHING		Q. KIT	Q. MIN/PACK	A		KG. x1/WT.x1	VOL. x1/UNIT VOL.
131702-055	■ ROSSO/RED	527	x1	20	190		0,21	mc. 0,002
131703-055	■ NERO/BLACK		x1	20	190		0,21	mc. 0,002
131704-055	■ GRIGIO/GRAY	7035	x1	20	190		0,21	mc. 0,002
131705-055	□ BIANCO/WHITE	218	x1	20	190		0,21	mc. 0,002
131714-055	■ VIOLA/VIOLET	145	x1	20	190		0,21	mc. 0,002
131715-055	■ BLU/BLUE	5023	x1	20	190		0,21	mc. 0,002
131716-055	■ VERDE/PASTEL GREEN	6019	x1	20	190		0,21	mc. 0,002



03 ABA-SCHIENALE PLASTICA COLORATO A VISTA ABA-PLASTIC BACK COLORED

CODICE/CODE	FINITURA/FINISHING	Q. KIT	Q. MIN/PACK	A	B	KG. x1/WT.x1	VOL. x1/UNIT VOL.
132102-067	■ ROSSO/RED 527	x1	20	320	460	0,63	mc. 0,009
132103-067	■ NERO/BLACK	x1	20	320	460	0,63	mc. 0,009
132104-067	■ GRIGIO/GRAY 7035	x1	20	320	460	0,63	mc. 0,009
132105-067	□ BIANCO/WHITE 218	x1	20	320	460	0,63	mc. 0,009
132114-067	■ VIOLA/VIOLET 145	x1	20	320	460	0,63	mc. 0,009
132115-067	■ BLU/BLUE 5023	x1	20	320	460	0,63	mc. 0,009
132116-067	■ VERDE/PASTEL GREEN 6019	x1	20	320	460	0,63	mc. 0,009

04 ABA-COPPIA BRACCIOLI DESTRO-SINISTRO PLASTICA ABA-PAIR ARM RIGHT-LEFT PLASTIC

CODICE/CODE	FINITURA/FINISHING	Q. KIT	Q. MIN/PACK	A	KG. x1/WT.x1	VOL. x1/UNIT VOL.
131702-055	■ ROSSO/RED 527	x1	20	190	0,21	mc. 0,002
131703-055	■ NERO/BLACK	x1	20	190	0,21	mc. 0,002
131704-055	■ GRIGIO/GRAY 7035	x1	20	190	0,21	mc. 0,002
131705-055	□ BIANCO/WHITE 218	x1	20	190	0,21	mc. 0,002
131714-055	■ VIOLA/VIOLET 145	x1	20	190	0,21	mc. 0,002
131715-055	■ BLU/BLUE 5023	x1	20	190	0,21	mc. 0,002
131716-055	■ VERDE/PASTEL GREEN 6019	x1	20	190	0,21	mc. 0,002

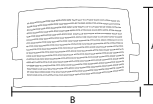

03 ABA-SCHIENALE PLASTICA COLORATO A VISTA ABA-PLASTIC BACK COLORED

CODICE/CODE	FINITURA/FINISHING	Q. KIT	Q. MIN/PACK	A	B	KG. x1/WT.x1	VOL. x1/UNIT VOL.
132102-067	■ ROSSO/RED 527	x1	20	320	460	0,63	mc. 0,009
132103-067	■ NERO/BLACK	x1	20	320	460	0,63	mc. 0,009
132104-067	■ GRIGIO/GRAY 7035	x1	20	320	460	0,63	mc. 0,009
132105-067	□ BIANCO/WHITE 218	x1	20	320	460	0,63	mc. 0,009
132114-067	■ VIOLA/VIOLET 145	x1	20	320	460	0,63	mc. 0,009
132115-067	■ BLU/BLUE 5023	x1	20	320	460	0,63	mc. 0,009
132116-067	■ VERDE/PASTEL GREEN 6019	x1	20	320	460	0,63	mc. 0,009

05 ABA-COPPIA INSERTI SCHIENALE DESTRO-SINISTRO PLASTICA ABA-PAIR BACK INSERTS RIGHT-LEFT PLASTIC

CODICE/CODE	FINITURA/FINISHING	Q. KIT	Q. MIN/PACK
132102-066	■ ROSSO/RED 527	x1	50
132103-066	■ NERO/BLACK	x1	50
132104-066	■ GRIGIO/GRAY 7035	x1	50
132105-066	□ BIANCO/WHITE 218	x1	50
132114-066	■ VIOLA/VIOLET 145	x1	50
132115-066	■ BLU/BLUE 5023	x1	50
132116-066	■ VERDE/PASTEL GREEN 6019	x1	50

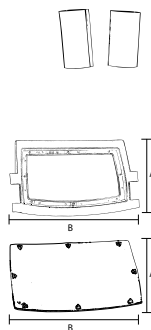

05 ABA-COPPIA INSERTI SCHIENALE DESTRO-SINISTRO PLASTICA
ABA-PAIR BACK INSERTS RIGHT-LEFT PLASTIC

CODICE/CODE	FINITURA/FINISHING		Q. KIT	Q. MIN/PACK
132102-066	■ ROSSO/RED	527	x1	50
132103-066	■ NERO/BLACK		x1	50
132104-066	■ GRIGIO/GRAY	7035	x1	50
132105-066	□ BIANCO/WHITE	218	x1	50
132114-066	■ VIOLA/VIOLET	145	x1	50
132115-066	■ BLU/BLUE	5023	x1	50
132116-066	■ VERDE/PASTEL GREEN	6019	x1	50

13 ABA-TELAIO SCHIENALE ESTERNO PORTANTE IN PLASTICA
ABA-FRAME BACK IN PLASTIC FOR MESH

CODICE/CODE	FINITURA/FINISHING	Q. KIT	Q. MIN/PACK	A	B	KG. x1/WT.x1	VOL. x1/UNIT VOL.
132103-065	■ NERO/BLACK	x1	20	320	460	0,51	mc. 0,005

14 ABA-PANNELLO SCHIENALE IN PLASTICA DA TAPPEZZARE
ABA-FRAME BACK IN PLASTIC FOR UPHOLSTERY

CODICE/CODE	FINITURA/FINISHING	Q. KIT	Q. MIN/PACK	A	B	KG. x1/WT.x1	VOL. x1/UNIT VOL.
132103-064	■ NERO/BLACK	x1	25	250	420	0,37	mc. 0,0025

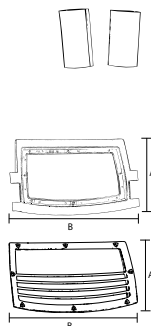

05 ABA-COPPIA INSERTI SCHIENALE DESTRO-SINISTRO PLASTICA
ABA-PAIR BACK INSERTS RIGHT-LEFT PLASTIC

CODICE/CODE	FINITURA/FINISHING		Q. KIT	Q. MIN/PACK
132102-066	■ ROSSO/RED	527	x1	50
132103-066	■ NERO/BLACK		x1	50
132104-066	■ GRIGIO/GRAY	7035	x1	50
132105-066	□ BIANCO/WHITE	218	x1	50
132114-066	■ VIOLA/VIOLET	145	x1	50
132115-066	■ BLU/BLUE	5023	x1	50
132116-066	■ VERDE/PASTEL GREEN	6019	x1	50

13 ABA-TELAIO SCHIENALE ESTERNO PORTANTE IN PLASTICA
ABA-FRAME BACK IN PLASTIC FOR MESH

CODICE/CODE	FINITURA/FINISHING	Q. KIT	Q. MIN/PACK	A	B	KG. x1/WT.x1	VOL. x1/UNIT VOL.
132103-065	■ NERO/BLACK	x1	20	320	460	0,51	mc. 0,005

15 ABA-CORNICE SCHIENALE IN PLASTICA PER RETE
ABA-FRAME BACK IN PLASTIC MESH

CODICE/CODE	FINITURA/FINISHING	Q. KIT	Q. MIN/PACK	A	B	KG. x1/WT.x1	VOL. x1/UNIT VOL.
132103-063	■ NERO/BLACK	x1	25	250	420	0,25	mc. 0,0025

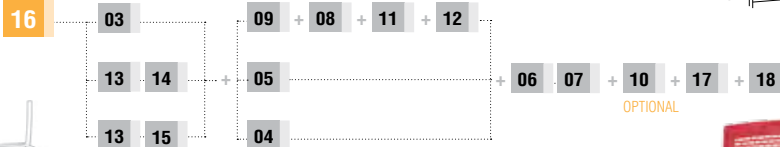
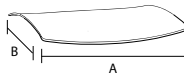
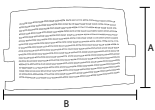
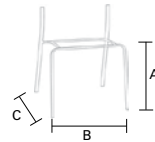

16 ABA-TELAIO 4 GAMBE IN OVALE

ABA-OVAL FRAME 4 LEGS

CODICE/CODE	FINITURA/FINISHING	Q. KIT	Q. MIN/PACK	A	B	C	KG.x1/WT.x1	VOL.x1/UNIT VOL.
111803-035	■ NERO/BLACK	x1	80	440	530	510	3,70	mc. 0,035
111804-035	■ GRIGIO/GREY	x1	80	440	530	510	3,70	mc. 0,035
111810-035	■ CROMATO/CHROME	x1	80	440	530	510	3,70	mc. 0,035

17 PUNTALE ALETTATO OVALE 25X12 ANTERIORE INCLINATO

OVAL INCLINED RIBBED INSERT 25X12 ANTERIOR

CODICE/CODE	FINITURA/FINISHING	Q. KIT
134203-015	■ NERO/BLACK	x2

18 PUNTALE ALETTATO OVALE 25X12 POSTERIORE INCLINATO

OVAL INCLINED RIBBED INSERT 25X12 POSTERIOR

CODICE/CODE	FINITURA/FINISHING	Q. KIT
134203-014	■ NERO/BLACK	x2

03 ABA-SCHIENALE PLASTICA COLORATO A VISTA

ABA-PLASTIC BACK COLORED

CODICE/CODE	FINITURA/FINISHING	Q. KIT	Q. MIN/PACK	A	B	KG.x1/WT.x1	VOL.x1/UNIT VOL.
132102-067	■ ROSSO/RED 527	x1	20	320	460	0,63	mc. 0,009
132103-067	■ NERO/BLACK	x1	20	320	460	0,63	mc. 0,009
132104-067	■ GRIGIO/GRAY 7035	x1	20	320	460	0,63	mc. 0,009
132105-067	□ BIANCO/WHITE 218	x1	20	320	460	0,63	mc. 0,009
132114-067	■ VIOLA/VIOLET 145	x1	20	320	460	0,63	mc. 0,009
132115-067	■ BLU/BLUE 5023	x1	20	320	460	0,63	mc. 0,009
132116-067	■ VERDE/PASTEL GREEN 6019	x1	20	320	460	0,63	mc. 0,009

05 ABA-COPPIA INSERTI SCHIENALE DESTRO-SINISTRO PLASTICA

ABA-PAIR BACK INSERTS RIGHT-LEFT PLASTIC

CODICE/CODE	FINITURA/FINISHING	Q. KIT	Q. MIN/PACK
132102-066	■ ROSSO/RED 527	x1	50
132103-066	■ NERO/BLACK	x1	50
132104-066	■ GRIGIO/GRAY 7035	x1	50
132105-066	□ BIANCO/WHITE 218	x1	50
132114-066	■ VIOLA/VIOLET 145	x1	50
132115-066	■ BLU/BLUE 5023	x1	50
132116-066	■ VERDE/PASTEL GREEN 6019	x1	50

06 ABA-SEDILE PLASTICA COLORATO A VISTA (TAPPEZZABILE)

ABA-PLASTIC SEAT COLORED (TO BE UPHOLSTERED)

CODICE/CODE	FINITURA/FINISHING	Q. KIT	Q. MIN/PACK	A	B	KG.x1/WT.x1	VOL.x1/UNIT VOL.
132202-070	■ ROSSO/RED 527	x1	10	455	470	1,32	mc. 0,01
132203-070	■ NERO/BLACK	x1	10	455	470	1,32	mc. 0,01
132204-070	■ GRIGIO/GRAY 7035	x1	10	455	470	1,32	mc. 0,01
132205-070	□ BIANCO/WHITE 218	x1	10	455	470	1,32	mc. 0,01
132214-070	■ VIOLA/VIOLET 145	x1	10	455	470	1,32	mc. 0,01
132215-070	■ BLU/BLUE 5023	x1	10	455	470	1,32	mc. 0,01
132216-070	■ VERDE/PASTEL GREEN 6019	x1	10	455	470	1,32	mc. 0,01

07 ABA-SOTTOSEDILE PLASTICA COLORATO A VISTA+VITI

ABA-OUTER PLASTIC SEAT COLORED+SCREWS

CODICE/CODE	FINITURA/FINISHING	Q. KIT	Q. MIN/PACK	A	B	KG.x1/WT.x1	VOL.x1/UNIT VOL.
132202-071	■ ROSSO/RED 527	x1	20	430	410	0,54	mc. 0,005
132203-071	■ NERO/BLACK	x1	20	430	410	0,54	mc. 0,005
132204-071	■ GRIGIO/GRAY 7035	x1	20	430	410	0,54	mc. 0,005
132205-071	□ BIANCO/WHITE 218	x1	20	430	410	0,54	mc. 0,005
132214-071	■ VIOLA/VIOLET 145	x1	20	430	410	0,54	mc. 0,005
132215-071	■ BLU/BLUE 5023	x1	20	430	410	0,54	mc. 0,005
132216-071	■ VERDE/PASTEL GREEN 6019	x1	20	430	410	0,54	mc. 0,005

04 ABA-COPPIA BRACCIOLI DESTRO-SINISTRO PLASTICA
ABA-PAIR ARM RIGHT-LEFT PLASTIC

CODICE/CODE	FINITURA/FINISHING	Q. KIT	Q. MIN/PACK	A	KG. x1/WT.x1	VOL. x1/UNIT VOL.
131702-055	■ ROSSO/RED 527	x1	20	190	0,21	mc. 0,002
131703-055	■ NERO/BLACK	x1	20	190	0,21	mc. 0,002
131704-055	■ GRIGIO/GRAY 7035	x1	20	190	0,21	mc. 0,002
131705-055	□ BIANCO/WHITE 218	x1	20	190	0,21	mc. 0,002
131714-055	■ VIOLA/VIOLET 145	x1	20	190	0,21	mc. 0,002
131715-055	■ BLU/BLUE 5023	x1	20	190	0,21	mc. 0,002
131716-055	■ VERDE/PASTEL GREEN 6019	x1	20	190	0,21	mc. 0,002

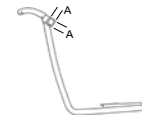
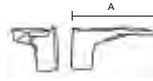

08 ABA-TELAIO IN FE PER AGGANCIAMENTO TAVOLETTA+VITI
ABA-METAL FRAME WHIT TABLE HOOK + SCREWS

CODICE/CODE	FINITURA/FINISHING	Q. KIT	Q. MIN/PACK	A	KG. x1/WT.x1	VOL. x1/UNIT VOL.
111703-050	■ NERO/BLACK DESTRO/RIGHT - 4 gambe/4 legs x1	10	10	15x15	0,60	mc. 0,002
111703-053	■ NERO/BLACK SINISTRO/LEFT - 4 gambe/4 legs x1	10	10	15x15	0,60	mc. 0,002

09 ABA-COPPIA BRACCIOLI DESTRO-SINISTRO PLASTICA PER TAVOLETTA
ABA-PAIR ARM RIGHT-LEFT PLASTIC FOR TABLE

CODICE/CODE	FINITURA/FINISHING	Q. KIT	Q. MIN/PACK	A	KG. x1/WT.x1	VOL. x1/UNIT VOL.
131702-056	■ ROSSO/RED 527	x1	20	190	0,21	mc. 0,002
131703-056	■ NERO/BLACK	x1	20	190	0,21	mc. 0,002
131704-056	■ GRIGIO/GRAY 7035	x1	20	190	0,21	mc. 0,002
131705-056	□ BIANCO/WHITE 218	x1	20	190	0,21	mc. 0,002
131714-056	■ VIOLA/VIOLET 145	x1	20	190	0,21	mc. 0,002
131715-056	■ BLU/BLUE 5023	x1	20	190	0,21	mc. 0,002
131716-056	■ VERDE/PASTEL GREEN 6019	x1	20	190	0,21	mc. 0,002

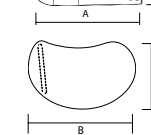
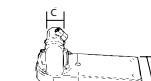

10 ABA-AGGANCIAMENTO LATERALE MASCHIO-FEMMINA IN PLASTICA
ABA-PLASTIC LINKING DEVICE MALE+FEMALE

CODICE/CODE	FINITURA/FINISHING	Q. KIT
134003-137	■ NERO/BLACK	x1

11 SPT2-SNODO PER TAVOLETTA IN PLASTICA
SPT2-MECHANISM FOR WRITING TABLET IN PLASTIC

CODICE/CODE	FINITURA/FINISHING	Q. KIT	Q. MIN/PACK	A	B	C	KG. x1/WT.x1	VOL. x1/UNIT VOL.
134003-039	■ NERO/BLACK	x1	20	180	66	15x15	0,35	mc. 0,0006

12 BEAN-TAVOLETTA IN PLASTICA SPESSORE 16
BEAN-WRITING TABLET IN PLASTIC THICKNESS 16 MM

CODICE/CODE	FINITURA/FINISHING	Q. KIT	Q. MIN/PACK	A	B	KG. x1/WT.x1	VOL. x1/UNIT VOL.
134003-044	■ NERO/BLACK	x1	20	235	370	0,40	mc. 0,002

OPTIONAL 10

AGGANCIAMENTO LATERALE MASCHIO + FEMMINA
LINKING DEVICE MALE+FEMALE



ABA-CARRELLO PORTASEDIE CON ACCESSORI
ABA-TROLLEY FOR CHAIRS WITH ACCESSORIES

CODICE/CODE	FINITURA/FINISHING
111803-030	■ NERO/BLACK
111804-036	■ GRIGIO/GRAY

OPTIONAL

TAVOLETTA TLT
TLT TABLET



VEDI/SEE PAG. 327

TAVOLETTA TLT2
TLT2 TABLET



VEDI/SEE PAG. 327

TAVOLETTA TLT3
TLT3 TABLET



VEDI/SEE PAG. 327

TAVOLETTA BEAN
BEAN TABLET



VEDI/SEE PAG. 327

TAVOLETTA TL01
TL01 TABLET



VEDI/SEE PAG. 327

SNODO TAVOLETTA SPT2
SPT2 MECHANISM TABLET



VEDI/SEE PAG. 326

SNODO ANTIPANICO
MECHANISM ANTIPANICO



VEDI/SEE PAG. 326

4 LEGS OPTIONS:

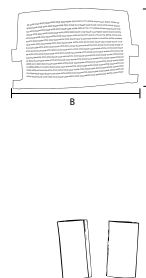
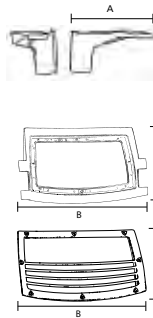
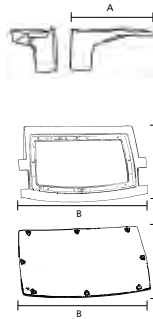

04 ABA-COPPIA BRACCIOLI DESTRO-SINISTRO PLASTICA
ABA-PAIR ARM RIGHT-LEFT PLASTIC

CODICE/CODE	FINITURA/FINISHING	Q. KIT	Q. MIN/PACK	A	KG. x1/WT.x1	VOL. x1/UNIT VOL.
131702-055	■ ROSSO/RED 527	x1	20	190	0,21	mc. 0,002
131703-055	■ NERO/BLACK	x1	20	190	0,21	mc. 0,002
131704-055	■ GRIGIO/GRAY 7035	x1	20	190	0,21	mc. 0,002
131705-055	□ BIANCO/WHITE 218	x1	20	190	0,21	mc. 0,002
131714-055	■ VIOLA/VIOLET 145	x1	20	190	0,21	mc. 0,002
131715-055	■ BLU/BLUE 5023	x1	20	190	0,21	mc. 0,002
131716-055	■ VERDE/PASTEL GREEN 6019	x1	20	190	0,21	mc. 0,002

13 ABA-TELAIO SCHIENALE ESTERNO PORTANTE IN PLASTICA
ABA-FRAME BACK IN PLASTIC FOR MESH

CODICE/CODE	FINITURA/FINISHING	Q. KIT	Q. MIN/PACK	A	B	KG. x1/WT.x1	VOL. x1/UNIT VOL.
132103-065	■ NERO/BLACK	x1	20	320	460	0,51	mc. 0,005

14 ABA-PANNELLO SCHIENALE IN PLASTICA DA TAPPEZZARE
ABA-FRAME BACK IN PLASTIC FOR UPHOLSTERY

CODICE/CODE	FINITURA/FINISHING	Q. KIT	Q. MIN/PACK	A	B	KG. x1/WT.x1	VOL. x1/UNIT VOL.
132103-064	■ NERO/BLACK	x1	25	250	420	0,37	mc. 0,0025

04 ABA-COPPIA BRACCIOLI DESTRO-SINISTRO PLASTICA
ABA-PAIR ARM RIGHT-LEFT PLASTIC

CODICE/CODE	FINITURA/FINISHING	Q. KIT	Q. MIN/PACK	A	KG. x1/WT.x1	VOL. x1/UNIT VOL.
131702-055	■ ROSSO/RED 527	x1	20	190	0,21	mc. 0,002
131703-055	■ NERO/BLACK	x1	20	190	0,21	mc. 0,002
131704-055	■ GRIGIO/GRAY 7035	x1	20	190	0,21	mc. 0,002
131705-055	□ BIANCO/WHITE 218	x1	20	190	0,21	mc. 0,002
131714-055	■ VIOLA/VIOLET 145	x1	20	190	0,21	mc. 0,002
131715-055	■ BLU/BLUE 5023	x1	20	190	0,21	mc. 0,002
131716-055	■ VERDE/PASTEL GREEN 6019	x1	20	190	0,21	mc. 0,002

13 ABA-TELAIO SCHIENALE ESTERNO PORTANTE IN PLASTICA
ABA-FRAME BACK IN PLASTIC FOR MESH

CODICE/CODE	FINITURA/FINISHING	Q. KIT	Q. MIN/PACK	A	B	KG. x1/WT.x1	VOL. x1/UNIT VOL.
132103-065	■ NERO/BLACK	x1	20	320	460	0,51	mc. 0,005

15 ABA-CORNICE SCHIENALE IN PLASTICA PER RETE
ABA-FRAME BACK IN PLASTIC MESH

CODICE/CODE	FINITURA/FINISHING	Q. KIT	Q. MIN/PACK	A	B	KG. x1/WT.x1	VOL. x1/UNIT VOL.
132103-063	■ NERO/BLACK	x1	25	250	420	0,25	mc. 0,0025

03 ABA-SCHIENALE PLASTICA COLORATO A VISTA
ABA-PLASTIC BACK COLORED

CODICE/CODE	FINITURA/FINISHING	Q. KIT	Q. MIN/PACK	A	B	KG. x1/WT.x1	VOL. x1/UNIT VOL.
132102-067	■ ROSSO/RED 527	x1	20	320	460	0,63	mc. 0,009
132103-067	■ NERO/BLACK	x1	20	320	460	0,63	mc. 0,009
132104-067	■ GRIGIO/GRAY 7035	x1	20	320	460	0,63	mc. 0,009
132105-067	□ BIANCO/WHITE 218	x1	20	320	460	0,63	mc. 0,009
132114-067	■ VIOLA/VIOLET 145	x1	20	320	460	0,63	mc. 0,009
132115-067	■ BLU/BLUE 5023	x1	20	320	460	0,63	mc. 0,009
132116-067	■ VERDE/PASTEL GREEN 6019	x1	20	320	460	0,63	mc. 0,009

05 ABA-COPPIA INSERTI SCHIENALE DESTRO-SINISTRO PLASTICA
ABA-PAIR BACK INSERTS RIGHT-LEFT PLASTIC

CODICE/CODE	FINITURA/FINISHING	Q. KIT	Q. MIN/PACK
132102-066	■ ROSSO/RED 527	x1	50
132103-066	■ NERO/BLACK	x1	50
132104-066	■ GRIGIO/GRAY 7035	x1	50
132105-066	□ BIANCO/WHITE 218	x1	50
132114-066	■ VIOLA/VIOLET 145	x1	50
132115-066	■ BLU/BLUE 5023	x1	50
132116-066	■ VERDE/PASTEL GREEN 6019	x1	50



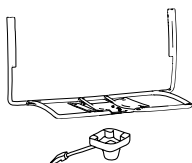
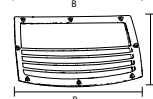
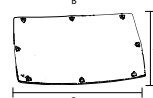
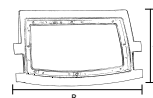
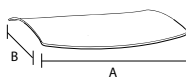
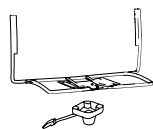

19 ABA-TELAIO GIREVOLE GAS C/BLOCCHETTO					
ABA-SWIVEL FRAME GAS WITH LEVER					
CODICE/CODE	FINITURA/FINISHING	Q. KIT	Q. MIN/PACK	KG. x1/WT.x1	VOL. x1/UNIT VOL.
111803-036	■ NERO/BLACK	x1	100	3,22	mc. 0,02

04 ABA-COPPIA BRACCIOLI DESTRO-SINISTRO PLASTICA						
ABA-PAIR ARM RIGHT-LEFT PLASTIC						
CODICE/CODE	FINITURA/FINISHING	Q. KIT	Q. MIN/PACK	A	KG. x1/WT.x1	VOL. x1/UNIT VOL.
131702-055	■ ROSSO/RED 527	x1	20	190	0,21	mc. 0,002
131703-055	■ NERO/BLACK	x1	20	190	0,21	mc. 0,002
131704-055	■ GRIGIO/GRAY 7035	x1	20	190	0,21	mc. 0,002
131705-055	□ BIANCO/WHITE 218	x1	20	190	0,21	mc. 0,002
131714-055	■ VIOLA/VIOLET 145	x1	20	190	0,21	mc. 0,002
131715-055	■ BLU/BLUE 5023	x1	20	190	0,21	mc. 0,002
131716-055	■ VERDE/PASTEL GREEN 6019	x1	20	190	0,21	mc. 0,002

05 ABA-COPPIA INSERTI SCHIENALE DESTRO-SINISTRO PLASTICA						
ABA-PAIR BACK INSERTS RIGHT-LEFT PLASTIC						
CODICE/CODE	FINITURA/FINISHING	Q. KIT	Q. MIN/PACK	A	KG. x1/WT.x1	VOL. x1/UNIT VOL.
132102-066	■ ROSSO/RED 527	x1	50			
132103-066	■ NERO/BLACK	x1	50			
132104-066	■ GRIGIO/GRAY 7035	x1	50			
132105-066	□ BIANCO/WHITE 218	x1	50			
132114-066	■ VIOLA/VIOLET 145	x1	50			
132115-066	■ BLU/BLUE 5023	x1	50			
132116-066	■ VERDE/PASTEL GREEN 6019	x1	50			

06 ABA-SEDILE PLASTICA COLORATO A VISTA (TAPPEZZABILE)							
ABA-PLASTIC SEAT COLORED (TO BE UPHOLSTERED)							
CODICE/CODE	FINITURA/FINISHING	Q. KIT	Q. MIN/PACK	A	B	KG. x1/WT.x1	VOL. x1/UNIT VOL.
132202-070	■ ROSSO/RED 527	x1	10	455	470	1,32	mc. 0,01
132203-070	■ NERO/BLACK	x1	10	455	470	1,32	mc. 0,01
132204-070	■ GRIGIO/GRAY 7035	x1	10	455	470	1,32	mc. 0,01
132205-070	□ BIANCO/WHITE 218	x1	10	455	470	1,32	mc. 0,01
132214-070	■ VIOLA/VIOLET 145	x1	10	455	470	1,32	mc. 0,01
132215-070	■ BLU/BLUE 5023	x1	10	455	470	1,32	mc. 0,01
132216-070	■ VERDE/PASTEL GREEN 6019	x1	10	455	470	1,32	mc. 0,01

07 ABA-SOTTOSDILE PLASTICA COLORATO A VISTA+VITI							
ABA-OUTER PLASTIC SEAT COLORED+SCREWS							
CODICE/CODE	FINITURA/FINISHING	Q. KIT	Q. MIN/PACK	A	B	KG. x1/WT.x1	VOL. x1/UNIT VOL.
132202-071	■ ROSSO/RED 527	x1	20	430	410	0,54	mc. 0,005
132203-071	■ NERO/BLACK	x1	20	430	410	0,54	mc. 0,005
132204-071	■ GRIGIO/GRAY 7035	x1	20	430	410	0,54	mc. 0,005
132205-071	□ BIANCO/WHITE 218	x1	20	430	410	0,54	mc. 0,005
132214-071	■ VIOLA/VIOLET 145	x1	20	430	410	0,54	mc. 0,005
132215-071	■ BLU/BLUE 5023	x1	20	430	410	0,54	mc. 0,005
132216-071	■ VERDE/PASTEL GREEN 6019	x1	20	430	410	0,54	mc. 0,005

13 ABA-TELAIO SCHIENALE ESTERNO PORTANTE IN PLASTICA							
ABA-FRAME BACK IN PLASTIC FOR MESH							
CODICE/CODE	FINITURA/FINISHING	Q. KIT	Q. MIN/PACK	A	B	KG. x1/WT.x1	VOL. x1/UNIT VOL.
132103-065	■ NERO/BLACK	x1	20	320	460	0,51	mc. 0,005

14 ABA-PANNELLO SCHIENALE IN PLASTICA DA TAPPEZZARE							
ABA-FRAME BACK IN PLASTIC FOR UPHOLSTERY							
CODICE/CODE	FINITURA/FINISHING	Q. KIT	Q. MIN/PACK	A	B	KG. x1/WT.x1	VOL. x1/UNIT VOL.
132103-064	■ NERO/BLACK	x1	25	250	420	0,37	mc. 0,0025

15 ABA-CORNICE SCHIENALE IN PLASTICA PER RETE							
ABA-FRAME BACK IN PLASTIC MESH							
CODICE/CODE	FINITURA/FINISHING	Q. KIT	Q. MIN/PACK	A	B	KG. x1/WT.x1	VOL. x1/UNIT VOL.
132103-063	■ NERO/BLACK	x1	25	250	420	0,25	mc. 0,0025

SWIVEL OPTIONS:

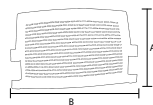
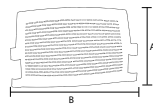
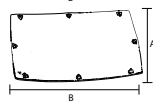
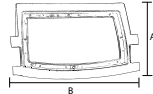

04 ABA-COPPIA BRACCIOLI DESTRO-SINISTRO PLASTICA ABA-PAIR ARM RIGHT-LEFT PLASTIC							
CODICE/CODE	FINITURA/FINISHING	Q. KIT	Q. MIN/PACK	A	KG. x1/WT.x1	VOL. x1/UNIT VOL.	
131702-055	■ ROSSO/RED 527	x1	20	190	0,21	mc. 0,002	
131703-055	■ NERO/BLACK	x1	20	190	0,21	mc. 0,002	
131704-055	■ GRIGIO/GRAY 7035	x1	20	190	0,21	mc. 0,002	
131705-055	□ BIANCO/WHITE 218	x1	20	190	0,21	mc. 0,002	
131714-055	■ VIOLA/VIOLET 145	x1	20	190	0,21	mc. 0,002	
131715-055	■ BLU/BLUE 5023	x1	20	190	0,21	mc. 0,002	
131716-055	■ VERDE/PASTEL GREEN 6019	x1	20	190	0,21	mc. 0,002	

13 ABA-TELAIO SCHIENALE ESTERNO PORTANTE IN PLASTICA ABA-FRAME BACK IN PLASTIC FOR MESH							
CODICE/CODE	FINITURA/FINISHING	Q. KIT	Q. MIN/PACK	A	B	KG. x1/WT.x1	VOL. x1/UNIT VOL.
132103-065	■ NERO/BLACK	x1	20	320	460	0,51	mc. 0,005

14 ABA-PANNELLO SCHIENALE IN PLASTICA DA TAPPEZZARE ABA-FRAME BACK IN PLASTIC FOR UPHOLSTERY							
CODICE/CODE	FINITURA/FINISHING	Q. KIT	Q. MIN/PACK	A	B	KG. x1/WT.x1	VOL. x1/UNIT VOL.
132103-064	■ NERO/BLACK	x1	25	250	420	0,37	mc. 0,0025

03 ABA-SCHIENALE PLASTICA COLORATO A VISTA ABA-PLASTIC BACK COLORED							
CODICE/CODE	FINITURA/FINISHING	Q. KIT	Q. MIN/PACK	A	B	KG. x1/WT.x1	VOL. x1/UNIT VOL.
132102-067	■ ROSSO/RED 527	x1	20	320	460	0,63	mc. 0,009
132103-067	■ NERO/BLACK	x1	20	320	460	0,63	mc. 0,009
132104-067	■ GRIGIO/GRAY 7035	x1	20	320	460	0,63	mc. 0,009
132105-067	□ BIANCO/WHITE 218	x1	20	320	460	0,63	mc. 0,009
132114-067	■ VIOLA/VIOLET 145	x1	20	320	460	0,63	mc. 0,009
132115-067	■ BLU/BLUE 5023	x1	20	320	460	0,63	mc. 0,009
132116-067	■ VERDE/PASTEL GREEN 6019	x1	20	320	460	0,63	mc. 0,009

04 ABA-COPPIA BRACCIOLI DESTRO-SINISTRO PLASTICA ABA-PAIR ARM RIGHT-LEFT PLASTIC							
CODICE/CODE	FINITURA/FINISHING	Q. KIT	Q. MIN/PACK	A	KG. x1/WT.x1	VOL. x1/UNIT VOL.	
131702-055	■ ROSSO/RED 527	x1	20	190	0,21	mc. 0,002	
131703-055	■ NERO/BLACK	x1	20	190	0,21	mc. 0,002	
131704-055	■ GRIGIO/GRAY 7035	x1	20	190	0,21	mc. 0,002	
131705-055	□ BIANCO/WHITE 218	x1	20	190	0,21	mc. 0,002	
131714-055	■ VIOLA/VIOLET 145	x1	20	190	0,21	mc. 0,002	
131715-055	■ BLU/BLUE 5023	x1	20	190	0,21	mc. 0,002	
131716-055	■ VERDE/PASTEL GREEN 6019	x1	20	190	0,21	mc. 0,002	

03 ABA-SCHIENALE PLASTICA COLORATO A VISTA ABA-PLASTIC BACK COLORED							
CODICE/CODE	FINITURA/FINISHING	Q. KIT	Q. MIN/PACK	A	B	KG. x1/WT.x1	VOL. x1/UNIT VOL.
132102-067	■ ROSSO/RED 527	x1	20	320	460	0,63	mc. 0,009
132103-067	■ NERO/BLACK	x1	20	320	460	0,63	mc. 0,009
132104-067	■ GRIGIO/GRAY 7035	x1	20	320	460	0,63	mc. 0,009
132105-067	□ BIANCO/WHITE 218	x1	20	320	460	0,63	mc. 0,009
132114-067	■ VIOLA/VIOLET 145	x1	20	320	460	0,63	mc. 0,009
132115-067	■ BLU/BLUE 5023	x1	20	320	460	0,63	mc. 0,009
132116-067	■ VERDE/PASTEL GREEN 6019	x1	20	320	460	0,63	mc. 0,009

05 ABA-COPPIA INSERTI SCHIENALE DESTRO-SINISTRO PLASTICA ABA-PAIR BACK INSERTS RIGHT-LEFT PLASTIC							
CODICE/CODE	FINITURA/FINISHING	Q. KIT	Q. MIN/PACK	KG. x1/WT.x1	VOL. x1/UNIT VOL.		
132102-066	■ ROSSO/RED 527	x1	50	50	mc. 0,009		
132103-066	■ NERO/BLACK	x1	50	50	mc. 0,009		
132104-066	■ GRIGIO/GRAY 7035	x1	50	50	mc. 0,009		
132105-066	□ BIANCO/WHITE 218	x1	50	50	mc. 0,009		
132114-066	■ VIOLA/VIOLET 145	x1	50	50	mc. 0,009		
132115-066	■ BLU/BLUE 5023	x1	50	50	mc. 0,009		
132116-066	■ VERDE/PASTEL GREEN 6019	x1	50	50	mc. 0,009		



PER I COMPONENTI DELLA PANCA VAI A PAG. 337
FOR THE BENCH COMPONENTS GO TO PAGE 337

20 ABA-TELAIO PER PANCA ABA-BENCH FRAME					
CODICE/CODE	FINITURA/FINISHING	Q. KIT	Q. MIN/PACK	KG. x1/WT.x1	VOL. x1/UNIT VOL.
110703-048	■ NERO/BLACK	x1	100	2,90	mc. 0,02

04 ABA-COPPIA BRACCIOLI DESTRO-SINISTRO PLASTICA ABA-PAIR ARM RIGHT-LEFT PLASTIC						
CODICE/CODE	FINITURA/FINISHING	Q. KIT	Q. MIN/PACK	A	KG. x1/WT.x1	VOL. x1/UNIT VOL.
131702-055	■ ROSSO/RED 527	x1	20	190	0,21	mc. 0,002
131703-055	■ NERO/BLACK	x1	20	190	0,21	mc. 0,002
131704-055	■ GRIGIO/GRAY 7035	x1	20	190	0,21	mc. 0,002
131705-055	□ BIANCO/WHITE 218	x1	20	190	0,21	mc. 0,002
131714-055	■ VIOLA/VIOLET 145	x1	20	190	0,21	mc. 0,002
131715-055	■ BLU/BLUE 5023	x1	20	190	0,21	mc. 0,002
131716-055	■ VERDE/PASTEL GREEN 6019	x1	20	190	0,21	mc. 0,002

05 ABA-COPPIA INSERTI SCHIENALE DESTRO-SINISTRO PLASTICA ABA-PAIR BACK INSERTS RIGHT-LEFT PLASTIC					
CODICE/CODE	FINITURA/FINISHING	Q. KIT	Q. MIN/PACK		
132102-066	■ ROSSO/RED 527	x1	50		
132103-066	■ NERO/BLACK	x1	50		
132104-066	■ GRIGIO/GRAY 7035	x1	50		
132105-066	□ BIANCO/WHITE 218	x1	50		
132114-066	■ VIOLA/VIOLET 145	x1	50		
132115-066	■ BLU/BLUE 5023	x1	50		
132116-066	■ VERDE/PASTEL GREEN 6019	x1	50		

06 ABA-SEDILE PLASTICA COLORATO A VISTA (TAPPEZZABILE) ABA-PLASTIC SEAT COLORED (TO BE UPHOLSTERED)							
CODICE/CODE	FINITURA/FINISHING	Q. KIT	Q. MIN/PACK	A	B	KG. x1/WT.x1	VOL. x1/UNIT VOL.
132202-070	■ ROSSO/RED 527	x1	10	455	470	1,32	mc. 0,01
132203-070	■ NERO/BLACK	x1	10	455	470	1,32	mc. 0,01
132204-070	■ GRIGIO/GRAY 7035	x1	10	455	470	1,32	mc. 0,01
132205-070	□ BIANCO/WHITE 218	x1	10	455	470	1,32	mc. 0,01
132214-070	■ VIOLA/VIOLET 145	x1	10	455	470	1,32	mc. 0,01
132215-070	■ BLU/BLUE 5023	x1	10	455	470	1,32	mc. 0,01
132216-070	■ VERDE/PASTEL GREEN 6019	x1	10	455	470	1,32	mc. 0,01

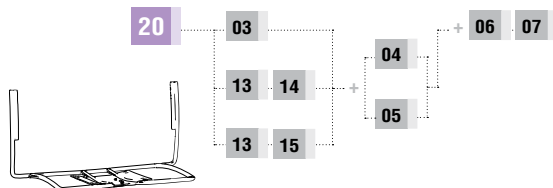

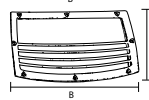
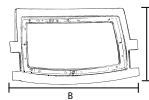

07 ABA-SOTTOSEDILE PLASTICA COLORATO A VISTA+VITI

ABA-OUTER PLASTIC SEAT COLORED+SCREWS

CODICE/CODE	FINITURA/FINISHING		Q. KIT	Q. MIN/PACK	A	B	KG. x1/WT.x1	VOL. x1/UNIT VOL.
132202-071	■ ROSSO/RED	527	x1	20	430	410	0,54	mc. 0,005
132203-071	■ NERO/BLACK		x1	20	430	410	0,54	mc. 0,005
132204-071	■ GRIGIO/GRAY	7035	x1	20	430	410	0,54	mc. 0,005
132205-071	□ BIANCO/WHITE	218	x1	20	430	410	0,54	mc. 0,005
132214-071	■ VIOLA/VIOLET	145	x1	20	430	410	0,54	mc. 0,005
132215-071	■ BLU/BLUE	5023	x1	20	430	410	0,54	mc. 0,005
132216-071	■ VERDE/PASTEL GREEN	6019	x1	20	430	410	0,54	mc. 0,005

13 ABA-TELAIO SCHIENALE ESTERNO PORTANTE IN PLASTICA

ABA-FRAME BACK IN PLASTIC FOR MESH

CODICE/CODE	FINITURA/FINISHING		Q. KIT	Q. MIN/PACK	A	B	KG. x1/WT.x1	VOL. x1/UNIT VOL.
132103-065	■ NERO/BLACK		x1	20	320	460	0,51	mc. 0,005

14 ABA-PANNELLO SCHIENALE IN PLASTICA DA TAPPEZZARE

ABA-FRAME BACK IN PLASTIC FOR UPHOLSTERY

CODICE/CODE	FINITURA/FINISHING		Q. KIT	Q. MIN/PACK	A	B	KG. x1/WT.x1	VOL. x1/UNIT VOL.
132103-064	■ NERO/BLACK		x1	25	250	420	0,37	mc. 0,0025

15 ABA-CORNICE SCHIENALE IN PLASTICA PER RETE

ABA-FRAME BACK IN PLASTIC MESH

CODICE/CODE	FINITURA/FINISHING		Q. KIT	Q. MIN/PACK	A	B	KG. x1/WT.x1	VOL. x1/UNIT VOL.
132103-063	■ NERO/BLACK		x1	25	250	420	0,25	mc. 0,0025

OPTIONAL GAMBA

LEG OPTIONAL





ALBA



X3



BIFMA

SLIDE

4 LEGS

SWIVEL

BENCH



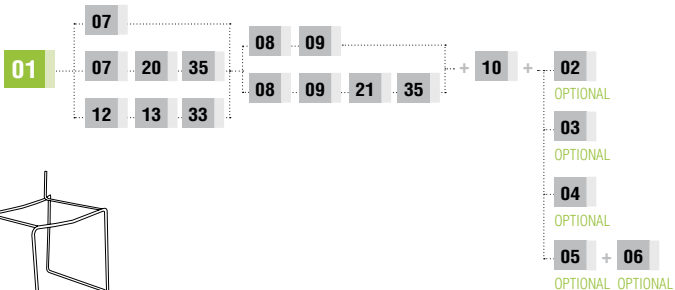
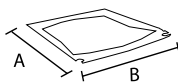
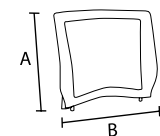
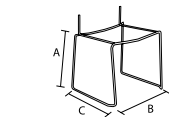
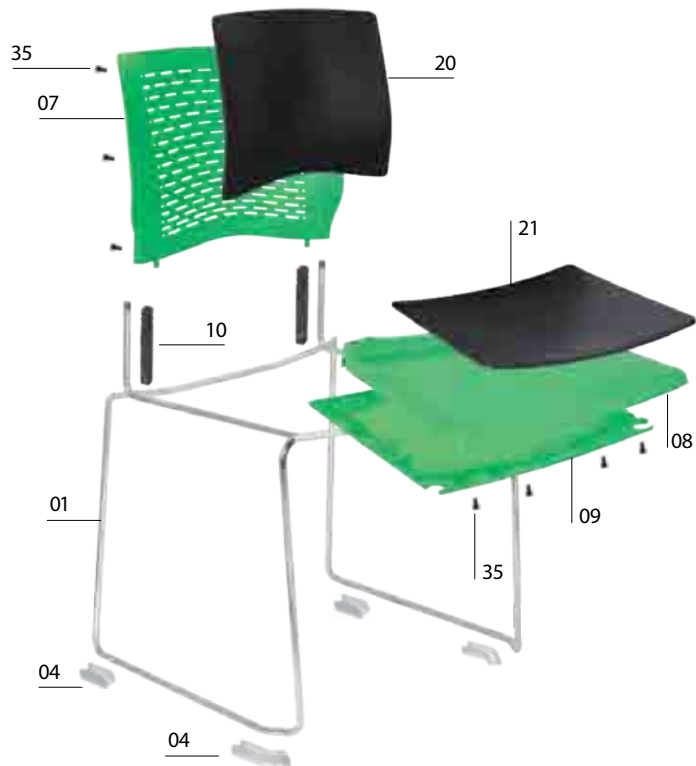

01 X3-TELAIO A SLITTA IN TONDINO D.12									
X3-SLIDE WIRE FRAME D.12									
CODICE/CODE	FINITURA/FINISHING	Q. KIT	Q. MIN/PACK	A	B	C	KG.x1/WT.x1	VOL.x1/UNIT VOL.	
113410-062	■ CROMATO/CHROME	x1	60	450	530	505	4,20	mc. 0,03	

02 BASE PIANA A PINZA IN PE PER TONDO									
CLIPS BASE FOR TUBE									
CODICE/CODE	FINITURA/FINISHING	Q. KIT							
134006-020	□ NEUTRO/NEUTRAL	x4							

03 BASE PIANA A PINZA DOPIA IN PE PER TONDO PER UNIONE SEDIE									
DOUBLE FLAT CLIP BASE FOR TUBE									
CODICE/CODE	FINITURA/FINISHING	Q. KIT							
134006-021	□ NEUTRO/NEUTRAL	x4							

04 BTF-KIT PIEDINI									
BTF-KIT FEET									
CODICE/CODE	FINITURA/FINISHING	Q. KIT	Q. MIN/PACK	KG.x1/WT.x1					
134306-001	□ NEUTRO/NEUTRAL	x1	100	0,05					

05 BTFA-KIT PIEDINI CON GANCI									
BTFA-KIT FEET WITH HOOKS									
CODICE/CODE	FINITURA/FINISHING	Q. KIT	Q. MIN/PACK	KG.x1/WT.x1					
134306-002	□ NEUTRO/NEUTRAL	x1	100	0,06					

06 PPTF-TAPPO PER FISSAGGIO PAVIMENTO									
PPTF-CAP FOR FIXING TO THE FLOOR									
CODICE/CODE	FINITURA/FINISHING	Q. KIT	Q. MIN/PACK	KG.x1/WT.x1					
134306-003	□ NEUTRO/NEUTRAL	x2	100	0,03					

07 X3-SCHIENALE COLORATO A VISTA IN PLASTICA									
X3-COLORED PLASTIC BACK									
CODICE/CODE	FINITURA/FINISHING	Q. KIT	Q. MIN/PACK	A	B	KG.x1/WT.x1	VOL.x1/UNIT VOL.		
132115-019	■ AZZURRO/BLUE RAL5014	x1	10	400	460	0,90	mc. 0,008		
132104-019	■ GRIGIO/GRAY RAL7003	x1	10	400	460	0,90	mc. 0,008		
132103-019	■ NERO/BLACK	x1	10	400	460	0,90	mc. 0,008		
132102-019	■ ROSSO/RED RAL527	x1	10	400	460	0,90	mc. 0,008		
132105-019	□ BIANCO/WHITE RAL1013	x1	10	400	460	0,90	mc. 0,008		
132116-019	■ VERDE/GREEN RAL6018	x1	10	400	460	0,90	mc. 0,008		

08 X3-SEDILE COLORATO A VISTA IN PLASTICA									
X3-COLORED PLASTIC SEAT									
CODICE/CODE	FINITURA/FINISHING	Q. KIT	Q. MIN/PACK	A	B	KG.x1/WT.x1	VOL.x1/UNIT VOL.		
132215-019	■ AZZURRO/BLUE RAL5014	x1	10	450	460	1,20	mc. 0,015		
132204-019	■ GRIGIO/GRAY RAL7003	x1	10	450	460	1,20	mc. 0,015		
132203-019	■ NERO/BLACK	x1	10	450	460	1,20	mc. 0,015		
132202-019	■ ROSSO/RED RAL527	x1	10	450	460	1,20	mc. 0,015		
132205-019	□ BIANCO/WHITE RAL1013	x1	10	450	460	1,20	mc. 0,015		
132216-019	■ VERDE/GREEN RAL6018	x1	10	450	460	1,20	mc. 0,015		

09 X3-SOTTOSEDILE COLORATO A VISTA IN PLASTICA									
X3-OUTER COLORED PLASTIC SEAT									
CODICE/CODE	FINITURA/FINISHING	Q. KIT	Q. MIN/PACK	A	B	KG.x1/WT.x1	VOL.x1/UNIT VOL.		
132215-009	■ AZZURRO/BLUE RAL5014	x1	20	450	460	0,73	mc. 0,007		
132204-009	■ GRIGIO/GRAY RAL7003	x1	20	450	460	0,73	mc. 0,007		
132203-009	■ NERO/BLACK	x1	20	450	460	0,73	mc. 0,007		
132202-009	■ ROSSO/RED RAL527	x1	20	450	460	0,73	mc. 0,007		
132205-009	□ BIANCO/WHITE RAL1013	x1	20	450	460	0,73	mc. 0,007		
132216-009	■ VERDE/GREEN RAL6018	x1	20	450	460	0,73	mc. 0,007		

10 X3-RIDUTTORE PER SCHIENALE IN PLASTICA									
X3-PLASTIC ADAPTER FOR THE BACK									
CODICE/CODE	FINITURA/FINISHING	Q. KIT	Q. MIN/PACK	KG.x1/WT.x1	VOL.x1/UNIT VOL.				
132103-009	■ NERO/BLACK	x2	200	0,019	mc. 0,0001				

35 VITE HILO TBL+ FR. D. 5X14 ZINCATO NERA (PER FISSARE PANNELLO SEDILE/SCHIENALE)									
SCREW TBL+FR.HILO D.5X14 ZINC.BLACK (TO FIX SEAT AND BACK PANEL)									
CODICE/CODE	FINITURA/FINISHING	Q. KIT SEDILE/NR.SEAT	Q. KIT SCHIENALE/NR.BACK						
117803-154	■ NERO/BLACK	x8	x6						

OPTIONAL 02
BASE PIANA A PINZA
CLIPS BASE



OPTIONAL 03
BASE PIANA A PINZA DOPIA
DOUBLE FLAT CLIP BASE



OPTIONAL 04
BTF-KIT PIEDINI
BTF-KIT FEET



OPTIONAL 05
BTFA-KIT PIEDINI CON GANCI
BTFA-KIT FEET WITH HOOKS



OPTIONAL 06
PPTF-TAPPO PER FISSAGGIO PAVIMENTO
PPTF-CAP FOR FIXING TO THE FLOOR



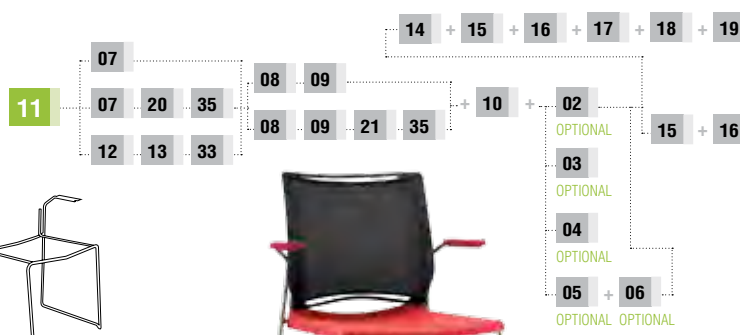
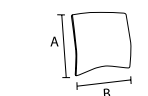
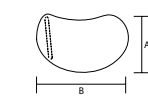
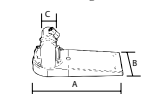
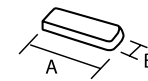
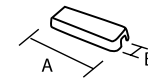
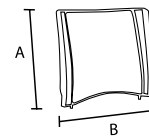
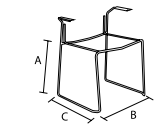
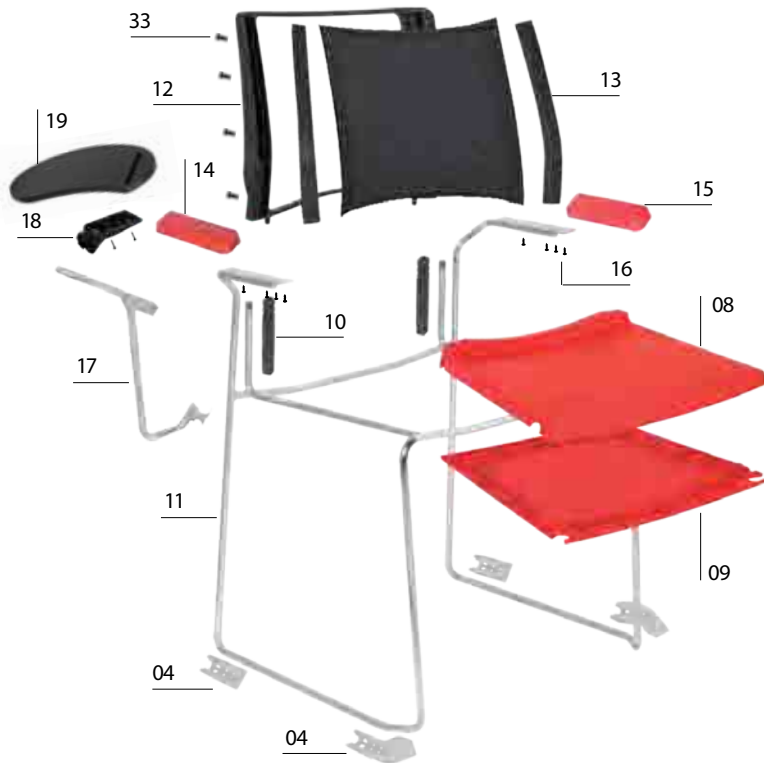

11 X3-TELAIO A SLITTA IN TONDINO D.12 CON BRACCIOLI									
X3-SLIDE WIRE FRAME D.12 WITH ARMS									
CODICE/CODE	FINITURA/FINISHING		Q.KIT	Q.MIN/PACK	A	B	C	KG.x1/WT.x1	VOL.x1/UNIT VOL.
113410-061	■ CROMATO/CHROME		x1	60	450	530	505	5,00	mc. 0,035

12 X3-SCHIENALE PER RETE COLORATO A VISTA IN PLASTICA									
X3-COLORED PLASTIC FOR MESH BACK									
CODICE/CODE	FINITURA/FINISHING		Q.KIT	Q.MIN/PACK	A	B		KG.x1/WT.x1	VOL.x1/UNIT VOL.
132115-014	■ AZZURRO/BLUE		x1	10	400	460		0,60	mc. 0,008
132104-014	■ GRIGIO/GRAY		x1	10	400	460		0,60	mc. 0,008
132103-014	■ NERO/BLACK		x1	10	400	460		0,60	mc. 0,008
132102-014	■ ROSSO/RED		x1	10	400	460		0,60	mc. 0,008
132105-014	□ BIANCO/WHITE		x1	10	400	460		0,60	mc. 0,008
132116-014	■ VERDE/GREEN		x1	10	400	460		0,60	mc. 0,008

13 X3-LISTE A+B PER SCHIENALE RETE COLORATE A VISTA									
X3-COLORED PLASTIC STRIPS A+B FOR MESH BACK									
CODICE/CODE	FINITURA/FINISHING		Q.KIT	Q.MIN/PACK				KG.x1/WT.x1	VOL.x1/UNIT VOL.
132115-013	■ AZZURRO/BLUE		x1	100				0,21	mc. 0,0004
132104-013	■ GRIGIO/GRAY		x1	100				0,21	mc. 0,0004
132103-013	■ NERO/BLACK		x1	100				0,21	mc. 0,0004
132102-013	■ ROSSO/RED		x1	100				0,21	mc. 0,0004
132105-018	□ BIANCO/WHITE		x1	100				0,21	mc. 0,0004
132116-013	■ VERDE/GREEN		x1	100				0,21	mc. 0,0004

14 X3-BRACCIOLO PLASTICA COLORATO PER TELAIO FILO CON TAVOLETTA									
X3-COLORED PLASTIC ARM FOR WIRE FRAME WITH TABLET									
CODICE/CODE	FINITURA/FINISHING		Q.KIT	Q.MIN/PACK	A	B		KG.x1/WT.x1	VOL.x1/UNIT VOL.
131715-018	■ AZZURRO/BLUE		x2	40	175	55		0,10	mc. 0,0004
131704-018	■ GRIGIO/GRAY		x2	40	175	55		0,10	mc. 0,0004
131703-018	■ NERO/BLACK		x2	40	175	55		0,10	mc. 0,0004
131702-018	■ ROSSO/RED		x2	40	175	55		0,10	mc. 0,0004
131705-018	□ BIANCO/WHITE		x2	40	175	55		0,10	mc. 0,0004
131716-018	■ VERDE/GREEN		x2	40	175	55		0,10	mc. 0,0004

15 X3-BRACCIOLO PLASTICA COLORATO PER TELAIO FILO									
X3-COLORED PLASTIC ARM FOR WIRE FRAME									
CODICE/CODE	FINITURA/FINISHING		Q.KIT	Q.MIN/PACK	A	B		KG.x1/WT.x1	VOL.x1/UNIT VOL.
131715-019	■ AZZURRO/BLUE		x2	40	175	55		0,10	mc. 0,0004
131704-019	■ GRIGIO/GRAY		x2	40	175	55		0,10	mc. 0,0004
131703-019	■ NERO/BLACK		x2	40	175	55		0,10	mc. 0,0004
131702-019	■ ROSSO/RED		x2	40	175	55		0,10	mc. 0,0004
131705-019	□ BIANCO/WHITE		x2	40	175	55		0,10	mc. 0,0004
131716-019	■ VERDE/GREEN		x2	40	175	55		0,10	mc. 0,0004

16 VITE HILO TBL+ FR. D.5X12 ZINCATA NERA(PER FISSARE BRACCIOLO TONDINO)									
SCREW TBL+FR.HILO D.5X12 ZINC.BLACK(TO FIX WIRE ARMS)									
CODICE/CODE	FINITURA/FINISHING		Q.KIT						
117803-154	■ NERO/BLACK		x8						

17 X3-SUPPORTO TAVOLETTA PER SLITTA + VITI									
X3-TABLET SUPPORT FOR SLIDE WIRE FRAME D.12 + SCREWS									
CODICE/CODE	FINITURA/FINISHING		Q.KIT	Q.MIN/PACK	A			KG.x1/WT.x1	VOL.x1/UNIT VOL.
111703-044	■ NERO/BLACK		x1	10	15x15			0,60	mc. 0,002
111703-047	■ NERO/BLACK		x1	10	15x15			0,60	mc. 0,002
111710-044	■ CROMATO/CHROME		x1	10	15x15			0,60	mc. 0,002
111710-047	■ CROMATO/CHROME		x1	10	15x15			0,60	mc. 0,002

18 SPT2-SNODO PER TAVOLETTA IN PLASTICA									
SPT2-MECHANISM FOR WRITING TABLET IN PLASTIC									
CODICE/CODE	FINITURA/FINISHING		Q.KIT	Q.MIN/PACK	A	B	C	KG.x1/WT.x1	VOL.x1/UNIT VOL.
134003-039	■ NERO/BLACK		x1	20	180	66	15x15	0,35	mc. 0,0006

19 BEAN-TAVOLETTA IN PLASTICA SPESSORE 16									
BEAN-WRITING TABLET IN PLASTIC THICKNESS 16 MM									
CODICE/CODE	FINITURA/FINISHING		Q.KIT	Q.MIN/PACK	A	B		KG.x1/WT.x1	VOL.x1/UNIT VOL.
134003-044	■ NERO/BLACK		x1	20	235	370		0,40	mc. 0,002

20 X3-PANNELLO SCHIENALE DA TAPPEZZARE IN PLASTICA									
X3-BACK PANEL FOR UPHOLSTERY									
CODICE/CODE	FINITURA/FINISHING		Q.KIT	Q.MIN/PACK	A	B		KG.x1/WT.x1	VOL.x1/UNIT VOL.
132103-008	■ NERO/BLACK		x1	20	350	385		0,50	mc. 0,003

21 X3-PANNELLO SEDILE DA TAPPEZZARE IN PLASTICA									
X3-SEAT PANEL FOR UPHOLSTERY									
CODICE/CODE	FINITURA/FINISHING		Q.KIT	Q.MIN/PACK	A	B		KG.x1/WT.x1	VOL.x1/UNIT VOL.
132203-003	■ NERO/BLACK		x1	20	400	410		0,60	mc. 0,003

33 VITE TRUCCIOLARE TSP+ D.3,5X10 BRUNITA NERA(PER FISSARE SCHIENALE RETE)									
SHAVING SCREW TSP+ D.3,5X10 ZINC.(TO FIX MESH BACK)									
CODICE/CODE	FINITURA/FINISHING		Q.KIT						
117803-105	■ NERO/BLACK		x8						

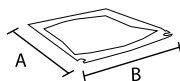
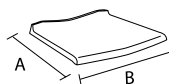
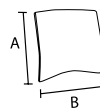
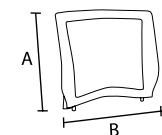

07 X3-SCHIENALE COLORATO A VISTA IN PLASTICA

X3-COLORED PLASTIC BACK									
CODICE/CODE	FINITURA/FINISHING		Q. KIT	Q. MIN/PACK	A	B	KG. x1/WT.x1	VOL. x1/UNIT VOL.	
132115-019	■ AZZURRO/BLUE	RAL5014	x1	10	400	460	0,90	mc. 0,008	
132104-019	■ GRIGIO/GRAY	RAL7003	x1	10	400	460	0,90	mc. 0,008	
132103-019	■ NERO/BLACK		x1	10	400	460	0,90	mc. 0,008	
132102-019	■ ROSSO/RED	RAL527	x1	10	400	460	0,90	mc. 0,008	
132105-019	□ BIANCO/WHITE	RAL1013	x1	10	400	460	0,90	mc. 0,008	
132116-019	■ VERDE/GREEN	RAL6018	x1	10	400	460	0,90	mc. 0,008	

20 X3-PANNELLO SCHIENALE DA TAPPEZZARE IN PLASTICA

X3-BACK PANEL FOR UPHOLSTERY									
CODICE/CODE	FINITURA/FINISHING		Q. KIT	Q. MIN/PACK	A	B	KG. x1/WT.x1	VOL. x1/UNIT VOL.	
132103-008	■ NERO/BLACK		x1	20	350	385	0,50	mc. 0,003	

08 X3-SEDILE COLORATO A VISTA IN PLASTICA

X3-COLORED PLASTIC SEAT									
CODICE/CODE	FINITURA/FINISHING		Q. KIT	Q. MIN/PACK	A	B	KG. x1/WT.x1	VOL. x1/UNIT VOL.	
132215-019	■ AZZURRO/BLUE	RAL5014	x1	10	450	460	1,20	mc. 0,015	
132204-019	■ GRIGIO/GRAY	RAL7003	x1	10	450	460	1,20	mc. 0,015	
132203-019	■ NERO/BLACK		x1	10	450	460	1,20	mc. 0,015	
132202-019	■ ROSSO/RED	RAL527	x1	10	450	460	1,20	mc. 0,015	
132205-019	□ BIANCO/WHITE	RAL1013	x1	10	450	460	1,20	mc. 0,015	
132216-019	■ VERDE/GREEN	RAL6018	x1	10	450	460	1,20	mc. 0,015	

09 X3-SOTTOSEDILE COLORATO A VISTA IN PLASTICA

X3-OUTER COLORED PLASTIC SEAT									
CODICE/CODE	FINITURA/FINISHING		Q. KIT	Q. MIN/PACK	A	B	KG. x1/WT.x1	VOL. x1/UNIT VOL.	
132215-009	■ AZZURRO/BLUE	RAL5014	x1	20	450	460	0,73	mc. 0,007	
132204-009	■ GRIGIO/GRAY	RAL7003	x1	20	450	460	0,73	mc. 0,007	
132203-009	■ NERO/BLACK		x1	20	450	460	0,73	mc. 0,007	
132202-009	■ ROSSO/RED	RAL527	x1	20	450	460	0,73	mc. 0,007	
132205-009	□ BIANCO/WHITE	RAL1013	x1	20	450	460	0,73	mc. 0,007	
132216-009	■ VERDE/GREEN	RAL6018	x1	20	450	460	0,73	mc. 0,007	

21 X3-PANNELLO SEDILE DA TAPPEZZARE IN PLASTICA

X3-SEAT PANEL FOR UPHOLSTERY									
CODICE/CODE	FINITURA/FINISHING		Q. KIT	Q. MIN/PACK	A	B	KG. x1/WT.x1	VOL. x1/UNIT VOL.	
132203-003	■ NERO/BLACK		x1	20	400	410	0,60	mc. 0,003	

+ 35 VITI / SCREWS

08 X3-SEDILE COLORATO A VISTA IN PLASTICA

X3-COLORED PLASTIC SEAT									
CODICE/CODE	FINITURA/FINISHING		Q. KIT	Q. MIN/PACK	A	B	KG. x1/WT.x1	VOL. x1/UNIT VOL.	
132215-019	■ AZZURRO/BLUE	RAL5014	x1	10	450	460	1,20	mc. 0,015	
132204-019	■ GRIGIO/GRAY	RAL7003	x1	10	450	460	1,20	mc. 0,015	
132203-019	■ NERO/BLACK		x1	10	450	460	1,20	mc. 0,015	
132202-019	■ ROSSO/RED	RAL527	x1	10	450	460	1,20	mc. 0,015	
132205-019	□ BIANCO/WHITE	RAL1013	x1	10	450	460	1,20	mc. 0,015	
132216-019	■ VERDE/GREEN	RAL6018	x1	10	450	460	1,20	mc. 0,015	

09 X3-SOTTOSEDILE COLORATO A VISTA IN PLASTICA

X3-OUTER COLORED PLASTIC SEAT									
CODICE/CODE	FINITURA/FINISHING		Q. KIT	Q. MIN/PACK	A	B	KG. x1/WT.x1	VOL. x1/UNIT VOL.	
132215-009	■ AZZURRO/BLUE	RAL5014	x1	20	450	460	0,73	mc. 0,007	
132204-009	■ GRIGIO/GRAY	RAL7003	x1	20	450	460	0,73	mc. 0,007	
132203-009	■ NERO/BLACK		x1	20	450	460	0,73	mc. 0,007	
132202-009	■ ROSSO/RED	RAL527	x1	20	450	460	0,73	mc. 0,007	
132205-009	□ BIANCO/WHITE	RAL1013	x1	20	450	460	0,73	mc. 0,007	
132216-009	■ VERDE/GREEN	RAL6018	x1	20	450	460	0,73	mc. 0,007	

21 X3-PANNELLO SEDILE DA TAPPEZZARE IN PLASTICA

X3-SEAT PANEL FOR UPHOLSTERY									
CODICE/CODE	FINITURA/FINISHING		Q. KIT	Q. MIN/PACK	A	B	KG. x1/WT.x1	VOL. x1/UNIT VOL.	
132203-003	■ NERO/BLACK		x1	20	400	410	0,60	mc. 0,003	

+ 33 + 35 VITI / SCREWS

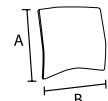
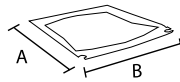
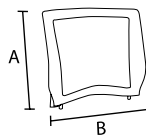
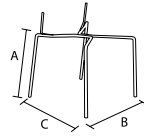

22 X3-TELAIO 4 GAMBE D.18									
X3-4 LEGS FRAME D.18									
CODICE/CODE	FINITURA/FINISHING	Q. KIT	Q. MIN/PACK	A	B	C	KG.x1/WT.x1	VOL.x1/UNIT VOL.	
112703-050	■ NERO/BLACK	x1	60	455	465	550	2,20	mc. 0,03	
112704-050	■ GRIGIO/GRAY	x1	60	455	465	550	2,20	mc. 0,03	
112710-050	■ CROMATO/CHROME	x1	60	455	465	550	2,20	mc. 0,03	

24 PUNTALE ALETTATO TONDO D.18 NERO									
INNER CAP FOR LEGS D.18 BLACK									
CODICE/CODE	FINITURA/FINISHING	Q. KIT							
134203-180	■ NERO/BLACK	x4							

07 X3-SCHIENALE COLORATO A VISTA IN PLASTICA									
X3-COLORED PLASTIC BACK									
CODICE/CODE	FINITURA/FINISHING	Q. KIT	Q. MIN/PACK	A	B	KG.x1/WT.x1	VOL.x1/UNIT VOL.		
132115-019	■ AZZURRO/BLUE	x1	10	400	460	0,90	mc. 0,008		
132104-019	■ GRIGIO/GRAY	x1	10	400	460	0,90	mc. 0,008		
132103-019	■ NERO/BLACK	x1	10	400	460	0,90	mc. 0,008		
132102-019	■ ROSSO/RED	x1	10	400	460	0,90	mc. 0,008		
132105-019	□ BIANCO/WHITE	x1	10	400	460	0,90	mc. 0,008		
132116-019	■ VERDE/GREEN	x1	10	400	460	0,90	mc. 0,008		

08 X3-SEDILE COLORATO A VISTA IN PLASTICA									
X3-COLORED PLASTIC SEAT									
CODICE/CODE	FINITURA/FINISHING	Q. KIT	Q. MIN/PACK	A	B	KG.x1/WT.x1	VOL.x1/UNIT VOL.		
132215-019	■ AZZURRO/BLUE	x1	10	450	460	1,20	mc. 0,015		
132204-019	■ GRIGIO/GRAY	x1	10	450	460	1,20	mc. 0,015		
132203-019	■ NERO/BLACK	x1	10	450	460	1,20	mc. 0,015		
132202-019	■ ROSSO/RED	x1	10	450	460	1,20	mc. 0,015		
132205-019	□ BIANCO/WHITE	x1	10	450	460	1,20	mc. 0,015		
132216-019	■ VERDE/GREEN	x1	10	450	460	1,20	mc. 0,015		

09 X3-SOTTOSEDILE COLORATO A VISTA IN PLASTICA									
X3-OUTER COLORED PLASTIC SEAT									
CODICE/CODE	FINITURA/FINISHING	Q. KIT	Q. MIN/PACK	A	B	KG.x1/WT.x1	VOL.x1/UNIT VOL.		
132215-009	■ AZZURRO/BLUE	x1	20	450	460	0,73	mc. 0,007		
132204-009	■ GRIGIO/GRAY	x1	20	450	460	0,73	mc. 0,007		
132203-009	■ NERO/BLACK	x1	20	450	460	0,73	mc. 0,007		
132202-009	■ ROSSO/RED	x1	20	450	460	0,73	mc. 0,007		
132205-009	□ BIANCO/WHITE	x1	20	450	460	0,73	mc. 0,007		
132216-009	■ VERDE/GREEN	x1	20	450	460	0,73	mc. 0,007		

10 X3-RIDUTTORE PER SCHIENALE IN PLASTICA									
X3-PLASTIC ADAPTER FOR THE BACK									
CODICE/CODE	FINITURA/FINISHING	Q. KIT	Q. MIN/PACK	KG.x1/WT.x1	VOL.x1/UNIT VOL.				
132103-009	■ NERO/BLACK	x2	200	0,019	mc. 0,0001				

20 X3-PANNELLO SCHIENALE DA TAPPEZZARE IN PLASTICA									
X3-BACK PANEL FOR UPHOLSTERY									
CODICE/CODE	FINITURA/FINISHING	Q. KIT	Q. MIN/PACK	A	B	KG.x1/WT.x1	VOL.x1/UNIT VOL.		
132103-008	■ NERO/BLACK	x1	20	350	385	0,50	mc. 0,003		

21 X3-PANNELLO SEDILE DA TAPPEZZARE IN PLASTICA									
X3-SEAT PANEL FOR UPHOLSTERY									
CODICE/CODE	FINITURA/FINISHING	Q. KIT	Q. MIN/PACK	A	B	KG.x1/WT.x1	VOL.x1/UNIT VOL.		
132203-003	■ NERO/BLACK	x1	20	400	410	0,60	mc. 0,003		

35 VITE HILO TBL+ FR. D.5X14 ZINCATA NERA (PER FISSARE PANNELLO SEDILE/SCHIENALE)									
SCREW TBL+FR.HILO D.5X14 ZINC.BLACK (TO FIX SEAT AND BACK PANEL)									
CODICE/CODE	FINITURA/FINISHING	Q. KIT SEDILE/NR.SEAT	Q. KIT SCHIENALE/NR.BACK						
117803-154	■ NERO/BLACK	x8	x6						

X3-CARRELLO PORTASEDIE CON ACCESSORI									
X3-TROLLEY FOR CHAIRS WITH ACCESSORIES									
CODICE/CODE	FINITURA/FINISHING	Q. KIT	KG.x1/WT.x1						
112703-010	■ NERO/BLACK	x1	10,50						

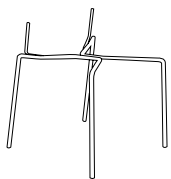
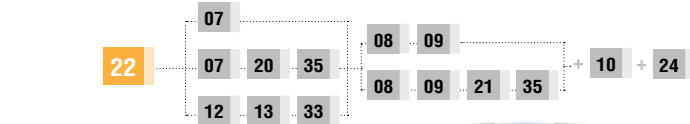

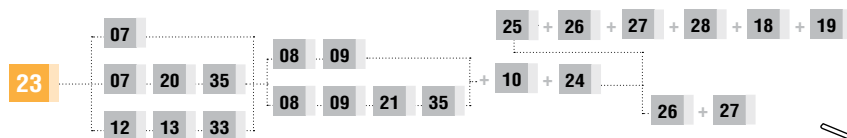
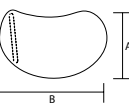
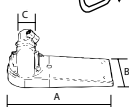
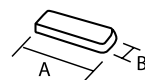
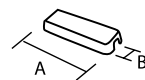
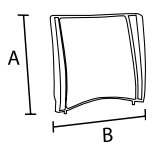
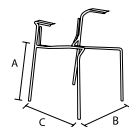
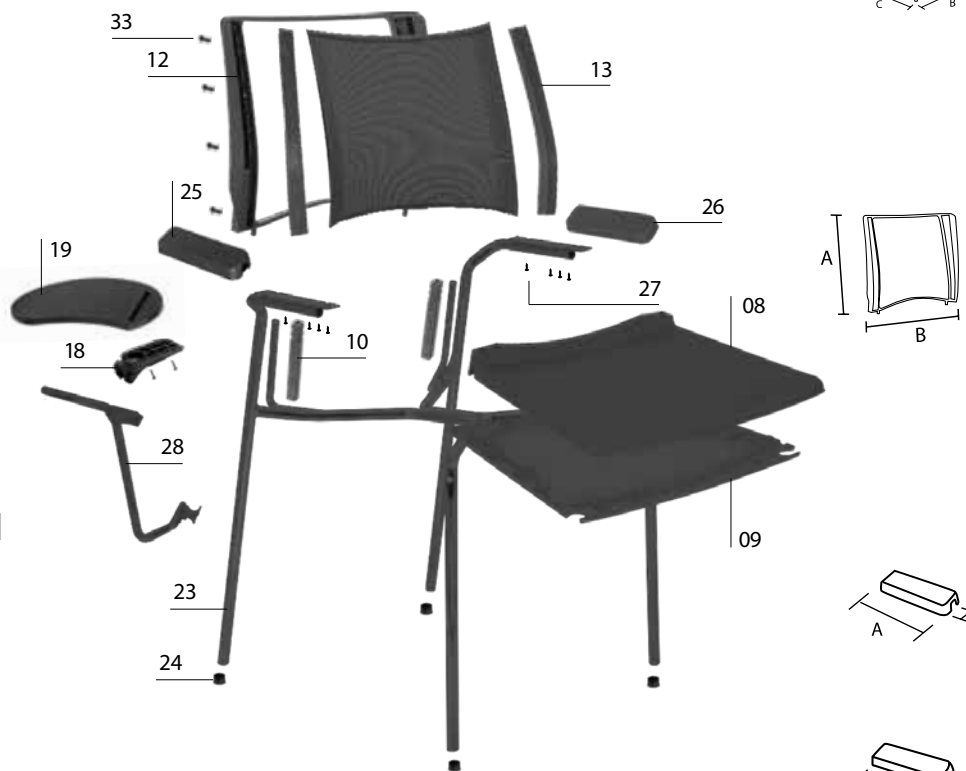

23 X3-TELAIO 4 GAMBE D.18 CON BRACCIOLI

X3-4 LEGS FRAME D.18 WITH ARMS

CODICE/CODE	FINITURA/FINISHING	Q.KIT	Q.MIN/PACK	A	B	C	KG.x1/WT.x1	VOL.x1/UNIT.VOL.
112703-051	■ NERO/BLACK	x1	60	455	465	550	2,80	mc. 0,035
112704-051	■ GRIGIO/GRAY	x1	60	455	465	550	2,80	mc. 0,035
112710-054	■ CROMATO/CHROME	x1	60	455	465	550	2,80	mc. 0,035

24 PUNTALE ALETTATO TONDO D.18 NERO

INNER CAP FOR LEGS D.18 BLACK

CODICE/CODE	FINITURA/FINISHING	Q.KIT
134203-180	■ NERO/BLACK	x4

10 X3-RIDUTTORE PER SCHIENALE IN PLASTICA

X3-PLASTIC ADAPTER FOR THE BACK

CODICE/CODE	FINITURA/FINISHING	Q.KIT	Q.MIN/PACK	KG.x1/WT.x1	VOL.x1/UNIT.VOL.
132103-009	■ NERO/BLACK	x2	200	0,019	mc. 0,0001

12 X3-SCHIENALE PER RETE COLORATO A VISTA IN PLASTICA

X3-COLORED PLASTIC FOR MESH BACK

CODICE/CODE	FINITURA/FINISHING	Q.KIT	Q.MIN/PACK	A	B	KG.x1/WT.x1	VOL.x1/UNIT.VOL.
132115-014	■ AZZURRO/BLUE RAL5014	x1	10	400	460	0,60	mc. 0,008
132104-014	■ GRIGIO/GRAY RAL7003	x1	10	400	460	0,60	mc. 0,008
132103-014	■ NERO/BLACK	x1	10	400	460	0,60	mc. 0,008
132102-014	■ ROSSO/RED RAL527	x1	10	400	460	0,60	mc. 0,008
132105-014	□ BIANCO/WHITE RAL1013	x1	10	400	460	0,60	mc. 0,008
132116-014	■ VERDE/GREEN RAL6018	x1	10	400	460	0,60	mc. 0,008

13 X3-LISTE A+B PER SCHIENALE RETE COLORATE A VISTA

X3-COLORED PLASTIC STRIPS A+B FOR MESH BACK

CODICE/CODE	FINITURA/FINISHING	Q.KIT	Q.MIN/PACK	KG.x1/WT.x1	VOL.x1/UNIT.VOL.
132115-013	■ AZZURRO/BLUE RAL5014	x1	100	0,21	mc. 0,0004
132104-013	■ GRIGIO/GRAY RAL7003	x1	100	0,21	mc. 0,0004
132103-013	■ NERO/BLACK	x1	100	0,21	mc. 0,0004
132102-013	■ ROSSO/RED RAL527	x1	100	0,21	mc. 0,0004
132105-018	□ BIANCO/WHITE RAL1013	x1	100	0,21	mc. 0,0004
132116-013	■ VERDE/GREEN RAL6018	x1	100	0,21	mc. 0,0004

25 X3-BRACCIOLO PLASTICA COLORATO PER TELAIO 4 GAMBE CON TAVOLETTA

X3-COLORED PLASTIC ARM FOR 4 LEGS FRAME WITH TABLET

CODICE/CODE	FINITURA/FINISHING	Q.KIT	Q.MIN/PACK	A	B	KG.x1/WT.x1	VOL.x1/UNIT.VOL.
131715-014	■ AZZURRO/BLUE RAL5014	x2	40	175	55	0,10	mc. 0,0004
131704-014	■ GRIGIO/GRAY RAL7003	x2	40	175	55	0,10	mc. 0,0004
131703-014	■ NERO/BLACK	x2	40	175	55	0,10	mc. 0,0004
131702-014	■ ROSSO/RED RAL527	x2	40	175	55	0,10	mc. 0,0004
131705-014	□ BIANCO/WHITE RAL1013	x2	40	175	55	0,10	mc. 0,0004
131716-014	■ VERDE/GREEN RAL6018	x2	40	175	55	0,10	mc. 0,0004

26 X3-BRACCIOLO PLASTICA COLORATO PER TELAIO 4 GAMBE

X3-COLORED PLASTIC ARM FOR 4 LEGS FRAME

CODICE/CODE	FINITURA/FINISHING	Q.KIT	Q.MIN/PACK	A	B	KG.x1/WT.x1	VOL.x1/UNIT.VOL.
131715-017	■ AZZURRO/BLUE RAL5014	x2	40	175	55	0,10	mc. 0,0004
131704-017	■ GRIGIO/GRAY RAL7003	x2	40	175	55	0,10	mc. 0,0004
131703-017	■ NERO/BLACK	x2	40	175	55	0,10	mc. 0,0004
131702-017	■ ROSSO/RED RAL527	x2	40	175	55	0,10	mc. 0,0004
131705-017	□ BIANCO/WHITE RAL1013	x2	40	175	55	0,10	mc. 0,0004
131716-017	■ VERDE/GREEN RAL6018	x2	40	175	55	0,10	mc. 0,0004

27 VITE HILO TBL+ FR. D.5X14 ZINCATA NERA (PER FISSARE BRACCIOLO IN TUBO)

SCREW TBL+FR.HILO D.5X14 ZINC.BLACK (TO FIX TUBE ARMS)

CODICE/CODE	FINITURA/FINISHING	Q.KIT
117803-156	■ NERO/BLACK	x8

28 X3-SUPPORTO TAVOLETTA PER 4 GAMBE + VITI

X3-TABLET SUPPORT FOR 4 LEGS FRAME + SCREWS

CODICE/CODE	FINITURA/FINISHING	Q.KIT	Q.MIN/PACK	A	KG.x1/WT.x1	VOL.x1/UNIT.VOL.
111703-043	■ NERO/BLACK DESTRO/RIGHT - 4 gambe/legs	x1	10	15x15	0,60	mc. 0,002
111703-046	■ NERO/BLACK SINISTRO/LEFT - 4 gambe/legs	x1	10	15x15	0,60	mc. 0,002
111710-037	■ CROMATO/CHROME DESTRO/RIGHT - 4 gambe/legs	x1	10	15x15	0,60	mc. 0,002
111710-039	■ CROMATO/CHROME SINISTRO/LEFT - 4 gambe/legs	x1	10	15x15	0,60	mc. 0,002

18 SPT2-SNODO PER TAVOLETTA IN PLASTICA

SPT2-MECHANISM FOR WRITING TABLET IN PLASTIC

CODICE/CODE	FINITURA/FINISHING	Q.KIT	Q.MIN/PACK	A	B	C	KG.x1/WT.x1	VOL.x1/UNIT.VOL.
134003-039	■ NERO/BLACK	x1	20	180	66	15x15	0,35	mc. 0,0006

19 BEAN-TAVOLETTA IN PLASTICA SPESSORE 16

BEAN-WRITING TABLET IN PLASTIC THICKNESS 16 MM

CODICE/CODE	FINITURA/FINISHING	Q.KIT	Q.MIN/PACK	A	B	KG.x1/WT.x1	VOL.x1/UNIT.VOL.
134003-044	■ NERO/BLACK	x1	20	235	370	0,40	mc. 0,002

33 VITE TRUCCIOLARE TSP+ D.3,5X10 BRUNITA NERA(PER FISSARE SCHIENALE RETE)

SHAVING SCREW TSP+ D.3,5X10 ZINC.(TO FIX MESH BACK)

CODICE/CODE	FINITURA/FINISHING	Q.KIT
117803-105	■ NERO/BLACK	x8

4 LEGS OPTIONS:

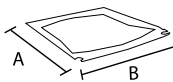
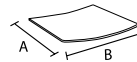
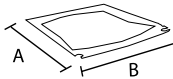
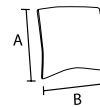
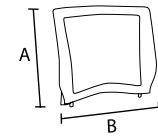

07 X3-SCHIENALE COLORATO A VISTA IN PLASTICA

CODICE/CODE	FINITURA/FINISHING	Q. KIT	Q. MIN/PACK	A	B	KG. x1/WT.x1	VOL. x1/UNIT VOL.
132115-019	■ AZZURRO/BLUE RAL5014	x1	10	400	460	0,90	mc. 0,008
132104-019	■ GRIGIO/GRAY RAL7003	x1	10	400	460	0,90	mc. 0,008
132103-019	■ NERO/BLACK	x1	10	400	460	0,90	mc. 0,008
132102-019	■ ROSSO/RED RAL527	x1	10	400	460	0,90	mc. 0,008
132105-019	□ BIANCO/WHITE RAL1013	x1	10	400	460	0,90	mc. 0,008
132116-019	■ VERDE/GREEN RAL6018	x1	10	400	460	0,90	mc. 0,008

20 X3-PANNELLO SCHIENALE DA TAPPEZZARE IN PLASTICA

CODICE/CODE	FINITURA/FINISHING	Q. KIT	Q. MIN/PACK	A	B	KG. x1/WT.x1	VOL. x1/UNIT VOL.
132103-008	■ NERO/BLACK	x1	20	350	385	0,50	mc. 0,003

08 X3-SEDILE COLORATO A VISTA IN PLASTICA

CODICE/CODE	FINITURA/FINISHING	Q. KIT	Q. MIN/PACK	A	B	KG. x1/WT.x1	VOL. x1/UNIT VOL.
132215-019	■ AZZURRO/BLUE RAL5014	x1	10	450	460	1,20	mc. 0,015
132204-019	■ GRIGIO/GRAY RAL7003	x1	10	450	460	1,20	mc. 0,015
132203-019	■ NERO/BLACK	x1	10	450	460	1,20	mc. 0,015
132202-019	■ ROSSO/RED RAL527	x1	10	450	460	1,20	mc. 0,015
132205-019	□ BIANCO/WHITE RAL1013	x1	10	450	460	1,20	mc. 0,015
132216-019	■ VERDE/GREEN RAL6018	x1	10	450	460	1,20	mc. 0,015

09 X3-SOTTOSEDILE COLORATO A VISTA IN PLASTICA

CODICE/CODE	FINITURA/FINISHING	Q. KIT	Q. MIN/PACK	A	B	KG. x1/WT.x1	VOL. x1/UNIT VOL.
132215-009	■ AZZURRO/BLUE RAL5014	x1	20	450	460	0,73	mc. 0,007
132204-009	■ GRIGIO/GRAY RAL7003	x1	20	450	460	0,73	mc. 0,007
132203-009	■ NERO/BLACK	x1	20	450	460	0,73	mc. 0,007
132202-009	■ ROSSO/RED RAL527	x1	20	450	460	0,73	mc. 0,007
132205-009	□ BIANCO/WHITE RAL1013	x1	20	450	460	0,73	mc. 0,007
132216-009	■ VERDE/GREEN RAL6018	x1	20	450	460	0,73	mc. 0,007

21 X3-PANNELLO SEDILE DA TAPPEZZARE IN PLASTICA

CODICE/CODE	FINITURA/FINISHING	Q. KIT	Q. MIN/PACK	A	B	KG. x1/WT.x1	VOL. x1/UNIT VOL.
132203-003	■ NERO/BLACK	x1	20	400	410	0,60	mc. 0,003

+ 35 VITI / SCREWS

08 X3-SEDILE COLORATO A VISTA IN PLASTICA

CODICE/CODE	FINITURA/FINISHING	Q. KIT	Q. MIN/PACK	A	B	KG. x1/WT.x1	VOL. x1/UNIT VOL.
132215-019	■ AZZURRO/BLUE RAL5014	x1	10	450	460	1,20	mc. 0,015
132204-019	■ GRIGIO/GRAY RAL7003	x1	10	450	460	1,20	mc. 0,015
132203-019	■ NERO/BLACK	x1	10	450	460	1,20	mc. 0,015
132202-019	■ ROSSO/RED RAL527	x1	10	450	460	1,20	mc. 0,015
132205-019	□ BIANCO/WHITE RAL1013	x1	10	450	460	1,20	mc. 0,015
132216-019	■ VERDE/GREEN RAL6018	x1	10	450	460	1,20	mc. 0,015

09 X3-SOTTOSEDILE COLORATO A VISTA IN PLASTICA

CODICE/CODE	FINITURA/FINISHING	Q. KIT	Q. MIN/PACK	A	B	KG. x1/WT.x1	VOL. x1/UNIT VOL.
132215-009	■ AZZURRO/BLUE RAL5014	x1	20	450	460	0,73	mc. 0,007
132204-009	■ GRIGIO/GRAY RAL7003	x1	20	450	460	0,73	mc. 0,007
132203-009	■ NERO/BLACK	x1	20	450	460	0,73	mc. 0,007
132202-009	■ ROSSO/RED RAL527	x1	20	450	460	0,73	mc. 0,007
132205-009	□ BIANCO/WHITE RAL1013	x1	20	450	460	0,73	mc. 0,007
132216-009	■ VERDE/GREEN RAL6018	x1	20	450	460	0,73	mc. 0,007

21 X3-PANNELLO SEDILE DA TAPPEZZARE IN PLASTICA

CODICE/CODE	FINITURA/FINISHING	Q. KIT	Q. MIN/PACK	A	B	KG. x1/WT.x1	VOL. x1/UNIT VOL.
132203-003	■ NERO/BLACK	x1	20	400	410	0,60	mc. 0,003

+ 35 VITI / SCREWS

OPTIONAL

TAVOLETTA TL1
TL1 TABLET



VEDI/SEE PAG. 327

TAVOLETTA TL2
TL2 TABLET



VEDI/SEE PAG. 327

TAVOLETTA TL3
TL3 TABLET



VEDI/SEE PAG. 327

TAVOLETTA BEAN
BEAN TABLET



VEDI/SEE PAG. 327

TAVOLETTA TL01
TL01 TABLET



VEDI/SEE PAG. 327

SNODO TAVOLETTA SPT2
SPT2 MECHANISM TABLET



VEDI/SEE PAG. 326

SNODO ANTIPANICO
MECHANISM ANTIPANIC



VEDI/SEE PAG. 326

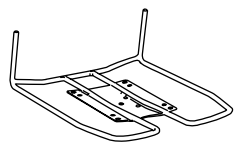
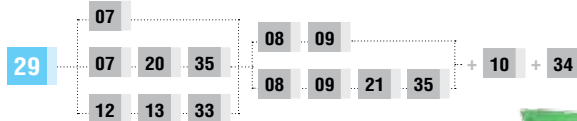
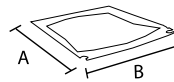
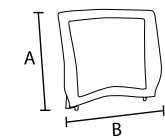
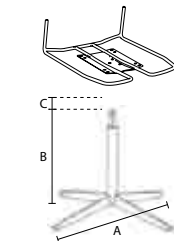

29 X3-TELAIO GIREVOLE A GAS X3-SWIVEL WIRE FRAME D.12						
CODICE/CODE	FINITURA/FINISHING	Q. KIT	Q. MIN/PACK	KG. x1/WT.x1	VOL. x1/UNIT VOL.	
110903-028	■ NERO/BLACK	x1	100	3,00	mc. 0,02	
110904-014	■ GRIGIO/GRAY	x1	100	3,00	mc. 0,02	

34 B20-BASE CON POMPA A GAS ASSEMBLATA B20-BASE WITH GAS PUMP ASSEMBLED								
CODICE/CODE	FINITURA/FINISHING	Q. KIT	Q. MIN/PACK	A	B	C	KG. x1/WT.x1	VOL. x1/UNIT VOL.
110210-080	■ CROMATO/CHROME	x1	50	700	325	75	4,80	mc. 0,03

07 X3-SCHIENALE COLORATO A VISTA IN PLASTICA X3-COLORED PLASTIC BACK							
CODICE/CODE	FINITURA/FINISHING	Q. KIT	Q. MIN/PACK	A	B	KG. x1/WT.x1	VOL. x1/UNIT VOL.
132115-019	■ AZZURRO/BLUE RAL5014	x1	10	400	460	0,90	mc. 0,008
132104-019	■ GRIGIO/GRAY RAL7003	x1	10	400	460	0,90	mc. 0,008
132103-019	■ NERO/BLACK	x1	10	400	460	0,90	mc. 0,008
132102-019	■ ROSSO/RED RAL527	x1	10	400	460	0,90	mc. 0,008
132105-019	□ BIANCO/WHITE RAL1013	x1	10	400	460	0,90	mc. 0,008
132116-019	■ VERDE/GREEN RAL6018	x1	10	400	460	0,90	mc. 0,008

08 X3-SEDILE COLORATO A VISTA IN PLASTICA X3-COLORED PLASTIC SEAT							
CODICE/CODE	FINITURA/FINISHING	Q. KIT	Q. MIN/PACK	A	B	KG. x1/WT.x1	VOL. x1/UNIT VOL.
132215-019	■ AZZURRO/BLUE RAL5014	x1	10	450	460	1,20	mc. 0,015
132204-019	■ GRIGIO/GRAY RAL7003	x1	10	450	460	1,20	mc. 0,015
132203-019	■ NERO/BLACK	x1	10	450	460	1,20	mc. 0,015
132202-019	■ ROSSO/RED RAL527	x1	10	450	460	1,20	mc. 0,015
132205-019	□ BIANCO/WHITE RAL1013	x1	10	450	460	1,20	mc. 0,015
132216-019	■ VERDE/GREEN RAL6018	x1	10	450	460	1,20	mc. 0,015

09 X3-SOTTOSEDILE COLORATO A VISTA IN PLASTICA X3-OUTER COLORED PLASTIC SEAT							
CODICE/CODE	FINITURA/FINISHING	Q. KIT	Q. MIN/PACK	A	B	KG. x1/WT.x1	VOL. x1/UNIT VOL.
132215-009	■ AZZURRO/BLUE RAL5014	x1	20	450	460	0,73	mc. 0,007
132204-009	■ GRIGIO/GRAY RAL7003	x1	20	450	460	0,73	mc. 0,007
132203-009	■ NERO/BLACK	x1	20	450	460	0,73	mc. 0,007
132202-009	■ ROSSO/RED RAL527	x1	20	450	460	0,73	mc. 0,007
132205-009	□ BIANCO/WHITE RAL1013	x1	20	450	460	0,73	mc. 0,007
132216-009	■ VERDE/GREEN RAL6018	x1	20	450	460	0,73	mc. 0,007

10 X3-RIDUTTORE PER SCHIENALE IN PLASTICA X3-PLASTIC ADAPTER FOR THE BACK						
CODICE/CODE	FINITURA/FINISHING	Q. KIT	Q. MIN/PACK	KG. x1/WT.x1	VOL. x1/UNIT VOL.	
132103-009	■ NERO/BLACK	x2	200	0,019	mc. 0,0001	

20 X3-PANNELLO SCHIENALE DA TAPPEZZARE IN PLASTICA X3-BACK PANEL FOR UPHOLSTERY							
CODICE/CODE	FINITURA/FINISHING	Q. KIT	Q. MIN/PACK	A	B	KG. x1/WT.x1	VOL. x1/UNIT VOL.
132103-008	■ NERO/BLACK	x1	20	350	385	0,50	mc. 0,003

21 X3-PANNELLO SEDILE DA TAPPEZZARE IN PLASTICA X3-SEAT PANEL FOR UPHOLSTERY							
CODICE/CODE	FINITURA/FINISHING	Q. KIT	Q. MIN/PACK	A	B	KG. x1/WT.x1	VOL. x1/UNIT VOL.
132203-003	■ NERO/BLACK	x1	20	400	410	0,60	mc. 0,003

35 VITE HILO TBL+ FR. D.5X14 ZINCATA NERA (PER FISSARE PANNELLO SEDILE/SCHIENALE) SCREW TBL+FR.HILO D.5X14 ZINC. BLACK (TO FIX SEAT AND BACK PANEL)						
CODICE/CODE	FINITURA/FINISHING	Q. KIT SEDILE/NR.SEAT	Q. KIT SCHIENALE/NR.BACK			
117803-154	■ NERO/BLACK	x8	x6			

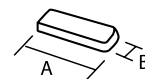
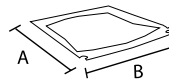
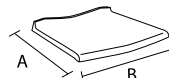
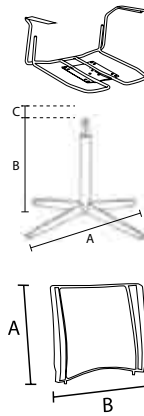

30 X3-TELAIO GIREVOLE A GAS CON BRACCIOLI X3-SWIVEL WIRE FRAME WITH ARMS D.12					
CODICE/CODE	FINITURA/FINISHING	Q. KIT	Q. MIN/PACK	KG. x1/WT.x1	VOL. x1/UNIT VOL.
110903-027	■ NERO/BLACK	x1	100	4,00	mc. 0,02
110904-015	■ GRIGIO/GRAY	x1	100	4,00	mc. 0,02
110910-015	■ CROMATO/CHROME	x1	100	4,00	mc. 0,02

34 B20-BASE CON POMPA A GAS ASSEMBLATA B20-BASE WITH GAS PUMP ASSEMBLED						
CODICE/CODE	FINITURA/FINISHING	Q. KIT	Q. MIN/PACK	A B C	KG. x1/WT.x1	VOL. x1/UNIT VOL.
110210-080	■ CROMATO/CHROME	x1	50	700 325 75	4,80	mc. 0,03

12 X3-SCHIENALE PER RETE COLORATO A VISTA IN PLASTICA X3-COLORED PLASTIC FOR MESH BACK						
CODICE/CODE	FINITURA/FINISHING	Q. KIT	Q. MIN/PACK	A B	KG. x1/WT.x1	VOL. x1/UNIT VOL.
132115-014	■ AZZURRO/BLUE RAL5014	x1	10	400 460	0,60	mc. 0,008
132104-014	■ GRIGIO/GRAY RAL7003	x1	10	400 460	0,60	mc. 0,008
132103-014	■ NERO/BLACK	x1	10	400 460	0,60	mc. 0,008
132102-014	■ ROSSO/RED RAL527	x1	10	400 460	0,60	mc. 0,008
132105-014	□ BIANCO/WHITE RAL1013	x1	10	400 460	0,60	mc. 0,008
132116-014	■ VERDE/GREEN RAL6018	x1	10	400 460	0,60	mc. 0,008

13 X3-LISTE A+B PER SCHIENALE RETE COLORATE A VISTA X3-COLORED PLASTIC STRIPS A+B FOR MESH BACK						
CODICE/CODE	FINITURA/FINISHING	Q. KIT	Q. MIN/PACK	A B	KG. x1/WT.x1	VOL. x1/UNIT VOL.
132115-013	■ AZZURRO/BLUE RAL5014	x1	100		0,21	mc. 0,0004
132104-013	■ GRIGIO/GRAY RAL7003	x1	100		0,21	mc. 0,0004
132103-013	■ NERO/BLACK	x1	100		0,21	mc. 0,0004
132102-013	■ ROSSO/RED RAL527	x1	100		0,21	mc. 0,0004
132105-013	□ BIANCO/WHITE RAL1013	x1	100		0,21	mc. 0,0004
132116-013	■ VERDE/GREEN RAL6018	x1	100		0,21	mc. 0,0004

08 X3-SEDILE COLORATO A VISTA IN PLASTICA X3-COLORED PLASTIC SEAT						
CODICE/CODE	FINITURA/FINISHING	Q. KIT	Q. MIN/PACK	A B	KG. x1/WT.x1	VOL. x1/UNIT VOL.
132215-019	■ AZZURRO/BLUE RAL5014	x1	10	450 460	1,20	mc. 0,015
132204-019	■ GRIGIO/GRAY RAL7003	x1	10	450 460	1,20	mc. 0,015
132203-019	■ NERO/BLACK	x1	10	450 460	1,20	mc. 0,015
132202-019	■ ROSSO/RED RAL527	x1	10	450 460	1,20	mc. 0,015
132205-019	□ BIANCO/WHITE RAL1013	x1	10	450 460	1,20	mc. 0,015
132216-019	■ VERDE/GREEN RAL6018	x1	10	450 460	1,20	mc. 0,015

09 X3-SOTTOSSEDILE COLORATO A VISTA IN PLASTICA X3-OUTER COLORED PLASTIC SEAT						
CODICE/CODE	FINITURA/FINISHING	Q. KIT	Q. MIN/PACK	A B	KG. x1/WT.x1	VOL. x1/UNIT VOL.
132215-009	■ AZZURRO/BLUE RAL5014	x1	20	450 460	0,73	mc. 0,007
132204-009	■ GRIGIO/GRAY RAL7003	x1	20	450 460	0,73	mc. 0,007
132203-009	■ NERO/BLACK	x1	20	450 460	0,73	mc. 0,007
132202-009	■ ROSSO/RED RAL527	x1	20	450 460	0,73	mc. 0,007
132205-009	□ BIANCO/WHITE RAL1013	x1	20	450 460	0,73	mc. 0,007
132216-009	■ VERDE/GREEN RAL6018	x1	20	450 460	0,73	mc. 0,007

10 X3-RIDUTTORE PER SCHIENALE IN PLASTICA X3-PLASTIC ADAPTER FOR THE BACK					
CODICE/CODE	FINITURA/FINISHING	Q. KIT	Q. MIN/PACK	KG. x1/WT.x1	VOL. x1/UNIT VOL.
132103-009	■ NERO/BLACK	x2	200	0,019	mc. 0,0001

15 X3-BRACCIOLO PLASTICA COLORATO PER TELAIO FILO X3-PLASTIC ARMS COLORED FOR WIRE FRAME						
CODICE/CODE	FINITURA/FINISHING	Q. KIT	Q. MIN/PACK	A B	KG. x1/WT.x1	VOL. x1/UNIT VOL.
131715-019	■ AZZURRO/BLUE RAL5014	x2	40	175 55	0,10	mc. 0,0004
131704-019	■ GRIGIO/GRAY RAL7003	x2	40	175 55	0,10	mc. 0,0004
131703-019	■ NERO/BLACK	x2	40	175 55	0,10	mc. 0,0004
131702-019	■ ROSSO/RED RAL527	x2	40	175 55	0,10	mc. 0,0004
131705-019	□ BIANCO/WHITE RAL1013	x2	40	175 55	0,10	mc. 0,0004
131716-019	■ VERDE/GREEN RAL6018	x2	40	175 55	0,10	mc. 0,0004

16 VITE HILO TBL+ FR. D. 5X12 ZINCATA NERA(PER FISSARE BRACCIOLO TONDINO) SCREW TBL+FR.HILO D.5X12 ZINC.BLACK(FOR FIX WIRE ARMS)					
CODICE/CODE	FINITURA/FINISHING	Q. KIT			
117803-154	■ NERO/BLACK	x8			

33 VITE TRUCCIOLARE TSP+ D. 3,5X10 BRUNITA NERA(PER FISSARE SCHIENALE RETE) SHAVING SCREW TSP+ D.3.5X10 ZINC.(TO FIX MESH BACK)					
CODICE/CODE	FINITURA/FINISHING	Q. KIT			
117803-105	■ NERO/BLACK	x8			

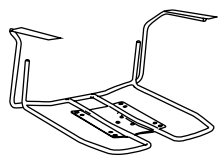
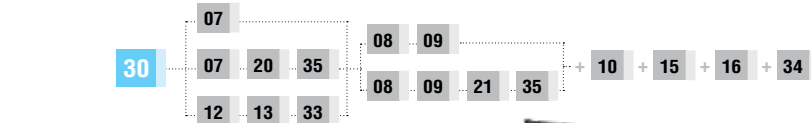

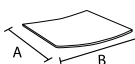
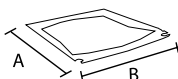
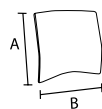
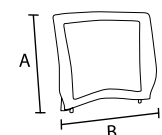

07 X3-SCHIENALE COLORATO A VISTA IN PLASTICA

X3-COLORED PLASTIC BACK									
CODICE/CODE	FINITURA/FINISHING		Q. KIT	Q. MIN/PACK	A	B	KG. x1/WT.x1	VOL. x1/UNIT VOL.	
132115-019	■ AZZURRO/BLUE RAL5014		x1	10	400	460	0,90	mc. 0,008	
132104-019	■ GRIGIO/GRAY RAL7003		x1	10	400	460	0,90	mc. 0,008	
132103-019	■ NERO/BLACK		x1	10	400	460	0,90	mc. 0,008	
132102-019	■ ROSSO/RED RAL527		x1	10	400	460	0,90	mc. 0,008	
132105-019	□ BIANCO/WHITE RAL1013		x1	10	400	460	0,90	mc. 0,008	
132116-019	■ VERDE/GREEN RAL6018		x1	10	400	460	0,90	mc. 0,008	

20 X3-PANNELLO SCHIENALE DA TAPPEZZARE IN PLASTICA

X3-BACK PANEL FOR UPHOLSTERY									
CODICE/CODE	FINITURA/FINISHING		Q. KIT	Q. MIN/PACK	A	B	KG. x1/WT.x1	VOL. x1/UNIT VOL.	
132103-008	■ NERO/BLACK		x1	20	350	385	0,50	mc. 0,003	

08 X3-SEDILE COLORATO A VISTA IN PLASTICA

X3-COLORED PLASTIC SEAT									
CODICE/CODE	FINITURA/FINISHING		Q. KIT	Q. MIN/PACK	A	B	KG. x1/WT.x1	VOL. x1/UNIT VOL.	
132215-019	■ AZZURRO/BLUE RAL5014		x1	10	450	460	1,20	mc. 0,015	
132204-019	■ GRIGIO/GRAY RAL7003		x1	10	450	460	1,20	mc. 0,015	
132203-019	■ NERO/BLACK		x1	10	450	460	1,20	mc. 0,015	
132202-019	■ ROSSO/RED RAL527		x1	10	450	460	1,20	mc. 0,015	
132205-019	□ BIANCO/WHITE RAL1013		x1	10	450	460	1,20	mc. 0,015	
132216-019	■ VERDE/GREEN RAL6018		x1	10	450	460	1,20	mc. 0,015	

09 X3-SOTTOSEDILE COLORATO A VISTA IN PLASTICA

X3-OUTER COLORED PLASTIC SEAT									
CODICE/CODE	FINITURA/FINISHING		Q. KIT	Q. MIN/PACK	A	B	KG. x1/WT.x1	VOL. x1/UNIT VOL.	
132215-009	■ AZZURRO/BLUE RAL5014		x1	20	450	460	0,73	mc. 0,007	
132204-009	■ GRIGIO/GRAY RAL7003		x1	20	450	460	0,73	mc. 0,007	
132203-009	■ NERO/BLACK		x1	20	450	460	0,73	mc. 0,007	
132202-009	■ ROSSO/RED RAL527		x1	20	450	460	0,73	mc. 0,007	
132205-009	□ BIANCO/WHITE RAL1013		x1	20	450	460	0,73	mc. 0,007	
132216-009	■ VERDE/GREEN RAL6018		x1	20	450	460	0,73	mc. 0,007	

21 X3-PANNELLO SEDILE DA TAPPEZZARE IN PLASTICA

X3-SEAT PANEL FOR UPHOLSTERY									
CODICE/CODE	FINITURA/FINISHING		Q. KIT	Q. MIN/PACK	A	B	KG. x1/WT.x1	VOL. x1/UNIT VOL.	
132203-003	■ NERO/BLACK		x1	20	400	410	0,60	mc. 0,003	

+ 35 VITI / SCREWS

08 X3-SEDILE COLORATO A VISTA IN PLASTICA

X3-COLORED PLASTIC SEAT									
CODICE/CODE	FINITURA/FINISHING		Q. KIT	Q. MIN/PACK	A	B	KG. x1/WT.x1	VOL. x1/UNIT VOL.	
132215-019	■ AZZURRO/BLUE RAL5014		x1	10	450	460	1,20	mc. 0,015	
132204-019	■ GRIGIO/GRAY RAL7003		x1	10	450	460	1,20	mc. 0,015	
132203-019	■ NERO/BLACK		x1	10	450	460	1,20	mc. 0,015	
132202-019	■ ROSSO/RED RAL527		x1	10	450	460	1,20	mc. 0,015	
132205-019	□ BIANCO/WHITE RAL1013		x1	10	450	460	1,20	mc. 0,015	
132216-019	■ VERDE/GREEN RAL6018		x1	10	450	460	1,20	mc. 0,015	

09 X3-SOTTOSEDILE COLORATO A VISTA IN PLASTICA

X3-OUTER COLORED PLASTIC SEAT									
CODICE/CODE	FINITURA/FINISHING		Q. KIT	Q. MIN/PACK	A	B	KG. x1/WT.x1	VOL. x1/UNIT VOL.	
132215-009	■ AZZURRO/BLUE RAL5014		x1	20	450	460	0,73	mc. 0,007	
132204-009	■ GRIGIO/GRAY RAL7003		x1	20	450	460	0,73	mc. 0,007	
132203-009	■ NERO/BLACK		x1	20	450	460	0,73	mc. 0,007	
132202-009	■ ROSSO/RED RAL527		x1	20	450	460	0,73	mc. 0,007	
132205-009	□ BIANCO/WHITE RAL1013		x1	20	450	460	0,73	mc. 0,007	
132216-009	■ VERDE/GREEN RAL6018		x1	20	450	460	0,73	mc. 0,007	

21 X3-PANNELLO SEDILE DA TAPPEZZARE IN PLASTICA

X3-SEAT PANEL FOR UPHOLSTERY									
CODICE/CODE	FINITURA/FINISHING		Q. KIT	Q. MIN/PACK	A	B	KG. x1/WT.x1	VOL. x1/UNIT VOL.	
132203-003	■ NERO/BLACK		x1	20	400	410	0,60	mc. 0,003	

+ 33 + 35 VITI / SCREWS



PER I COMPONENTI DELLA PANCA VAI A PAG. 337
FOR THE BENCH COMPONENTS GO TO PAGE 337

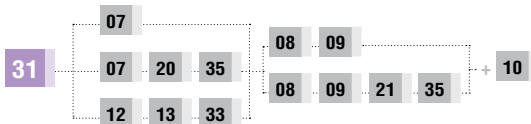
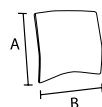
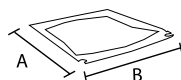
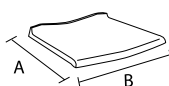
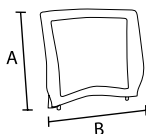

31 X3-TELAIO PER PANCA X3-BENCH WIRE FRAME D.12						
CODICE/CODE	FINITURA/FINISHING	Q. KIT	Q. MIN/PACK	KG. x1/WT.x1	VOL. x1/UNIT VOL.	
110703-041	■ NERO/BLACK	x1	100	2,70	mc. 0,02	
110704-039	■ GRIGIO/GRAY	x1	100	2,70	mc. 0,02	

07 X3-SCHIENALE COLORATO A VISTA IN PLASTICA X3-COLORED PLASTIC BACK							
CODICE/CODE	FINITURA/FINISHING	Q. KIT	Q. MIN/PACK	A	B	KG. x1/WT.x1	VOL. x1/UNIT VOL.
132115-019	■ AZZURRO/BLUE RAL5014	x1	10	400	460	0,90	mc. 0,008
132104-019	■ GRIGIO/GRAY RAL7003	x1	10	400	460	0,90	mc. 0,008
132103-019	■ NERO/BLACK	x1	10	400	460	0,90	mc. 0,008
132102-019	■ ROSSO/RED RAL527	x1	10	400	460	0,90	mc. 0,008
132105-019	□ BIANCO/WHITE RAL1013	x1	10	400	460	0,90	mc. 0,008
132116-019	■ VERDE/GREEN RAL6018	x1	10	400	460	0,90	mc. 0,008

08 X3-SEDILE COLORATO A VISTA IN PLASTICA X3-COLORED PLASTIC SEAT							
CODICE/CODE	FINITURA/FINISHING	Q. KIT	Q. MIN/PACK	A	B	KG. x1/WT.x1	VOL. x1/UNIT VOL.
132215-019	■ AZZURRO/BLUE RAL5014	x1	10	450	460	1,20	mc. 0,015
132204-019	■ GRIGIO/GRAY RAL7003	x1	10	450	460	1,20	mc. 0,015
132203-019	■ NERO/BLACK	x1	10	450	460	1,20	mc. 0,015
132202-019	■ ROSSO/RED RAL527	x1	10	450	460	1,20	mc. 0,015
132205-019	□ BIANCO/WHITE RAL1013	x1	10	450	460	1,20	mc. 0,015
132216-019	■ VERDE/GREEN RAL6018	x1	10	450	460	1,20	mc. 0,015

09 X3-SOTTOSEDILE COLORATO A VISTA IN PLASTICA X3-OUTER COLORED PLASTIC SEAT							
CODICE/CODE	FINITURA/FINISHING	Q. KIT	Q. MIN/PACK	A	B	KG. x1/WT.x1	VOL. x1/UNIT VOL.
132215-009	■ AZZURRO/BLUE RAL5014	x1	20	450	460	0,73	mc. 0,007
132204-009	■ GRIGIO/GRAY RAL7003	x1	20	450	460	0,73	mc. 0,007
132203-009	■ NERO/BLACK	x1	20	450	460	0,73	mc. 0,007
132202-009	■ ROSSO/RED RAL527	x1	20	450	460	0,73	mc. 0,007
132205-009	□ BIANCO/WHITE RAL1013	x1	20	450	460	0,73	mc. 0,007
132216-009	■ VERDE/GREEN RAL6018	x1	20	450	460	0,73	mc. 0,007

10 X3-RIDUTTORE PER SCHIENALE IN PLASTICA X3-PLASTIC ADAPTER FOR THE BACK						
CODICE/CODE	FINITURA/FINISHING	Q. KIT	Q. MIN/PACK	KG. x1/WT.x1	VOL. x1/UNIT VOL.	
132103-009	■ NERO/BLACK	x2	200	0,019	mc. 0,0001	

20 X3-PANNELLO SCHIENALE DA TAPPEZZARE IN PLASTICA X3-BACK PANEL FOR UPHOLSTERY							
CODICE/CODE	FINITURA/FINISHING	Q. KIT	Q. MIN/PACK	A	B	KG. x1/WT.x1	VOL. x1/UNIT VOL.
132103-008	■ NERO/BLACK	x1	20	350	385	0,50	mc. 0,003

21 X3-PANNELLO SEDILE DA TAPPEZZARE IN PLASTICA X3-SEAT PANEL FOR UPHOLSTERY							
CODICE/CODE	FINITURA/FINISHING	Q. KIT	Q. MIN/PACK	A	B	KG. x1/WT.x1	VOL. x1/UNIT VOL.
132203-003	■ NERO/BLACK	x1	20	400	410	0,60	mc. 0,003

35 VITE HILO TBL+ FR. D. 5X14 ZINCATO NERA (PER FISSARE PANNELLO SEDILE/SCHIENALE) SCREW TBL+FR.HILO D.5X14 ZINC.BLACK (TO FIX SEAT AND BACK PANEL)						
CODICE/CODE	FINITURA/FINISHING	Q. KIT SEDILE/NR.SEAT	Q. KIT SCHIENALE/NR.BACK			
117803-154	■ NERO/BLACK	x8	x6			

OPTIONAL GAMBA LEG OPTIONAL

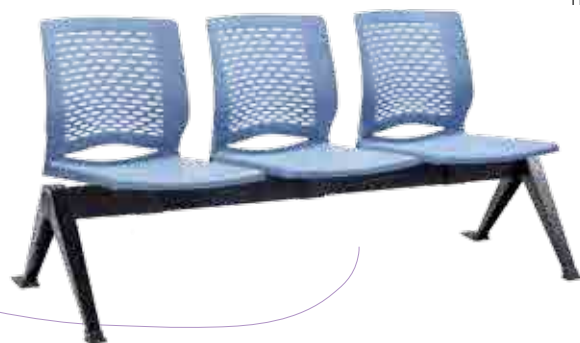

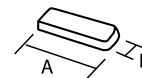
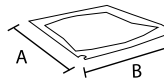
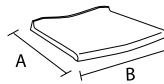
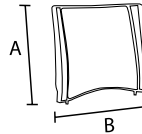
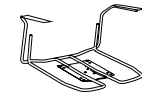
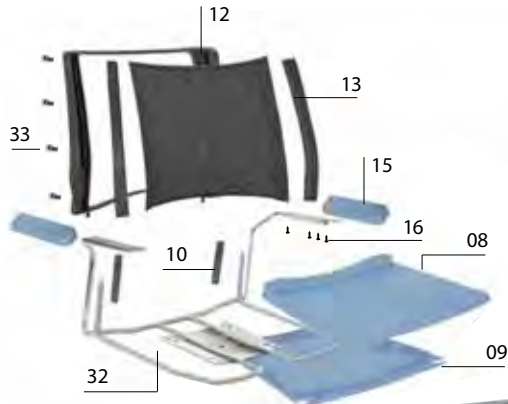

PER I COMPONENTI DELLA PANCA VAI A PAG. 337
FOR THE BENCH COMPONENTS GO TO PAGE 337

98
X3

32 X3-TELAIO PER PANCA CON BRACCIOLI X3-BENCH WIRE FRAME D.12 WITH ARMS					
CODICE/CODE	FINITURA/FINISHING	Q. KIT	Q. MIN/PACK	KG. x1/WT.x1	VOL. x1/UNIT VOL.
110703-044	■ NERO/BLACK	x1	100	3,60	mc. 0,02
110704-210	■ GRIGIO/GRAY	x1	100	3,60	mc. 0,02
110710-044	■ CROMATO/CHROME	x1	100	3,60	mc. 0,02

12 X3-SCHIENALE PER RETE COLORATO A VISTA IN PLASTICA X3-COLORED PLASTIC FOR MESH BACK							
CODICE/CODE	FINITURA/FINISHING	Q. KIT	Q. MIN/PACK	A	B	KG. x1/WT.x1	VOL. x1/UNIT VOL.
132115-014	■ AZZURRO/BLUE RAL5014	x1	10	400	460	0,60	mc. 0,008
132104-014	■ GRIGIO/GRAY RAL7003	x1	10	400	460	0,60	mc. 0,008
132103-014	■ NERO/BLACK	x1	10	400	460	0,60	mc. 0,008
132102-014	■ ROSSO/RED RAL527	x1	10	400	460	0,60	mc. 0,008
132105-014	□ BIANCO/WHITE RAL1013	x1	10	400	460	0,60	mc. 0,008
132116-014	■ VERDE/GREEN RAL6018	x1	10	400	460	0,60	mc. 0,008

13 X3-LISTE A+B PER SCHIENALE RETE COLORATE A VISTA X3-COLORED PLASTIC STRIPS A+B FOR MESH BACK					
CODICE/CODE	FINITURA/FINISHING	Q. KIT	Q. MIN/PACK	KG. x1/WT.x1	VOL. x1/UNIT VOL.
132115-013	■ AZZURRO/BLUE RAL5014	x1	100	0,21	mc. 0,0004
132104-013	■ GRIGIO/GRAY RAL7003	x1	100	0,21	mc. 0,0004
132103-013	■ NERO/BLACK	x1	100	0,21	mc. 0,0004
132102-013	■ ROSSO/RED RAL527	x1	100	0,21	mc. 0,0004
132105-018	□ BIANCO/WHITE RAL1013	x1	100	0,21	mc. 0,0004
132116-013	■ VERDE/GREEN RAL6018	x1	100	0,21	mc. 0,0004

08 X3-SEDILO COLORATO A VISTA IN PLASTICA X3-COLORED PLASTIC SEAT							
CODICE/CODE	FINITURA/FINISHING	Q. KIT	Q. MIN/PACK	A	B	KG. x1/WT.x1	VOL. x1/UNIT VOL.
132215-019	■ AZZURRO/BLUE RAL5014	x1	10	450	460	1,20	mc. 0,015
132204-019	■ GRIGIO/GRAY RAL7003	x1	10	450	460	1,20	mc. 0,015
132203-019	■ NERO/BLACK	x1	10	450	460	1,20	mc. 0,015
132202-019	■ ROSSO/RED RAL527	x1	10	450	460	1,20	mc. 0,015
132205-019	□ BIANCO/WHITE RAL1013	x1	10	450	460	1,20	mc. 0,015
132216-019	■ VERDE/GREEN RAL6018	x1	10	450	460	1,20	mc. 0,015

09 X3-SOTTOSEDILO COLORATO A VISTA IN PLASTICA X3-OUTER COLORED PLASTIC SEAT							
CODICE/CODE	FINITURA/FINISHING	Q. KIT	Q. MIN/PACK	A	B	KG. x1/WT.x1	VOL. x1/UNIT VOL.
132215-009	■ AZZURRO/BLUE RAL5014	x1	20	450	460	0,73	mc. 0,007
132204-009	■ GRIGIO/GRAY RAL7003	x1	20	450	460	0,73	mc. 0,007
132203-009	■ NERO/BLACK	x1	20	450	460	0,73	mc. 0,007
132202-009	■ ROSSO/RED RAL527	x1	20	450	460	0,73	mc. 0,007
132205-009	□ BIANCO/WHITE RAL1013	x1	20	450	460	0,73	mc. 0,007
132216-009	■ VERDE/GREEN RAL6018	x1	20	450	460	0,73	mc. 0,007

10 X3-RIDUTTORE PER SCHIENALE IN PLASTICA X3-PLASTIC ADAPTER FOR THE BACK					
CODICE/CODE	FINITURA/FINISHING	Q. KIT	Q. MIN/PACK	KG. x1/WT.x1	VOL. x1/UNIT VOL.
132103-009	■ NERO/BLACK	x2	200	0,019	mc. 0,0001

15 X3-BRACCIOLO PLASTICA COLORATO PER TELAIO FILO X3-PLASTIC ARMS COLORED FOR WIRE FRAME							
CODICE/CODE	FINITURA/FINISHING	Q. KIT	Q. MIN/PACK	A	B	KG. x1/WT.x1	VOL. x1/UNIT VOL.
131715-019	■ AZZURRO/BLUE RAL5014	x2	40	175	55	0,10	mc. 0,0004
131704-019	■ GRIGIO/GRAY RAL7003	x2	40	175	55	0,10	mc. 0,0004
131703-019	■ NERO/BLACK	x2	40	175	55	0,10	mc. 0,0004
131702-019	■ ROSSO/RED RAL527	x2	40	175	55	0,10	mc. 0,0004
131705-019	□ BIANCO/WHITE RAL1013	x2	40	175	55	0,10	mc. 0,0004
131716-019	■ VERDE/GREEN RAL6018	x2	40	175	55	0,10	mc. 0,0004

16 VITE HILO TBL+ FR. D.5X12 ZINCATA NERA(PER FISSARE BRACCIOLO TONDINO) SCREW TBL+FR.HILO D.5X12 ZINC.BLACK(FOR FIX WIRE ARMS)					
CODICE/CODE	FINITURA/FINISHING	Q. KIT			
117803-154	■ NERO/BLACK	x8			

33 VITE TRUCCIOLARE TSP+ D.3,5X10 BRUNITA NERA(PER FISSARE SCHIENALE RETE) SHAVING SCREW TSP+ D.3.5X10 ZINC.(TO FIX MESH BACK)					
CODICE/CODE	FINITURA/FINISHING	Q. KIT			
117803-105	■ NERO/BLACK	x8			

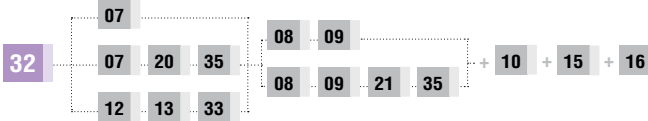
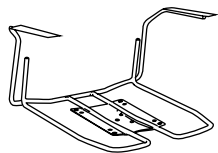
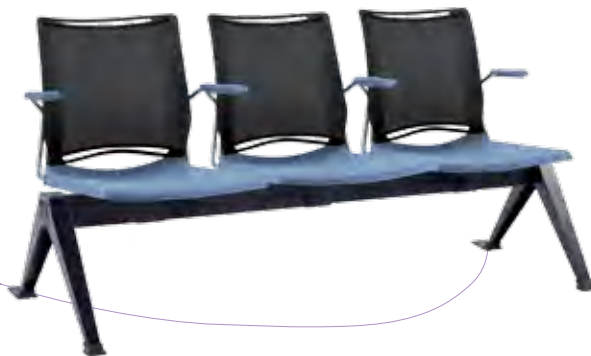

BENCH OPTIONS:

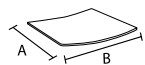
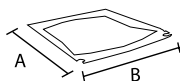
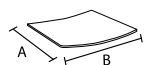
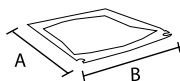
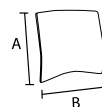
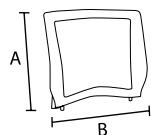

07 X3-SCHIENALE COLORATO A VISTA IN PLASTICA

X3-COLORED PLASTIC BACK

CODICE/CODE	FINITURA/FINISHING	Q.KIT	Q.MIN/PACK	A	B	KG.x1/WT.x1	VOL.x1/UNIT VOL.
132115-019	■ AZZURRO/BLUE RAL5014	x1	10	400	460	0,90	mc. 0,008
132104-019	■ GRIGIO/GRAY RAL7003	x1	10	400	460	0,90	mc. 0,008
132103-019	■ NERO/BLACK	x1	10	400	460	0,90	mc. 0,008
132102-019	■ ROSSO/RED RAL527	x1	10	400	460	0,90	mc. 0,008
132105-019	□ BIANCO/WHITE RAL1013	x1	10	400	460	0,90	mc. 0,008
132116-019	■ VERDE/GREEN RAL6018	x1	10	400	460	0,90	mc. 0,008

20 X3-PANNELLO SCHIENALE DA TAPPEZZARE IN PLASTICA

X3-BACK PANEL FOR UPHOLSTERY

CODICE/CODE	FINITURA/FINISHING	Q.KIT	Q.MIN/PACK	A	B	KG.x1/WT.x1	VOL.x1/UNIT VOL.
132103-008	■ NERO/BLACK	x1	20	350	385	0,50	mc. 0,003

08 X3-SEDILE COLORATO A VISTA IN PLASTICA

X3-COLORED PLASTIC SEAT

CODICE/CODE	FINITURA/FINISHING	Q.KIT	Q.MIN/PACK	A	B	KG.x1/WT.x1	VOL.x1/UNIT VOL.
132215-019	■ AZZURRO/BLUE RAL5014	x1	10	450	460	1,20	mc. 0,015
132204-019	■ GRIGIO/GRAY RAL7003	x1	10	450	460	1,20	mc. 0,015
132203-019	■ NERO/BLACK	x1	10	450	460	1,20	mc. 0,015
132202-019	■ ROSSO/RED RAL527	x1	10	450	460	1,20	mc. 0,015
132205-019	□ BIANCO/WHITE RAL1013	x1	10	450	460	1,20	mc. 0,015
132216-019	■ VERDE/GREEN RAL6018	x1	10	450	460	1,20	mc. 0,015

09 X3-SOTTOSEDILE COLORATO A VISTA IN PLASTICA

X3-OUTER COLORED PLASTIC SEAT

CODICE/CODE	FINITURA/FINISHING	Q.KIT	Q.MIN/PACK	A	B	KG.x1/WT.x1	VOL.x1/UNIT VOL.
132215-009	■ AZZURRO/BLUE RAL5014	x1	20	450	460	0,73	mc. 0,007
132204-009	■ GRIGIO/GRAY RAL7003	x1	20	450	460	0,73	mc. 0,007
132203-009	■ NERO/BLACK	x1	20	450	460	0,73	mc. 0,007
132202-009	■ ROSSO/RED RAL527	x1	20	450	460	0,73	mc. 0,007
132205-009	□ BIANCO/WHITE RAL1013	x1	20	450	460	0,73	mc. 0,007
132216-009	■ VERDE/GREEN RAL6018	x1	20	450	460	0,73	mc. 0,007

21 X3-PANNELLO SEDILE DA TAPPEZZARE IN PLASTICA

X3-SEAT PANEL FOR UPHOLSTERY

CODICE/CODE	FINITURA/FINISHING	Q.KIT	Q.MIN/PACK	A	B	KG.x1/WT.x1	VOL.x1/UNIT VOL.
132203-003	■ NERO/BLACK	x1	20	400	410	0,60	mc. 0,003

+ 35 VITI / SCREWS

08 X3-SEDILE COLORATO A VISTA IN PLASTICA

X3-COLORED PLASTIC SEAT

CODICE/CODE	FINITURA/FINISHING	Q.KIT	Q.MIN/PACK	A	B	KG.x1/WT.x1	VOL.x1/UNIT VOL.
132215-019	■ AZZURRO/BLUE RAL5014	x1	10	450	460	1,20	mc. 0,015
132204-019	■ GRIGIO/GRAY RAL7003	x1	10	450	460	1,20	mc. 0,015
132203-019	■ NERO/BLACK	x1	10	450	460	1,20	mc. 0,015
132202-019	■ ROSSO/RED RAL527	x1	10	450	460	1,20	mc. 0,015
132205-019	□ BIANCO/WHITE RAL1013	x1	10	450	460	1,20	mc. 0,015
132216-019	■ VERDE/GREEN RAL6018	x1	10	450	460	1,20	mc. 0,015

09 X3-SOTTOSEDILE COLORATO A VISTA IN PLASTICA

X3-OUTER COLORED PLASTIC SEAT

CODICE/CODE	FINITURA/FINISHING	Q.KIT	Q.MIN/PACK	A	B	KG.x1/WT.x1	VOL.x1/UNIT VOL.
132215-009	■ AZZURRO/BLUE RAL5014	x1	20	450	460	0,73	mc. 0,007
132204-009	■ GRIGIO/GRAY RAL7003	x1	20	450	460	0,73	mc. 0,007
132203-009	■ NERO/BLACK	x1	20	450	460	0,73	mc. 0,007
132202-009	■ ROSSO/RED RAL527	x1	20	450	460	0,73	mc. 0,007
132205-009	□ BIANCO/WHITE RAL1013	x1	20	450	460	0,73	mc. 0,007
132216-009	■ VERDE/GREEN RAL6018	x1	20	450	460	0,73	mc. 0,007

21 X3-PANNELLO SEDILE DA TAPPEZZARE IN PLASTICA

X3-SEAT PANEL FOR UPHOLSTERY

CODICE/CODE	FINITURA/FINISHING	Q.KIT	Q.MIN/PACK	A	B	KG.x1/WT.x1	VOL.x1/UNIT VOL.
132203-003	■ NERO/BLACK	x1	20	400	410	0,60	mc. 0,003

+ 35 VITI / SCREWS

OPTIONAL GAMBA
LEG OPTIONAL





NEW

ALBA  



SLIDE

4 LEGS

SWIVEL

BENCH



DUETTO

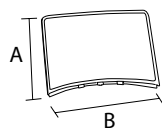
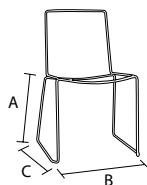

102
DUETTO

01 DUETTO-TELAIO A SLITTA IN TONDINO D.11 DUETTO-SLIDE WIRE FRAME D.11									
CODICE/CODE	FINITURA/FINISHING	Q. KIT	Q. MIN/PACK	A	B	C	KG. x1/WT.x1	VOL. x1/UNIT VOL.	
113410-046	■ CROMATO/CHROME	x1	100	450	510	480	4,40	mc. 0,02	

02 BASE PIANA A PINZA IN PE PER TONDO CLIPS BASE FOR TUBE									
CODICE/CODE	FINITURA/FINISHING	Q. KIT							
134006-020	□ NEUTRO/NEUTRAL	x4							

03 BASE PIANA A PINZA DOPPIA IN PE PER TONDO PER UNIONE SEDIE DOUBLE FLAT CLIP BASE FOR TUBE									
CODICE/CODE	FINITURA/FINISHING	Q. KIT							
134006-021	□ NEUTRO/NEUTRAL	x4							

04 BTF-KIT PIEDINI BTF-KIT FEET									
CODICE/CODE	FINITURA/FINISHING	Q. KIT	Q. MIN/PACK	KG. x1/WT.x1					
134306-001	□ NEUTRO/NEUTRAL	x1	100	0,05					

05 BTFA-KIT PIEDINI CON GANCI BTFA-KIT FEET WITH HOOKS									
CODICE/CODE	FINITURA/FINISHING	Q. KIT	Q. MIN/PACK	KG. x1/WT.x1					
134306-002	□ NEUTRO/NEUTRAL	x1	100	0,06					

06 PPTF-TAPPO PER FISSAGGIO PAVIMENTO PPTF-CAP FOR FIXING TO THE FLOOR									
CODICE/CODE	FINITURA/FINISHING	Q. KIT	Q. MIN/PACK	KG. x1/WT.x1					
134306-003	□ NEUTRO/NEUTRAL	x2	100	0,03					

07 DUETTO-SEDILE A VISTA IN PLASTICA COLORATO DUETTO-PLASTIC SEAT COLORED									
CODICE/CODE	FINITURA/FINISHING	Q. KIT	Q. MIN/PACK	A	B	C	KG. x1/WT.x1	VOL. x1/UNIT VOL.	
132215-022	■ BLU/BLUE	x1	10	180	390	430	0,80	mc. 0,009	
132207-022	■ SABBIA/SAND	x1	10	180	390	430	0,80	mc. 0,009	
132203-022	■ NERO/BLACK	x1	10	180	390	430	0,80	mc. 0,009	
132204-022	■ GRIGIO/GREY	x1	10	180	390	430	0,80	mc. 0,009	
132205-022	□ AVORIO/IVORY	x1	10	180	390	430	0,80	mc. 0,009	

08 DUETTO-SCHIENALE A VISTA IN PLASTICA COLORATO DUETTO-PLASTIC BACK COLORED									
CODICE/CODE	FINITURA/FINISHING	Q. KIT	Q. MIN/PACK	A	B	KG. x1/WT.x1			
132115-022	■ BLU/BLUE	x1	20	280	395	0,40			
132107-022	■ SABBIA/SAND	x1	20	280	395	0,40			
132103-022	■ NERO/BLACK	x1	20	280	395	0,40			
132104-022	■ GRIGIO/GREY	x1	20	280	395	0,40			
132105-022	□ AVORIO/IVORY	x1	20	280	395	0,40			

DUETTO-CARRELLO PORTASEDIE CON ACCESSORI NERO DUETTO-TROLLEY FOR CHAIRS WITH ACCESSORIES BLACK									
CODICE/CODE	FINITURA/FINISHING	Q. KIT							
110803-054	■ NERO/BLACK	x1							

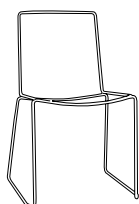

01 + 07 + 08 + 02
OPTIONAL
03
OPTIONAL
04
OPTIONAL
05 + 06
OPTIONAL OPTIONAL



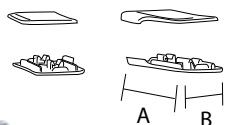
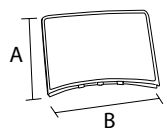
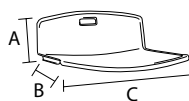
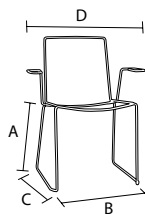

01	DUETTO-TELAIO A SLITTA IN TONDINO D.11 CON BRACCIOLI DUETTO-SLIDE WIRE FRAME D.11 WITH ARMS									
CODICE/CODE	FINITURA/FINISHING	Q. KIT	Q. MIN/PACK	A	B	C	D	KG.x1/WT.x1	VOL.x1/UNIT VOL.	
113410-047	■ CROMATO/CHROME	x1	50	450	510	480	650	5,40	mc. 0,04	

02	BASE PIANA A PINZA IN PE PER TONDO CLIPS BASE FOR TUBE									
CODICE/CODE	FINITURA/FINISHING	Q. KIT								
134006-020	□ NEUTRO/NEUTRAL	x4								

03	BASE PIANA A PINZA DOPPIA IN PE PER TONDO PER UNIONE SEDIE DOUBLE FLAT CLIP BASE FOR TUBE									
CODICE/CODE	FINITURA/FINISHING	Q. KIT								
134006-021	□ NEUTRO/NEUTRAL	x4								

04	BTF-KIT PIEDINI BTF-KIT FEET									
CODICE/CODE	FINITURA/FINISHING	Q. KIT	Q. MIN/PACK					KG.x1/WT.x1		
134306-001	□ NEUTRO/NEUTRAL	x1	100					0,05		

05	BTFA-KIT PIEDINI CON GANCI BTFA-KIT FEET WITH HOOKS									
CODICE/CODE	FINITURA/FINISHING	Q. KIT	Q. MIN/PACK					KG.x1/WT.x1		
134306-002	□ NEUTRO/NEUTRAL	x1	100					0,06		

06	PPTF-TAPPO PER FISSAGGIO PAVIMENTO PPTF-CAP FOR FIXING TO THE FLOOR									
CODICE/CODE	FINITURA/FINISHING	Q. KIT	Q. MIN/PACK					KG.x1/WT.x1		
134306-003	□ NEUTRO/NEUTRAL	x2	100					0,03		

07	DUETTO-SEDILE A VISTA IN PLASTICA COLORATO DUETTO-PLASTIC SEAT COLORED									
CODICE/CODE	FINITURA/FINISHING	Q. KIT	Q. MIN/PACK	A	B	C		KG.x1/WT.x1	VOL.x1/UNIT VOL.	
132215-022	■ BLU/BLUE	x1	10	180	390	430		0,80	mc. 0,009	
132207-022	■ SABBIA/SAND	x1	10	180	390	430		0,80	mc. 0,009	
132203-022	■ NERO/BLACK	x1	10	180	390	430		0,80	mc. 0,009	
132204-022	■ GRIGIO/GREY	x1	10	180	390	430		0,80	mc. 0,009	
132205-022	□ AVORIO/IVORY	x1	10	180	390	430		0,80	mc. 0,009	

08	DUETTO-SCHIENALE A VISTA IN PLASTICA COLORATO DUETTO-PLASTIC BACK COLORED									
CODICE/CODE	FINITURA/FINISHING	Q. KIT	Q. MIN/PACK	A	B			KG.x1/WT.x1	VOL.x1/UNIT VOL.	
132115-022	■ BLU/BLUE	x1	20	280	395			0,40	mc. 0,003	
132107-022	■ SABBIA/SAND	x1	20	280	395			0,40	mc. 0,003	
132103-022	■ NERO/BLACK	x1	20	280	395			0,40	mc. 0,003	
132104-022	■ GRIGIO/GREY	x1	20	280	395			0,40	mc. 0,003	
132105-022	□ AVORIO/IVORY	x1	20	280	395			0,40	mc. 0,003	

10	DUETTO-COPPIA BRACCIOLI IN PLASTICA COLORATA DUETTO-PAIR COLORED PLASTIC ARMS									
CODICE/CODE	FINITURA/FINISHING	Q. KIT	Q. MIN/PACK	A	B			KG.x1/WT.x1	VOL.x1/UNIT VOL.	
131715-075	■ BLU/BLUE	x1	20	180	70			0,20	mc. 0,001	
131707-075	■ SABBIA/SAND	x1	20	180	70			0,20	mc. 0,001	
131703-075	■ NERO/BLACK	x1	20	180	70			0,20	mc. 0,001	
131704-075	■ GRIGIO/GREY	x1	20	180	70			0,20	mc. 0,001	
131705-075	□ AVORIO/IVORY	x1	20	180	70			0,20	mc. 0,001	

OPTIONAL 02
BASE PIANA A PINZA
CLIPS BASE



OPTIONAL 03
BASE PIANA A PINZA DOPPIA
DOUBLE FLAT CLIP BASE



OPTIONAL 04
BTF-KIT PIEDINI
BTF-KIT FEET



OPTIONAL 05
BTFA-KIT PIEDINI CON GANCI
BTFA-KIT FEET WITH HOOKS



OPTIONAL 06
PPTF-TAPPO PER FISSAGGIO PAVIMENTO
PPTF-CAP FOR FIXING TO THE FLOOR



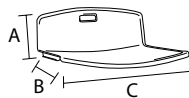
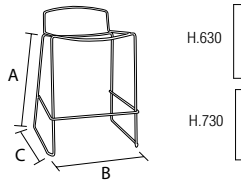

11	DUETTO-SGABELLO ALTO H.630 IN TONDINO D.11 DUETTO-WIRE HIGH BAR STOOL H.630 D.11								
	CODICE/CODE 113410-048	FINITURA/FINISHING ■ CROMATO/CHROME	Q.KIT x1	Q.MIN/PACK 50	A 630	B 525	C 500	KG.x1/WT.x1 5,70	VOL.x1/UNIT.VOL. mc. 0,04
11	DUETTO-SGABELLO ALTO H.730 IN TONDINO D.11 DUETTO-WIRE HIGH BAR STOOL H.730 D.11								
	CODICE/CODE 113410-049	FINITURA/FINISHING ■ CROMATO/CHROME	Q.KIT x1	Q.MIN/PACK 50	A 730	B 525	C 500	KG.x1/WT.x1 6,00	VOL.x1/UNIT.VOL. mc. 0,04
02	BASE PIANA A PINZA IN PE PER TONDO CLIPS BASE FOR TUBE								
	CODICE/CODE 134006-020	FINITURA/FINISHING □ NEUTRO/NEUTRAL	Q.KIT x4						
04	BTF-KIT PIEDINI BTF-KIT FEET								
	CODICE/CODE 134306-001	FINITURA/FINISHING □ NEUTRO/NEUTRAL	Q.KIT x1	Q.MIN/PACK 100				KG.x1/WT.x1 0,05	
07	DUETTO-SEDILE A VISTA IN PLASTICA COLORATO DUETTO-PLASTIC SEAT COLORED								
	CODICE/CODE 132215-022	FINITURA/FINISHING ■ BLU/BLUE RAL5014	Q.KIT x1	Q.MIN/PACK 10	A 180	B 390	C 430	KG.x1/WT.x1 0,80	VOL.x1/UNIT.VOL. mc. 0,009
	132207-022	■ SABBIA/SAND RAL1019	x1	10	180	390	430	0,80	mc. 0,009
	132203-022	■ NERO/BLACK	x1	10	180	390	430	0,80	mc. 0,009
	132204-022	■ GRIGIO/GREY RAL7003	x1	10	180	390	430	0,80	mc. 0,009
	132205-022	□ AVORIO/IVORY RAL1013	x1	10	180	390	430	0,80	mc. 0,009

104
DUETTO

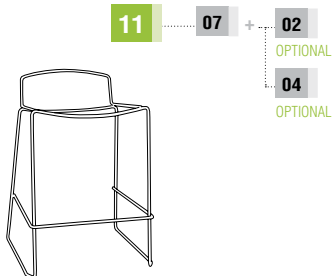

OPTIONAL 02
BASE PIANA A PINZA
CLIPS BASE



OPTIONAL 04
BTF-KIT PIEDINI
BTF-KIT FEET



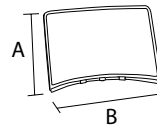
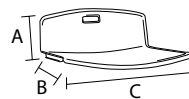
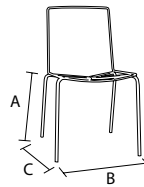

12 DUETTO-TELAIO 4 GAMBE IN TUBO D.16 SENZA TAPPI

DUETTO-4 LEGS FRAMES D.16 WITHOUT CAPS

CODICE/CODE	FINITURA/FINISHING		Q. KIT	Q. MIN/PACK	A	B	C	KG.x1/WT.x1	VOL.x1/UNIT VOL.
112710-036	■ CROMATO/CHROME		x1	100	450	510	480	3,70	mc. 0,02
112703-036	■ NERO/BLACK		x1	100	450	510	480	3,70	mc. 0,02
112704-036	■ GRIGIO/GREY	IKEA 4	x1	100	450	510	480	3,70	mc. 0,02
112705-036	□ AVORIO/IVORY	RAL1013	x1	100	450	510	480	3,70	mc. 0,02

13 PUNTALE ALETTATO TONDO D.16 NERO

INNER CAP FOR LEGS D.16 BLACK

CODICE/CODE	FINITURA/FINISHING	Q. KIT
134203-160	■ NERO/BLACK	x4

07 DUETTO-SEDILE A VISTA IN PLASTICA COLORATO

DUETTO-PLASTIC SEAT COLORED

CODICE/CODE	FINITURA/FINISHING		Q. KIT	Q. MIN/PACK	A	B	C	KG.x1/WT.x1	VOL.x1/UNIT VOL.
132215-022	■ BLU/BLUE	RAL5014	x1	10	180	390	430	0,80	mc. 0,009
132207-022	■ SABBIA/SAND	RAL1019	x1	10	180	390	430	0,80	mc. 0,009
132203-022	■ NERO/BLACK		x1	10	180	390	430	0,80	mc. 0,009
132204-022	■ GRIGIO/GREY	RAL7003	x1	10	180	390	430	0,80	mc. 0,009
132205-022	□ AVORIO/IVORY	RAL1013	x1	10	180	390	430	0,80	mc. 0,009

08 DUETTO-SCHIENALE A VISTA IN PLASTICA COLORATO

DUETTO-PLASTIC BACK COLORED

CODICE/CODE	FINITURA/FINISHING		Q. KIT	Q. MIN/PACK	A	B	KG.x1/WT.x1	VOL.x1/UNIT VOL.
132115-022	■ BLU/BLUE	RAL5014	x1	20	280	395	0,40	mc. 0,003
132107-022	■ SABBIA/SAND	RAL1019	x1	20	280	395	0,40	mc. 0,003
132103-022	■ NERO/BLACK		x1	20	280	395	0,40	mc. 0,003
132104-022	■ GRIGIO/GREY	RAL7003	x1	20	280	395	0,40	mc. 0,003
132105-022	□ AVORIO/IVORY	RAL1013	x1	20	280	395	0,40	mc. 0,003

DUETTO-CARRELLINO PORTASEDIE CON ACCESSORI NERO

DUETTO-TROLLEY FOR CHAIRS WITH ACCESSORIES BLACK

CODICE/CODE	FINITURA/FINISHING	Q. KIT
110803-054	■ NERO/BLACK	x1

12 + 07 + 08 + 13



DUETTO 4-LEGS



106
DUETTO

14 DUETTO-TELAIO 4 GAMBE D.16 CON BRACCIOLI SENZA TAPPI

DUETTO-4 LEGS FRAME D.16 WITH ARM AND WITHOUT CAPS

CODICE/CODE	FINITURA/FINISHING	Q.KIT	Q.MIN/PACK	A	B	C	D	KG.x1/WT.x1	VOL.x1/UNIT VOL.
112710-035	■ CROMATO/CHROME	x1	50	450	510	480	650	4,70	mc. 0,04
112703-035	■ NERO/BLACK	x1	50	450	510	480	650	4,70	mc. 0,04
112704-035	■ GRIGIO/GREY IKEA 4	x1	50	450	510	480	650	4,70	mc. 0,04
112705-035	□ AVORIO/IVORY RAL1013	x1	50	450	510	480	650	4,70	mc. 0,04

13 PUNTALE ALETTATO TONDO D.16 NERO

INNER CAP FOR LEGS D.16 BLACK

CODICE/CODE	FINITURA/FINISHING	Q.KIT
134203-160	■ NERO/BLACK	x4

07 DUETTO-SEDILE A VISTA IN PLASTICA COLORATO

DUETTO-PLASTIC SEAT COLORED

CODICE/CODE	FINITURA/FINISHING	Q.KIT	Q.MIN/PACK	A	B	C	KG.x1/WT.x1	VOL.x1/UNIT VOL.
132215-022	■ BLU/BLUE RAL5014	x1	10	180	390	430	0,80	mc. 0,009
132207-022	■ SABBIA/SAND RAL1019	x1	10	180	390	430	0,80	mc. 0,009
132203-022	■ NERO/BLACK	x1	10	180	390	430	0,80	mc. 0,009
132204-022	■ GRIGIO/GREY RAL7003	x1	10	180	390	430	0,80	mc. 0,009
132205-022	□ AVORIO/IVORY RAL1013	x1	10	180	390	430	0,80	mc. 0,009

08 DUETTO-SCHIENALE A VISTA IN PLASTICA COLORATO

DUETTO-PLASTIC BACK COLORED

CODICE/CODE	FINITURA/FINISHING	Q.KIT	Q.MIN/PACK	A	B	KG.x1/WT.x1	VOL.x1/UNIT VOL.
132115-022	■ BLU/BLUE RAL5014	x1	20	280	395	0,40	mc. 0,003
132107-022	■ SABBIA/SAND RAL1019	x1	20	280	395	0,40	mc. 0,003
132103-022	■ NERO/BLACK	x1	20	280	395	0,40	mc. 0,003
132104-022	■ GRIGIO/GREY RAL7003	x1	20	280	395	0,40	mc. 0,003
132105-022	□ AVORIO/IVORY RAL1013	x1	20	280	395	0,40	mc. 0,003

10 DUETTO-COPPIA BRACCIOLI IN PLASTICA COLORATA

DUETTO-PAIR COLORED PLASTIC ARMS

CODICE/CODE	FINITURA/FINISHING	Q.KIT	Q.MIN/PACK	A	B	KG.x1/WT.x1	VOL.x1/UNIT VOL.
131715-075	■ BLU/BLUE RAL5014	x1	20	180	70	0,20	mc. 0,001
131707-075	■ SABBIA/SAND RAL1019	x1	20	180	70	0,20	mc. 0,001
131703-075	■ NERO/BLACK	x1	20	180	70	0,20	mc. 0,001
131704-075	■ GRIGIO/GREY RAL7003	x1	20	180	70	0,20	mc. 0,001
131705-075	□ AVORIO/IVORY RAL1013	x1	20	180	70	0,20	mc. 0,001

14 + 07 + 08 + 10 + 13



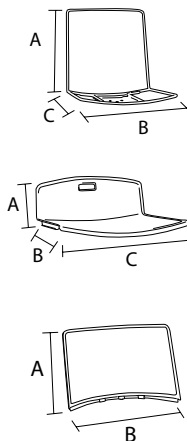

15 DUETTO-SUPPORTO GIREVOLE A GAS PER SCOCCA DUETTO

DUETTO-SWIVEL FRAME FOR DUETTO SHELL

CODICE/CODE	FINITURA/FINISHING	Q. KIT	Q. MIN/PACK	A	B	C	KG. x1/WT.x1	VOL. x1/UNIT VOL.
110910-017	■ CROMATO/CHROME	x1	100	400	430	390	4,00	mc. 0,02

07 DUETTO-SEDILE A VISTA IN PLASTICA COLORATO

DUETTO-PLASTIC SEAT COLORED

CODICE/CODE	FINITURA/FINISHING	Q. KIT	Q. MIN/PACK	A	B	C	KG. x1/WT.x1	VOL. x1/UNIT VOL.
132215-022	■ BLU/BLUE	x1	10	180	390	430	0,80	mc. 0,009
132207-022	■ SABBIA/SAND	x1	10	180	390	430	0,80	mc. 0,009
132203-022	■ NERO/BLACK	x1	10	180	390	430	0,80	mc. 0,009
132204-022	■ GRIGIO/GREY	x1	10	180	390	430	0,80	mc. 0,009
132205-022	□ AVORIO/IVORY	x1	10	180	390	430	0,80	mc. 0,009

08 DUETTO-SCHIENALE A VISTA IN PLASTICA COLORATO

DUETTO-PLASTIC BACK COLORED

CODICE/CODE	FINITURA/FINISHING	Q. KIT	Q. MIN/PACK	A	B	KG. x1/WT.x1	VOL. x1/UNIT VOL.
132115-022	■ BLU/BLUE	x1	20	280	395	0,40	mc. 0,003
132107-022	■ SABBIA/SAND	x1	20	280	395	0,40	mc. 0,003
132103-022	■ NERO/BLACK	x1	20	280	395	0,40	mc. 0,003
132104-022	■ GRIGIO/GREY	x1	20	280	395	0,40	mc. 0,003
132105-022	□ AVORIO/IVORY	x1	20	280	395	0,40	mc. 0,003

15 07 + 08



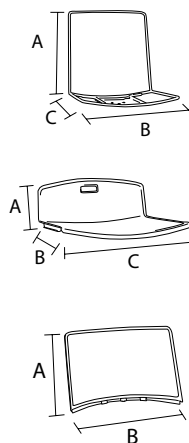

16 DUETTO-SUPPORTO PER ATTACCO SCOCCA DUETTO SU PANCA
DUETTO-BENCH FRAME FOR FEEL SHELL

CODICE/CODE	FINITURA/FINISHING	Q.KIT	Q.MIN/PACK	A	B	C	KG.x1/WT.x1	VOL.x1/UNIT VOL.
110710-018	■ CROMATO/CHROME	x1	100	400	430	390	3,70	mc. 0,02

07 DUETTO-SEDILE A VISTA IN PLASTICA COLORATO
DUETTO-PLASTIC SEAT COLORED

CODICE/CODE	FINITURA/FINISHING	Q.KIT	Q.MIN/PACK	A	B	C	KG.x1/WT.x1	VOL.x1/UNIT VOL.
132215-022	■ BLU/BLUE RAL5014	x1	10	180	390	430	0,80	mc. 0,009
132207-022	■ SABBIA/SAND RAL1019	x1	10	180	390	430	0,80	mc. 0,009
132203-022	■ NERO/BLACK	x1	10	180	390	430	0,80	mc. 0,009
132204-022	■ GRIGIO/GREY RAL7003	x1	10	180	390	430	0,80	mc. 0,009
132205-022	□ AVORIO/IVORY RAL1013	x1	10	180	390	430	0,80	mc. 0,009

08 DUETTO-SCHIENALE A VISTA IN PLASTICA COLORATO
DUETTO-PLASTIC BACK COLORED

CODICE/CODE	FINITURA/FINISHING	Q.KIT	Q.MIN/PACK	A	B	KG.x1/WT.x1	VOL.x1/UNIT VOL.
132115-022	■ BLU/BLUE RAL5014	x1	20	280	395	0,40	mc. 0,003
132107-022	■ SABBIA/SAND RAL1019	x1	20	280	395	0,40	mc. 0,003
132103-022	■ NERO/BLACK	x1	20	280	395	0,40	mc. 0,003
132104-022	■ GRIGIO/GREY RAL7003	x1	20	280	395	0,40	mc. 0,003
132105-022	□ AVORIO/IVORY RAL1013	x1	20	280	395	0,40	mc. 0,003

PER I COMPONENTI DELLA PANCA VAI A PAG. 337
FOR THE BENCH COMPONENTS GO TO PAGE 337

DUETTO

16 07 + 08



OPTIONAL GAMBA
LEG OPTIONAL





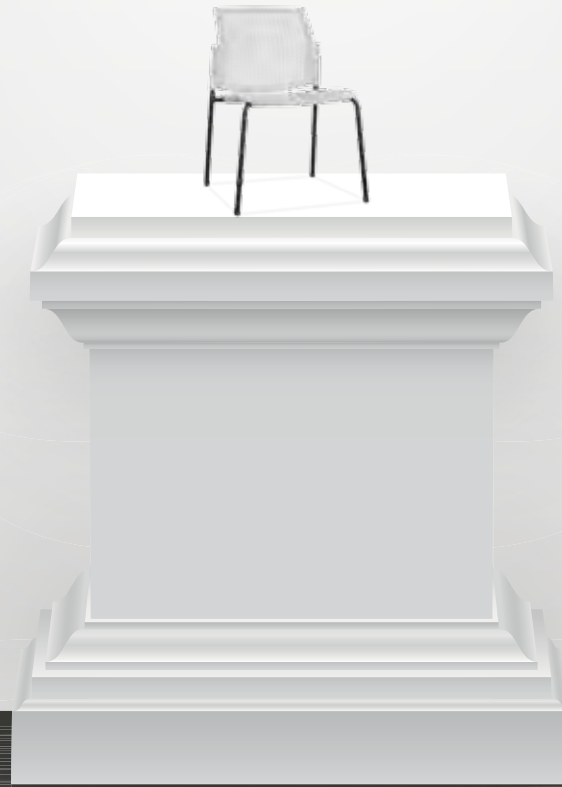
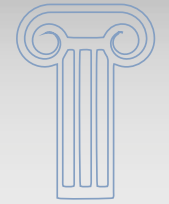
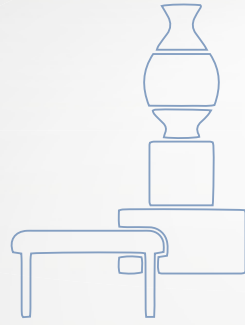
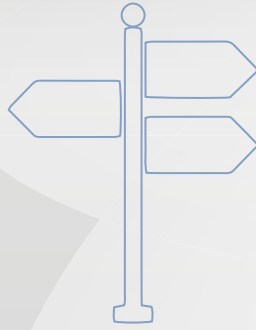

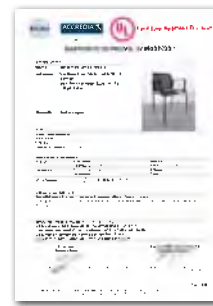

BIFMA



SLIDE

4 LEGS

4 LEGS FOR CASTORS

SWIVEL

BENCH



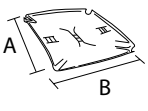
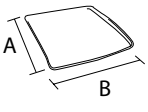
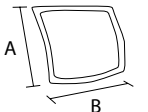
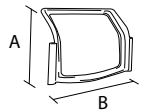
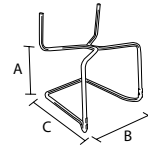
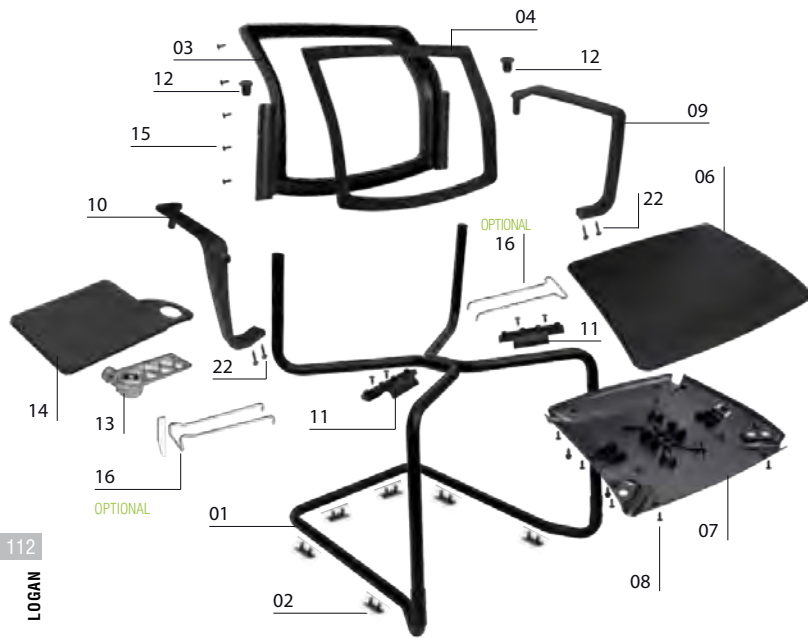

01 LOGAN-BASE A SLITTA IN TUBO ASFORM D.22 TAPPI ESCLUSI
LOGAN-SLIDE FRAME ASFORM PIPE D.22 WITHOUT CAPS

CODICE/CODE	FINITURA/FINISHING	Q. KIT	Q. MIN/PACK	A	B	C	KG. x1/WT.x1	VOL. x1/UNIT VOL.
110503-059	■ NERO/BLACK	x1	40	450	550	550	4,70	mc. 0,06
110504-059	■ GRIGIO/GREY IG2621	x1	40	450	550	550	4,70	mc. 0,06
110510-059	■ CROMATO/CHROME	x1	40	450	550	550	4,70	mc. 0,06

02 P2P-PINZA DUE PIOLI IN POLIETILENE NERA
P2P-TWO PINS PLIERS IN BLACK POLYTHENE

CODICE/CODE	FINITURA/FINISHING	Q. KIT
134003-003	■ NERO/BLACK	x6

03 LOGAN-TELAIO SCHIENALE IN PLASTICA PER RETE (PORTANTE)
LOGAN-BACK FRAME IN PLASTIC FOR MESH

CODICE/CODE	FINITURA/FINISHING	Q. KIT	Q. MIN/PACK	A	B	KG. x1/WT.x1	VOL. x1/UNIT VOL.
132103-084	■ NERO/BLACK	x1	10	390	500	0,58	mc. 0,088

04 LOGAN-CORNICE SCHIENALE IN PLASTICA PER RETE
LOGAN-OPEN FRAME IN PLASTIC FOR MESH

CODICE/CODE	FINITURA/FINISHING	Q. KIT	Q. MIN/PACK	A	B	KG. x1/WT.x1	VOL. x1/UNIT VOL.
132103-085	■ NERO/BLACK	x1	20	380	420	0,30	mc. 0,005

06 LOGAN-SEDILE IN PLASTICA COLORATO A VISTA
LOGAN-PLASTIC SEAT COLOURED AT SIGHT

CODICE/CODE	FINITURA/FINISHING	Q. KIT	Q. MIN/PACK	A	B	KG. x1/WT.x1	VOL. x1/UNIT VOL.
132203-082	■ NERO/BLACK	x1	10	430	460	0,86	mc. 0,01
132204-082	■ GRIGIO/GREY RAL7040	x1	10	430	460	0,86	mc. 0,01
132205-082	□ BIANCO/WHITE RAL9003	x1	10	430	460	0,86	mc. 0,01
132215-082	■ BLU/BLUE RAL5014	x1	10	430	460	0,86	mc. 0,01

07 LOGAN-SOTTOSEDILE IN PLASTICA PER TELAIO 4 GAMBE E SLITTA
LOGAN-OUTER PLASTIC SEAT FOR FOUR LEGS AND SLIDE

CODICE/CODE	FINITURA/FINISHING	Q. KIT	Q. MIN/PACK	A	B	KG. x1/WT.x1	VOL. x1/UNIT VOL.
132203-080	■ NERO/BLACK	x1	20	420	450	0,51	mc. 0,007
132204-080	■ GRIGIO/GREY RAL7040	x1	20	420	450	0,51	mc. 0,007
132205-080	□ BIANCO/WHITE RAL9003	x1	20	420	450	0,51	mc. 0,007
132215-080	■ BLU/BLUE RAL5014	x1	20	420	450	0,51	mc. 0,007

08 LOGAN-SACCHETTO CON N°10 HILO TC+ 5X14 ZN NERE + N°4 PF1 - PER SEDILE
LOGAN-N°10 SCREW HILO THREAD TC+ D.5X14 ZN BLACK + N°4 PF1 (SCREW FOR FIXED SEAT PANEL)

CODICE/CODE	FINITURA/FINISHING	Q. KIT	Q. MIN/PACK
117000-022	■ NERO/BLACK	x1	10

112
LOGAN

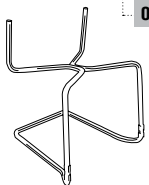
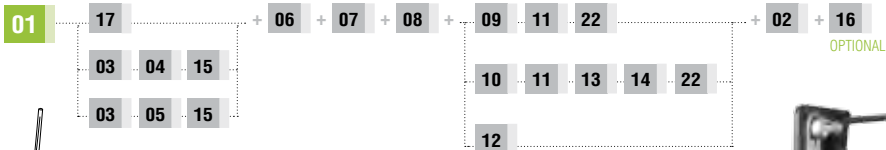

OPTIONAL 16
COPPIA AGGANCIAMENTO LATERALE
PAIR SIDE WIRE HOOKS



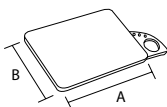
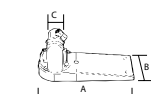
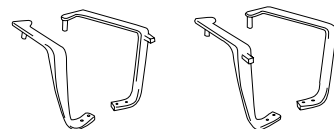
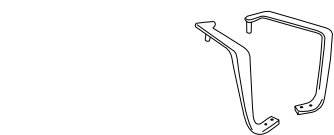
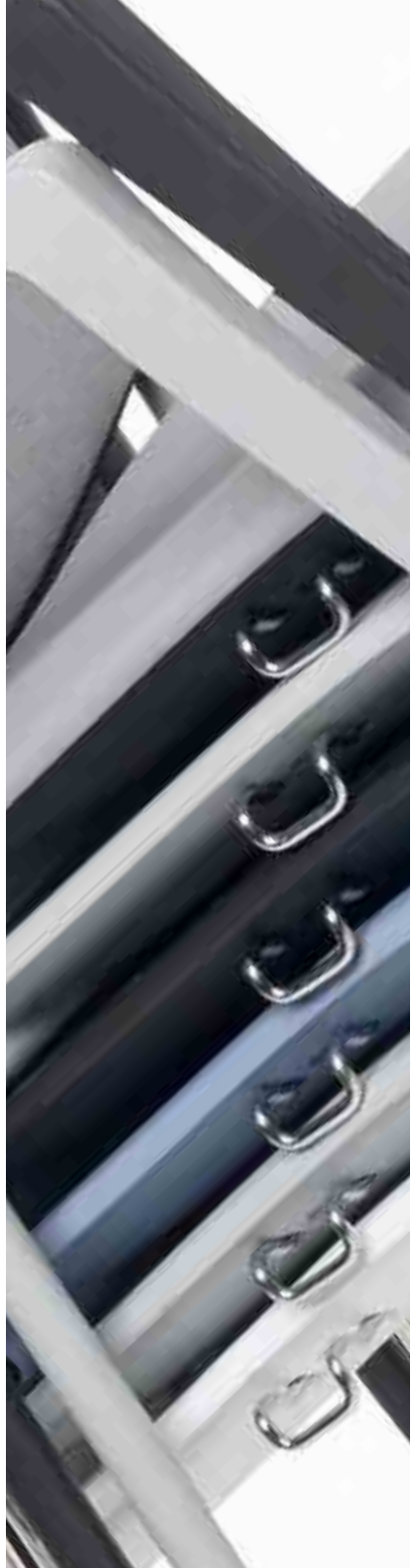

09 LOGAN-COPPIA BRACCIOLI DX/SX IN PLASTICA
LOGAN-PAIR OF PLASTIC ARMS RIGHT/LEFT

CODICE/CODE	FINITURA/FINISHING	Q. KIT	Q. MIN/PACK	KG. x1/WT.x1	VOL. x1/UNIT VOL.
131703-031	■ NERO/BLACK	x1	10	0,43	mc. 0,051
131704-031	■ GRIGIO/GREY RAL7040	x1	10	0,43	mc. 0,051
131705-031	□ BIANCO/WHITE RAL9003	x1	10	0,43	mc. 0,051
131715-031	■ BLU/BLUE RAL5014	x1	10	0,43	mc. 0,051

10 LOGAN-COPPIA BRACCIOLI CON AGGANCIO PORTATAVOLETTA IN PLASTICA
LOGAN-PAIR OF PLASTIC ARMS RIGHT/LEFT WITH WRITING TABLET HOOK

CODICE/CODE	FINITURA/FINISHING	Q. KIT	Q. MIN/PACK	KG. x1/WT.x1	VOL. x1/UNIT VOL.
131703-032	■ NERO/BLACK	x1	10	0,49	mc. 0,051
131704-032	■ GRIGIO/GREY RAL7040	x1	10	0,49	mc. 0,051
131705-032	□ BIANCO/WHITE RAL9003	x1	10	0,49	mc. 0,051
131715-032	■ BLU/BLUE RAL5014	x1	10	0,49	mc. 0,051
131703-033	■ NERO/BLACK	x1	10	0,49	mc. 0,051
131704-033	■ GRIGIO/GREY RAL7040	x1	10	0,49	mc. 0,051
131705-033	□ BIANCO/WHITE RAL9003	x1	10	0,49	mc. 0,051
131715-033	■ BLU/BLUE RAL5014	x1	10	0,49	mc. 0,051

22 LOGAN-KIT VITI PER COPPIA BRACCIOLI
LOGAN_KIT SCREWS FOR PAIR ARMS

CODICE/CODE	FINITURA/FINISHING	Q. KIT	Q. MIN/PACK
117000-025	■ NERO/BLACK	x1	10

11 LOGAN-PIASTRA DI FISSAGGIO PER BRACCIOLO
LOGAN-FIXING PLATE FOR ARM

CODICE/CODE	FINITURA/FINISHING	Q. KIT	Q. MIN/PACK	KG. x1/WT.x1	VOL. x1/UNIT VOL.
131703-034	■ NERO/BLACK	x2	50	0,07	mc. 0,0013

12 LOGAN-TAPPO PER TELAIO E SCHIENALE
INNER CAPS-COVER HEAD D.22

CODICE/CODE	FINITURA/FINISHING	Q. KIT	Q. MIN/PACK	KG. x1/WT.x1	VOL. x1/UNIT VOL.
131703-029	■ NERO/BLACK	x2	20	0,025	mc. 0,001
131704-029	■ GRIGIO/GREY RAL7040	x2	20	0,025	mc. 0,001
131705-029	□ BIANCO/WHITE RAL9003	x2	20	0,025	mc. 0,001
131715-029	■ BLU/BLUE RAL5014	x2	20	0,025	mc. 0,001

13 SPTA-SNODO TAVOLETTA ANTIPANICO IN ALLUMINIO LUCIDO
SPTA-POLISHED ALUMINIUM SWIVEL SAFETY MECHANISM FOR TABLET

CODICE/CODE	FINITURA/FINISHING	Q. KIT	Q. MIN/PACK	A	B	C	KG. x1/WT.x1	VOL. x1/UNIT VOL.
111701-900	■ ALLUMINIO/ALUMINIUM DESTRO/RIGHT	x1	10	180	66	15x15	0,365	mc. 0,001
111701-901	■ ALLUMINIO/ALUMINIUM SINISTRO/LEFT	x1	10	180	66	15x15	0,365	mc. 0,001

14 TLT3-TAVOLETTA AMBIDESTRO CON PORTABICCHIERE E PORTAPENNE
TLT3--WRITING TABLET WITH CUP HOLDER AND PEN TRAY

CODICE/CODE	FINITURA/FINISHING	Q. KIT	Q. MIN/PACK	A	B	KG. x1/WT.x1	VOL. x1/UNIT VOL.
134003-041	■ NERO/BLACK	x1	10	410	300	1,05	mc. 0,036

15 VITE HILO TC + 4x14 ZN NERE
SCREW HILO TC+ 4X14 ZN BLACK

CODICE/CODE	FINITURA/FINISHING	Q. KIT
117803-120	■ NERO/BLACK	x10

16 LOGAN-COPPIA AGGANCI LATERALI MASCHIO + FEMMINA CROMATI
LOGAN-CHROME LATERAL HOOKS MALE + FEMAL WITH SCREWS

CODICE/CODE	FINITURA/FINISHING	Q. KIT	Q. MIN/PACK	KG. x1/WT.x1	VOL. x1/UNIT VOL.
113410-101	■ CROMATO/CHROME	x1	100	0,13	mc. 0,002

OPTIONAL

TAVOLETTA TLT TLT TABLET	TAVOLETTA TLT2 TLT2 TABLET	TAVOLETTA TLT3 TLT3 TABLET	TAVOLETTA BEAN BEAN TABLET	TAVOLETTA TL01 TL01 TABLET	SNODO TAVOLETTA SPT2 SPT2 MECHANISM TABLET	SNODO ANTIPANICO MECHANISM ANTIPANIC
						
VEDI/SEE PAG. 327	VEDI/SEE PAG. 327	VEDI/SEE PAG. 327	VEDI/SEE PAG. 327	VEDI/SEE PAG. 327	VEDI/SEE PAG. 326	VEDI/SEE PAG. 326

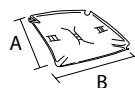
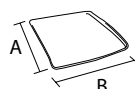
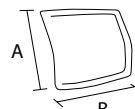
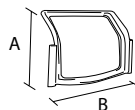

03 LOGAN-TELAIO SCHIENALE IN PLASTICA PER RETE (PORTANTE)							
LOGAN-BACK FRAME IN PLASTIC FOR MESH							
CODICE/CODE	FINITURA/FINISHING	Q.KIT	Q.MIN/PACK	A	B	KG.x1/WT.x1	VOL.x1/UNIT.VOL.
132103-084	■ NERO/BLACK	x1	10	390	500	0,58	mc. 0,088

05 LOGAN-PANNELLO SCHIENALE IN PLASTICA DA TAPPEZZARE							
LOGAN-PLASTIC PANEL BACK FOR UPHOLSTERY							
CODICE/CODE	FINITURA/FINISHING	Q.KIT	Q.MIN/PACK	A	B	KG.x1/WT.x1	VOL.x1/UNIT.VOL.
132103-086	■ NERO/BLACK	x1	20	380	420	0,90	mc. 0,005

06 LOGAN-SEDILE IN PLASTICA COLORATO A VISTA (DA TAPPEZZARE)							
LOGAN-PLASTIC SEAT COLOURED AT SIGHT (TO BE UPHOLSTERED)							
CODICE/CODE	FINITURA/FINISHING	Q.KIT	Q.MIN/PACK	A	B	KG.x1/WT.x1	VOL.x1/UNIT.VOL.
132203-082	■ NERO/BLACK	x1	10	430	460	0,86	mc. 0,01
132204-082	■ GRIGIO/GREY RAL7040	x1	10	430	460	0,86	mc. 0,01
132205-082	□ BIANCO/WHITE RAL9003	x1	10	430	460	0,86	mc. 0,01
132215-082	■ BLU/BLUE RAL5014	x1	10	430	460	0,86	mc. 0,01

07 LOGAN-SOTTOSEDILE IN PLASTICA PER TELAIO 4 GAMBE E SLITTA							
LOGAN-OUTER PLASTIC SEAT FOR FOUR LEGS AND SLIDE							
CODICE/CODE	FINITURA/FINISHING	Q.KIT	Q.MIN/PACK	A	B	KG.x1/WT.x1	VOL.x1/UNIT.VOL.
132203-080	■ NERO/BLACK	x1	20	420	450	0,51	mc. 0,007
132204-080	■ GRIGIO/GREY RAL7040	x1	20	420	450	0,51	mc. 0,007
132205-080	□ BIANCO/WHITE RAL9003	x1	20	420	450	0,51	mc. 0,007
132215-080	■ BLU/BLUE RAL5014	x1	20	420	450	0,51	mc. 0,007

+ 08 VITE / SCREW

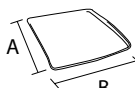

17 LOGAN-SCHIENALE IN PLASTICA COLORATO A VISTA							
LOGAN-PLASTIC BACK COLOURED AT SIGHT							
CODICE/CODE	FINITURA/FINISHING	Q.KIT	Q.MIN/PACK	A	B	KG.x1/WT.x1	VOL.x1/UNIT.VOL.
132103-083	■ NERO/BLACK	x1	10	390	500	0,82	mc. 0,088
132104-083	■ GRIGIO/GREY RAL7040	x1	10	390	500	0,82	mc. 0,088
132105-083	□ BIANCO/WHITE RAL9003	x1	10	390	500	0,82	mc. 0,088
132115-083	■ BLU/BLUE RAL5014	x1	10	390	500	0,82	mc. 0,088

06 LOGAN-SEDILE IN PLASTICA COLORATO A VISTA							
LOGAN-PLASTIC SEAT COLOURED AT SIGHT							
CODICE/CODE	FINITURA/FINISHING	Q.KIT	Q.MIN/PACK	A	B	KG.x1/WT.x1	VOL.x1/UNIT.VOL.
132203-082	■ NERO/BLACK	x1	10	430	460	0,86	mc. 0,01
132204-082	■ GRIGIO/GREY RAL7040	x1	10	430	460	0,86	mc. 0,01
132205-082	□ BIANCO/WHITE RAL9003	x1	10	430	460	0,86	mc. 0,01
132215-082	■ BLU/BLUE RAL5014	x1	10	430	460	0,86	mc. 0,01

07 LOGAN-SOTTOSEDILE IN PLASTICA PER TELAIO 4 GAMBE E SLITTA							
LOGAN-OUTER PLASTIC SEAT FOR FOUR LEGS AND SLIDE							
CODICE/CODE	FINITURA/FINISHING	Q.KIT	Q.MIN/PACK	A	B	KG.x1/WT.x1	VOL.x1/UNIT.VOL.
132203-080	■ NERO/BLACK	x1	20	420	450	0,51	mc. 0,007
132204-080	■ GRIGIO/GREY RAL7040	x1	20	420	450	0,51	mc. 0,007
132205-080	□ BIANCO/WHITE RAL9003	x1	20	420	450	0,51	mc. 0,007
132215-080	■ BLU/BLUE RAL5014	x1	20	420	450	0,51	mc. 0,007

+ 08 VITE / SCREW



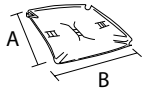
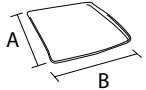
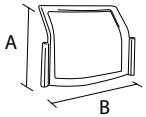
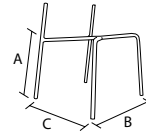
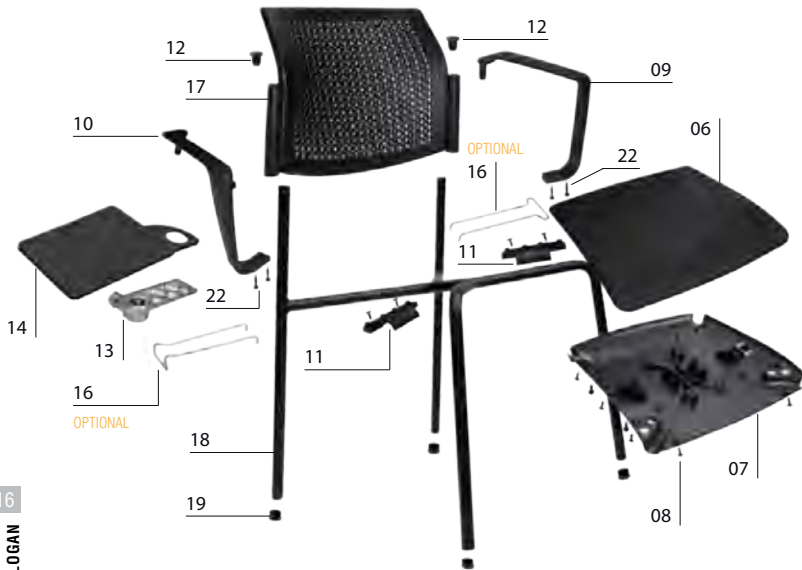

18 LOGAN-TELAIO 4 GAMBE IN TUBO D.22 SENZA TAPPI LOGAN-FIXED FOUR LEGS FRAME D.22 WITHOUT CAPS										
CODICE/CODE	FINITURA/FINISHING	Q. KIT	Q. MIN/PACK	A	B	C	KG. x1/WT.x1	VOL. x1/UNIT VOL.		
110603-059	■ NERO/BLACK	x1	80	440	530	510	2,70	mc. 0,017		
110604-059	■ GRIGIO/GREY IG2621	x1	80	440	530	510	2,70	mc. 0,017		
110610-059	■ CROMATO/CHROME	x1	80	440	530	510	2,70	mc. 0,017		

19 TI22-PUNTALE ALETTATO TONDO D.22 TI22-RIBBED INSERT FOR ROUND TUBES D.22										
CODICE/CODE	FINITURA/FINISHING	Q. KIT								
134203-220	■ NERO/BLACK	x4								

17 LOGAN-SCHIENALE IN PLASTICA COLORATO A VISTA LOGAN-PLASTIC BACK COLOURED AT SIGHT										
CODICE/CODE	FINITURA/FINISHING	Q. KIT	Q. MIN/PACK	A	B	KG. x1/WT.x1	VOL. x1/UNIT VOL.			
132103-083	■ NERO/BLACK	x1	10	390	500	0,82	mc. 0,088			
132104-083	■ GRIGIO/GREY RAL7040	x1	10	390	500	0,82	mc. 0,088			
132105-083	□ BIANCO/WHITE RAL9003	x1	10	390	500	0,82	mc. 0,088			
132115-083	■ BLU/BLUE RAL5014	x1	10	390	500	0,82	mc. 0,088			

06 LOGAN-SEDILE IN PLASTICA COLORATO A VISTA LOGAN-PLASTIC SEAT COLOURED AT SIGHT										
CODICE/CODE	FINITURA/FINISHING	Q. KIT	Q. MIN/PACK	A	B	KG. x1/WT.x1	VOL. x1/UNIT VOL.			
132203-082	■ NERO/BLACK	x1	10	430	460	0,86	mc. 0,01			
132204-082	■ GRIGIO/GREY RAL7040	x1	10	430	460	0,86	mc. 0,01			
132205-082	□ BIANCO/WHITE RAL9003	x1	10	430	460	0,86	mc. 0,01			
132215-082	■ BLU/BLUE RAL5014	x1	10	430	460	0,86	mc. 0,01			

07 LOGAN-SOTTOSEDILE IN PLASTICA PER TELAIO 4 GAMBE E SLITTA LOGAN-OUTER PLASTIC SEAT FOR FOUR LEGS AND SLIDE										
CODICE/CODE	FINITURA/FINISHING	Q. KIT	Q. MIN/PACK	A	B	KG. x1/WT.x1	VOL. x1/UNIT VOL.			
132203-080	■ NERO/BLACK	x1	20	420	450	0,51	mc. 0,007			
132204-080	■ GRIGIO/GREY RAL7040	x1	20	420	450	0,51	mc. 0,007			
132205-080	□ BIANCO/WHITE RAL9003	x1	20	420	450	0,51	mc. 0,007			
132215-080	■ BLU/BLUE RAL5014	x1	20	420	450	0,51	mc. 0,007			

08 LOGAN-SACCHETTO CON N°10 HILO TC+ 5X14 ZN NERE + N°4 PF1 - PER SEDILE LOGAN-N°10 SCREW HILO THREAD TC+ D.5X14 ZN BLACK + N°4 PF1 (SCREW FOR FIXED SEAT PANEL)										
CODICE/CODE	FINITURA/FINISHING	Q. KIT	Q. MIN/PACK							
117000-022	■ NERO/BLACK	x1	10							

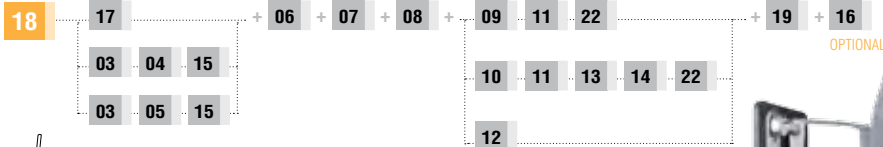

OPTIONAL 16

COPPIA AGGANCIO LATERALE
PAIR SIDE WIRE HOOKS



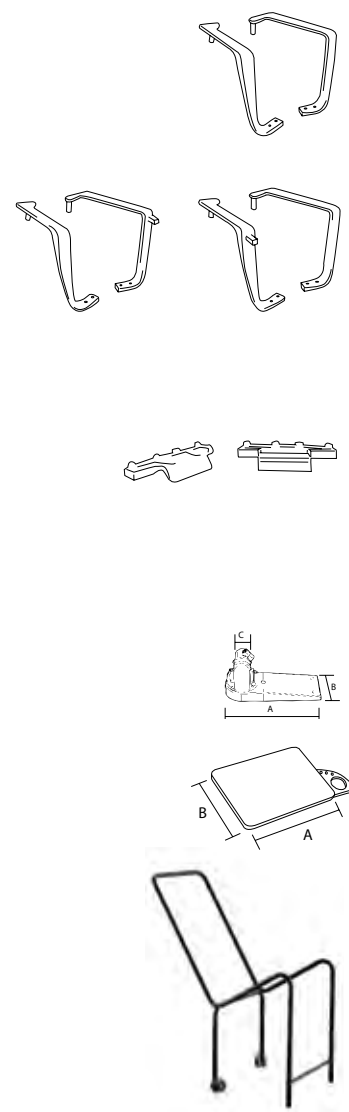

09 LOGAN-COPPIA BRACCIOLI DX/SX IN PLASTICA
LOGAN-PAIR OF PLASTIC ARMS RIGHT/LEFT

CODICE/CODE	FINITURA/FINISHING	Q. KIT	Q. MIN/PACK	KG. x1/WT.x1	VOL. x1/UNIT VOL.
131703-031	■ NERO/BLACK	x1	10	0,43	mc. 0,051
131704-031	■ GRIGIO/GREY RAL7040	x1	10	0,43	mc. 0,051
131705-031	□ BIANCO/WHITE RAL9003	x1	10	0,43	mc. 0,051
131715-031	■ BLU/BLUE RAL5014	x1	10	0,43	mc. 0,051

10 LOGAN-COPPIA BRACCIOLI CON AGGANCI PORTATAVOLETTA IN PLASTICA
LOGAN-PAIR OF PLASTIC ARMS RIGHT/LEFT WITH WRITING TABLET HOOK

CODICE/CODE	FINITURA/FINISHING	Q. KIT	Q. MIN/PACK	KG. x1/WT.x1	VOL. x1/UNIT VOL.
131703-032	■ NERO/BLACK	x1	10	0,49	mc. 0,051
131704-032	■ GRIGIO/GREY RAL7040	x1	10	0,49	mc. 0,051
131705-032	□ BIANCO/WHITE RAL9003	x1	10	0,49	mc. 0,051
131715-032	■ BLU/BLUE RAL5014	x1	10	0,49	mc. 0,051
131703-033	■ NERO/BLACK	x1	10	0,49	mc. 0,051
131704-033	■ GRIGIO/GREY RAL7040	x1	10	0,49	mc. 0,051
131705-033	□ BIANCO/WHITE RAL9003	x1	10	0,49	mc. 0,051
131715-033	■ BLU/BLUE RAL5014	x1	10	0,49	mc. 0,051

22 LOGAN-KIT VITI PER COPPIA BRACCIOLI
LOGAN_KIT SCREWS FOR PAIR ARMS

CODICE/CODE	FINITURA/FINISHING	Q. KIT	Q. MIN/PACK
117000-025	■ NERO/BLACK	x1	10

11 LOGAN-PIASTRA DI FISSAGGIO PER BRACCIOLO
LOGAN-FIXING PLATE FOR ARM

CODICE/CODE	FINITURA/FINISHING	Q. KIT	Q. MIN/PACK	KG. x1/WT.x1	VOL. x1/UNIT VOL.
131703-034	■ NERO/BLACK	x2	50	0,07	mc. 0,0013

12 LOGAN-TAPPO PER TELAIO E SCHIENALE
INNER CAPS-COVER HEAD D.22

CODICE/CODE	FINITURA/FINISHING	Q. KIT	Q. MIN/PACK	KG. x1/WT.x1	VOL. x1/UNIT VOL.
131703-029	■ NERO/BLACK	x2	20	0,025	mc. 0,001
131704-029	■ GRIGIO/GREY RAL7040	x2	20	0,025	mc. 0,001
131705-029	□ BIANCO/WHITE RAL9003	x2	20	0,025	mc. 0,001
131715-029	■ BLU/BLUE RAL5014	x2	20	0,025	mc. 0,001

13 SPTA-SNODO TAVOLETTA ANTIPANICO IN ALLUMINIO LUCIDO
SPTA-POLISHED ALUMINIUM SWIVEL SAFETY MECHANISM FOR TABLET

CODICE/CODE	FINITURA/FINISHING	Q. KIT	Q. MIN/PACK	A	B	C	KG. x1/WT.x1	VOL. x1/UNIT VOL.
111701-900	■ ALLUMINIO/ALUMINIUM DESTRO/RIGHT	x1	10	180	66	15x15	0,365	mc. 0,001
111701-901	■ ALLUMINIO/ALUMINIUM SINISTRO/LEFT	x1	10	180	66	15x15	0,365	mc. 0,001

14 TLT3-TAVOLETTA AMBIDESTRO CON PORTABICCHIERE E PORTAPENNE
TLT3--WRITING TABLET WITH CUP HOLDER AND PEN TRAY

CODICE/CODE	FINITURA/FINISHING	Q. KIT	Q. MIN/PACK	A	B	KG. x1/WT.x1	VOL. x1/UNIT VOL.
134003-041	■ NERO/BLACK	x1	10	410	300	1,05	mc. 0,036

16 LOGAN-COPPIA AGGANCI LATERALI MASCHIO + FEMMINA CROMATI
LOGAN-CHROME LATERAL HOOKS MALE + FEMAL WITH SCREWS

CODICE/CODE	FINITURA/FINISHING	Q. KIT	Q. MIN/PACK	KG. x1/WT.x1	VOL. x1/UNIT VOL.
113410-101	■ CROMATO/CHROME	x1	100	0,13	mc. 0,002

LOGAN-CARRELLO PORTASEDIE CON ACCESSORI NERO
LOGAN-TROLLEY FOR CHAIRS WITH ACCESSORIES BLACK

CODICE/CODE	FINITURA/FINISHING	Q. KIT
110803-052	■ NERO/BLACK	x1

OPTIONAL

TAVOLETTA TLT TLT TABLET	TAVOLETTA TLT2 TLT2 TABLET	TAVOLETTA TLT3 TLT3 TABLET	TAVOLETTA BEAN BEAN TABLET	TAVOLETTA TL01 TL01 TABLET	SNODO TAVOLETTA SPT2 SPT2 MECHANISM TABLET	SNODO ANTIPANICO MECHANISM ANTIPANICO
						
VEDI/SEE PAG. 327	VEDI/SEE PAG. 327	VEDI/SEE PAG. 327	VEDI/SEE PAG. 327	VEDI/SEE PAG. 327	VEDI/SEE PAG. 326	VEDI/SEE PAG. 326

4 LEGS OPTIONS:

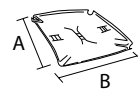
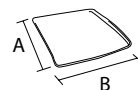
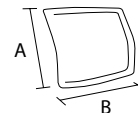
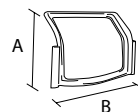

03 LOGAN-TELAIO SCHIENALE IN PLASTICA PER RETE (PORTANTE)
LOGAN-BACK FRAME IN PLASTIC FOR MESH

CODICE/CODE	FINITURA/FINISHING	Q. KIT	Q. MIN/PACK	A	B	KG. x1/WT.x1	VOL. x1/UNIT VOL.
132103-084	■ NERO/BLACK	x1	10	390	500	0,58	mc. 0,088

05 LOGAN-PANNELLO SCHIENALE IN PLASTICA DA TAPPEZZARE
LOGAN-PLASTIC PANEL BACK FOR UPHOLSTERY

CODICE/CODE	FINITURA/FINISHING	Q. KIT	Q. MIN/PACK	A	B	KG. x1/WT.x1	VOL. x1/UNIT VOL.
132103-086	■ NERO/BLACK	x1	20	380	420	0,90	mc. 0,005

06 LOGAN-SEDILE IN PLASTICA COLORATO A VISTA (DA TAPPEZZARE)
LOGAN-PLASTIC SEAT COLOURED AT SIGHT (TO BE UPHOLSTERED)

CODICE/CODE	FINITURA/FINISHING	Q. KIT	Q. MIN/PACK	A	B	KG. x1/WT.x1	VOL. x1/UNIT VOL.
132203-082	■ NERO/BLACK	x1	10	430	460	0,86	mc. 0,01
132204-082	■ GRIGIO/GREY RAL7040	x1	10	430	460	0,86	mc. 0,01
132205-082	□ BIANCO/WHITE RAL9003	x1	10	430	460	0,86	mc. 0,01
132215-082	■ BLU/BLUE RAL5014	x1	10	430	460	0,86	mc. 0,01

07 LOGAN-SOTTOSEDILE IN PLASTICA PER TELAIO 4 GAMBE E SLITTA
LOGAN-OUTER PLASTIC SEAT FOR FOUR LEGS AND SLIDE

CODICE/CODE	FINITURA/FINISHING	Q. KIT	Q. MIN/PACK	A	B	KG. x1/WT.x1	VOL. x1/UNIT VOL.
132203-080	■ NERO/BLACK	x1	20	420	450	0,51	mc. 0,007
132204-080	■ GRIGIO/GREY RAL7040	x1	20	420	450	0,51	mc. 0,007
132205-080	□ BIANCO/WHITE RAL9003	x1	20	420	450	0,51	mc. 0,007
132215-080	■ BLU/BLUE RAL5014	x1	20	420	450	0,51	mc. 0,007

15 VITE HILO TC + 4x14 ZN NERE
SCREW HILO TC+ 4X14 ZN BLACK

CODICE/CODE	FINITURA/FINISHING	Q. KIT
117803-120	■ NERO/BLACK	x10

+ **08** VITE / SCREW

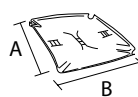
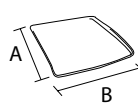
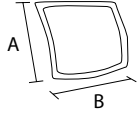
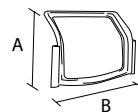

03 LOGAN-TELAIO SCHIENALE IN PLASTICA PER RETE (PORTANTE)
LOGAN-BACK FRAME IN PLASTIC FOR MESH

CODICE/CODE	FINITURA/FINISHING	Q. KIT	Q. MIN/PACK	A	B	KG. x1/WT.x1	VOL. x1/UNIT VOL.
132103-084	■ NERO/BLACK	x1	10	390	500	0,58	mc. 0,088

04 LOGAN-CORNICE SCHIENALE IN PLASTICA PER RETE
LOGAN-OPEN FRAME IN PLASTIC FOR MESH

CODICE/CODE	FINITURA/FINISHING	Q. KIT	Q. MIN/PACK	A	B	KG. x1/WT.x1	VOL. x1/UNIT VOL.
132103-085	■ NERO/BLACK	x1	20	380	420	0,30	mc. 0,005

06 LOGAN-SEDILE IN PLASTICA COLORATO A VISTA (DA TAPPEZZARE)
LOGAN-PLASTIC SEAT COLOURED AT SIGHT (TO BE UPHOLSTERED)

CODICE/CODE	FINITURA/FINISHING	Q. KIT	Q. MIN/PACK	A	B	KG. x1/WT.x1	VOL. x1/UNIT VOL.
132203-082	■ NERO/BLACK	x1	10	430	460	0,86	mc. 0,01
132204-082	■ GRIGIO/GREY RAL7040	x1	10	430	460	0,86	mc. 0,01
132205-082	□ BIANCO/WHITE RAL9003	x1	10	430	460	0,86	mc. 0,01
132215-082	■ BLU/BLUE RAL5014	x1	10	430	460	0,86	mc. 0,01

07 LOGAN-SOTTOSEDILE IN PLASTICA PER TELAIO 4 GAMBE E SLITTA
LOGAN-OUTER PLASTIC SEAT FOR FOUR LEGS AND SLIDE

CODICE/CODE	FINITURA/FINISHING	Q. KIT	Q. MIN/PACK	A	B	KG. x1/WT.x1	VOL. x1/UNIT VOL.
132203-080	■ NERO/BLACK	x1	20	420	450	0,51	mc. 0,007
132204-080	■ GRIGIO/GREY RAL7040	x1	20	420	450	0,51	mc. 0,007
132205-080	□ BIANCO/WHITE RAL9003	x1	20	420	450	0,51	mc. 0,007
132215-082	■ BLU/BLUE RAL5014	x1	20	420	450	0,51	mc. 0,007

15 VITE HILO TC + 4x14 ZN NERE
SCREW HILO TC+ 4X14 ZN BLACK

CODICE/CODE	FINITURA/FINISHING	Q. KIT
117803-120	■ NERO/BLACK	x10

+ **08** VITE / SCREW

LOGAN 4 LEGS FOR CASTORS

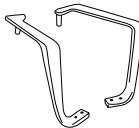
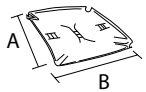
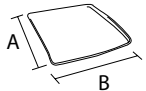
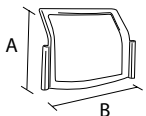
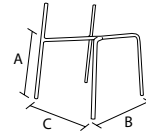

24 LOGAN-TELAIO 4 GAMBE PREDISPOSTO PER 4 RUOTE + 4 TAPPI PORTA RUOTE
LOGAN-FIXED FOUR LEGS FRAME ISSUED FOR 4 WHEELS + 4 INNER BLACK CAPS FOR CASTORS

CODICE/CODE	FINITURA/FINISHING	Q. KIT	Q. MIN/PACK	A	B	C	KG. x1/WT.x1	VOL. x1/UNIT VOL.
110603-058	■ NERO/BLACK	x1	80	440	470	510	2,70	mc. 0,017
110604-058	■ GRIGIO/GREY IG2621	x1	80	440	470	510	2,70	mc. 0,017
110610-058	■ CROMATO/CHROME	x1	80	440	470	510	2,70	mc. 0,017

25 DOPPIA RUOTA D.50 IN DESMOPAN CON PERNO MONTATO
TWIN WHEEL CASTOR D.50 DESMOPAN WITH PIVOT MOUNTED

CODICE/CODE	FINITURA/FINISHING	Q. KIT
134403-003	■ NERO/BLACK	x4

17 LOGAN-SCHIENALE IN PLASTICA COLORATO A VISTA
LOGAN-PLASTIC BACK COLOURED AT SIGHT

CODICE/CODE	FINITURA/FINISHING	Q. KIT	Q. MIN/PACK	A	B	KG. x1/WT.x1	VOL. x1/UNIT VOL.
132103-083	■ NERO/BLACK	x1	10	390	500	0,82	mc. 0,088
132104-083	■ GRIGIO/GREY RAL7040	x1	10	390	500	0,82	mc. 0,088
132105-083	□ BIANCO/WHITE RAL9003	x1	10	390	500	0,82	mc. 0,088
132115-083	■ BLU/BLUE RAL5014	x1	10	390	500	0,82	mc. 0,088

06 LOGAN-SEDILE IN PLASTICA COLORATO A VISTA
LOGAN-PLASTIC SEAT COLOURED AT SIGHT

CODICE/CODE	FINITURA/FINISHING	Q. KIT	Q. MIN/PACK	A	B	KG. x1/WT.x1	VOL. x1/UNIT VOL.
132203-082	■ NERO/BLACK	x1	10	430	460	0,86	mc. 0,01
132204-082	■ GRIGIO/GREY RAL7040	x1	10	430	460	0,86	mc. 0,01
132205-082	□ BIANCO/WHITE RAL9003	x1	10	430	460	0,86	mc. 0,01
132215-082	■ BLU/BLUE RAL5014	x1	10	430	460	0,86	mc. 0,01

07 LOGAN-SOTTOSEDILE IN PLASTICA PER TELAIO 4 GAMBE E SLITTA
LOGAN-OUTER PLASTIC SEAT FOR FOUR LEGS AND SLIDE

CODICE/CODE	FINITURA/FINISHING	Q. KIT	Q. MIN/PACK	A	B	KG. x1/WT.x1	VOL. x1/UNIT VOL.
132203-080	■ NERO/BLACK	x1	20	420	450	0,51	mc. 0,007
132204-080	■ GRIGIO/GREY RAL7040	x1	20	420	450	0,51	mc. 0,007
132205-080	□ BIANCO/WHITE RAL9003	x1	20	420	450	0,51	mc. 0,007
132215-080	■ BLU/BLUE RAL5014	x1	20	420	450	0,51	mc. 0,007

08 LOGAN-SACCHETTO CON N°10 HILO TC+ 5X14 ZN NERE + N°4 PF1 - PER SEDILE
LOGAN-N°10 SCREW HILO THREAD TC+ D.5X14 ZN BLACK + N°4 PF1 (SCREW FOR FIXED SEAT PANEL)

CODICE/CODE	FINITURA/FINISHING	Q. KIT	Q. MIN/PACK
117000-022	■ NERO/BLACK	x1	10

09 LOGAN-COPPIA BRACCIOLI DX/SX IN PLASTICA
LOGAN-PAIR OF PLASTIC ARMS RIGHT/LEFT

CODICE/CODE	FINITURA/FINISHING	Q. KIT	Q. MIN/PACK	KG. x1/WT.x1	VOL. x1/UNIT VOL.
131703-031	■ NERO/BLACK	x1	10	0,43	mc. 0,051
131704-031	■ GRIGIO/GREY RAL7040	x1	10	0,43	mc. 0,051
131705-031	□ BIANCO/WHITE RAL9003	x1	10	0,43	mc. 0,051
131715-031	■ BLU/BLUE RAL5014	x1	10	0,43	mc. 0,051

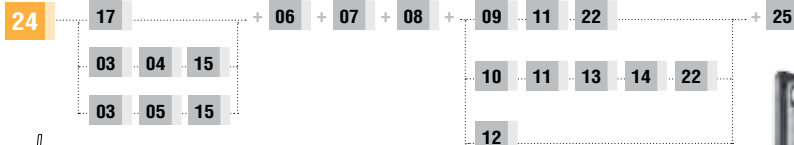

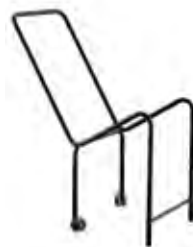
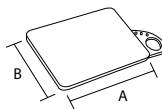
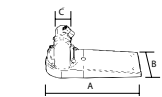
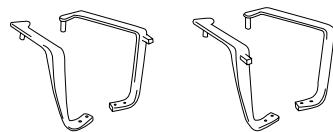

10 LOGAN-COPPIA BRACCIOLI CON AGGANCI PORTATAVOLETTA IN PLASTICA
LOGAN-PAIR OF PLASTIC ARMS RIGHT/LEFT WITH WRITING TABLET HOOK

CODICE/CODE	FINITURA/FINISHING	Q. KIT	Q. MIN/PACK		KG. x1/WT.x1	VOL. x1/UNIT VOL.
131703-032	■ NERO/BLACK	x1	10	left + right writing tablet hook	0,49	mc. 0,051
131704-032	■ GRIGIO/GREY RAL7040	x1	10	left + right writing tablet hook	0,49	mc. 0,051
131705-032	□ BIANCO/WHITE RAL9003	x1	10	left + right writing tablet hook	0,49	mc. 0,051
131715-032	■ BLU/BLUE RAL5014	x1	10	left + right writing tablet hook	0,49	mc. 0,051
131703-033	■ NERO/BLACK	x1	10	right + left writing tablet hook	0,49	mc. 0,051
131704-033	■ GRIGIO/GREY RAL7040	x1	10	right + left writing tablet hook	0,49	mc. 0,051
131705-033	□ BIANCO/WHITE RAL9003	x1	10	right + left writing tablet hook	0,49	mc. 0,051
131715-033	■ BLU/BLUE RAL5014	x1	10	right + left writing tablet hook	0,49	mc. 0,051

22 LOGAN-KIT VITI PER COPPIA BRACCIOLI
LOGAN_KIT SCREWS FOR PAIR ARMS

CODICE/CODE	FINITURA/FINISHING	Q. KIT	Q. MIN/PACK
117000-025	■ NERO/BLACK	x1	10

11 LOGAN-PIASTRA DI FISSAGGIO PER BRACCIOLO
LOGAN-FIXING PLATE FOR ARM

CODICE/CODE	FINITURA/FINISHING	Q. KIT	Q. MIN/PACK	KG. x1/WT.x1	VOL. x1/UNIT VOL.
131703-034	■ NERO/BLACK	x2	50	0,07	mc. 0,0013

12 LOGAN-TAPPO PER TELAIO E SCHIENALE
INNER CAPS-COVER HEAD D.22

CODICE/CODE	FINITURA/FINISHING	Q. KIT	Q. MIN/PACK	KG. x1/WT.x1	VOL. x1/UNIT VOL.
131703-029	■ NERO/BLACK	x2	20	0,025	mc. 0,001
131704-029	■ GRIGIO/GREY RAL7040	x2	20	0,025	mc. 0,001
131705-029	□ BIANCO/WHITE RAL9003	x2	20	0,025	mc. 0,001
131715-029	■ BLU/BLUE RAL5014	x2	20	0,025	mc. 0,001

13 SPTA-SNODO TAVOLETTA ANTIPANICO IN ALLUMINIO LUCIDO
SPTA-POLISHED ALUMINIUM SWIVEL SAFETY MECHANISM FOR TABLET

CODICE/CODE	FINITURA/FINISHING	Q. KIT	Q. MIN/PACK	A	B	C	KG. x1/WT.x1	VOL. x1/UNIT VOL.
111701-900	■ ALLUMINIO/ALUMINIUM DESTRO/RIGHT	x1	10	180	66	15x15	0,365	mc. 0,001
111701-901	■ ALLUMINIO/ALUMINIUM SINISTRO/LEFT	x1	10	180	66	15x15	0,365	mc. 0,001

14 TLT3-TAVOLETTA AMBIDESTRO CON PORTABICCHIERE E PORTAPENNE
TLT3-WRITING TABLET WITH CUP HOLDER AND PEN TRAY

CODICE/CODE	FINITURA/FINISHING	Q. KIT	Q. MIN/PACK	A	B	KG. x1/WT.x1	VOL. x1/UNIT VOL.
134003-041	■ NERO/BLACK	x1	10	410	300	1,05	mc. 0,036

LOGAN-CARRELLO PORTASEDIE CON ACCESSORI NERO
LOGAN-TROLLEY FOR CHAIRS WITH ACCESSORIES BLACK

CODICE/CODE	FINITURA/FINISHING	Q. KIT
110803-052	■ NERO/BLACK	x1

OPTIONAL

TAVOLETTA TLT
TLT TABLET



VEDI/SEE PAG. 327

TAVOLETTA TLT2
TLT2 TABLET



VEDI/SEE PAG. 327

TAVOLETTA TLT3
TLT3 TABLET



VEDI/SEE PAG. 327

TAVOLETTA BEAN
BEAN TABLET



VEDI/SEE PAG. 327

TAVOLETTA TL01
TL01 TABLET



VEDI/SEE PAG. 327

SNODO TAVOLETTA SPT2
SPT2 MECHANISM TABLET



VEDI/SEE PAG. 326

SNODO ANTIPANICO
MECHANISM ANTIPANICO



VEDI/SEE PAG. 326

4 LEGS FOR CASTORS OPTIONS:

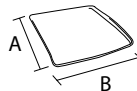
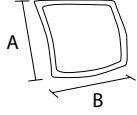
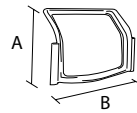
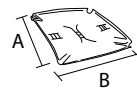
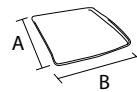
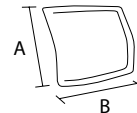
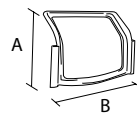

03 LOGAN-TELAIO SCHIENALE IN PLASTICA PER RETE (PORTANTE)
LOGAN-BACK FRAME IN PLASTIC FOR MESH

CODICE/CODE	FINITURA/FINISHING	Q.KIT	Q.MIN/PACK	A	B	KG.x1/WT.x1	VOL.x1/UNIT VOL.
132103-084	■ NERO/BLACK	x1	10	390	500	0,58	mc. 0,088

05 LOGAN-PANNELLO SCHIENALE IN PLASTICA DA TAPPEZZARE
LOGAN-PLASTIC PANEL BACK FOR UPHOLSTERY

CODICE/CODE	FINITURA/FINISHING	Q.KIT	Q.MIN/PACK	A	B	KG.x1/WT.x1	VOL.x1/UNIT VOL.
132103-086	■ NERO/BLACK	x1	20	380	420	0,90	mc. 0,005

06 LOGAN-SEDILE IN PLASTICA COLORATO A VISTA (DA TAPPEZZARE)
LOGAN-PLASTIC SEAT COLOURED AT SIGHT (TO BE UPHOLSTERED)

CODICE/CODE	FINITURA/FINISHING	Q.KIT	Q.MIN/PACK	A	B	KG.x1/WT.x1	VOL.x1/UNIT VOL.
132203-082	■ NERO/BLACK	x1	10	430	460	0,86	mc. 0,01
132204-082	■ GRIGIO/GREY RAL7040	x1	10	430	460	0,86	mc. 0,01
132205-082	□ BIANCO/WHITE RAL9003	x1	10	430	460	0,86	mc. 0,01
132215-082	■ BLU/BLUE RAL5014	x1	10	430	460	0,86	mc. 0,01

07 LOGAN-SOTTOSEDILE IN PLASTICA PER TELAIO 4 GAMBE E SLITTA
LOGAN-OUTER PLASTIC SEAT FOR FOUR LEGS AND SLIDE

CODICE/CODE	FINITURA/FINISHING	Q.KIT	Q.MIN/PACK	A	B	KG.x1/WT.x1	VOL.x1/UNIT VOL.
132203-080	■ NERO/BLACK	x1	20	420	450	0,51	mc. 0,007
132204-080	■ GRIGIO/GREY RAL7040	x1	20	420	450	0,51	mc. 0,007
132205-080	□ BIANCO/WHITE RAL9003	x1	20	420	450	0,51	mc. 0,007
132215-080	■ BLU/BLUE RAL5014	x1	20	420	450	0,51	mc. 0,007

15 VITE HILO TC + 4x14 ZN NERE
SCREW HILO TC+ 4X14 ZN BLACK

CODICE/CODE	FINITURA/FINISHING	Q.KIT
117803-120	■ NERO/BLACK	x10

+ **08** VITE / SCREW

03 LOGAN-TELAIO SCHIENALE IN PLASTICA PER RETE (PORTANTE)
LOGAN-BACK FRAME IN PLASTIC FOR MESH

CODICE/CODE	FINITURA/FINISHING	Q.KIT	Q.MIN/PACK	A	B	KG.x1/WT.x1	VOL.x1/UNIT VOL.
132103-084	■ NERO/BLACK	x1	10	390	500	0,58	mc. 0,088

04 LOGAN-CORNICE SCHIENALE IN PLASTICA PER RETE
LOGAN-OPEN FRAME IN PLASTIC FOR MESH

CODICE/CODE	FINITURA/FINISHING	Q.KIT	Q.MIN/PACK	A	B	KG.x1/WT.x1	VOL.x1/UNIT VOL.
132103-085	■ NERO/BLACK	x1	20	380	420	0,30	mc. 0,005

06 LOGAN-SEDILE IN PLASTICA COLORATO A VISTA (DA TAPPEZZARE)
LOGAN-PLASTIC SEAT COLOURED AT SIGHT (TO BE UPHOLSTERED)

CODICE/CODE	FINITURA/FINISHING	Q.KIT	Q.MIN/PACK	A	B	KG.x1/WT.x1	VOL.x1/UNIT VOL.
132203-082	■ NERO/BLACK	x1	10	430	460	0,86	mc. 0,01
132204-082	■ GRIGIO/GREY RAL7040	x1	10	430	460	0,86	mc. 0,01
132205-082	□ BIANCO/WHITE RAL9003	x1	10	430	460	0,86	mc. 0,01
132215-082	■ BLU/BLUE RAL5014	x1	10	430	460	0,86	mc. 0,01

07 LOGAN-SOTTOSEDILE IN PLASTICA PER TELAIO 4 GAMBE E SLITTA
LOGAN-OUTER PLASTIC SEAT FOR FOUR LEGS AND SLIDE

CODICE/CODE	FINITURA/FINISHING	Q.KIT	Q.MIN/PACK	A	B	KG.x1/WT.x1	VOL.x1/UNIT VOL.
132203-080	■ NERO/BLACK	x1	20	420	450	0,51	mc. 0,007
132204-080	■ GRIGIO/GREY RAL7040	x1	20	420	450	0,51	mc. 0,007
132205-080	□ BIANCO/WHITE RAL9003	x1	20	420	450	0,51	mc. 0,007
132215-082	■ BLU/BLUE RAL5014	x1	20	420	450	0,51	mc. 0,007

15 VITE HILO TC + 4x14 ZN NERE
SCREW HILO TC+ 4X14 ZN BLACK

CODICE/CODE	FINITURA/FINISHING	Q.KIT
117803-120	■ NERO/BLACK	x10

+ **08** VITE / SCREW

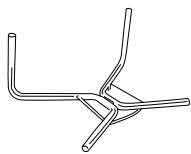
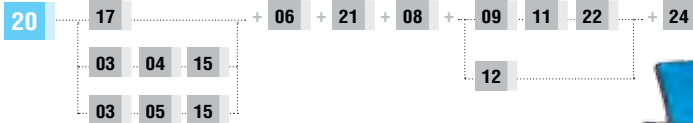
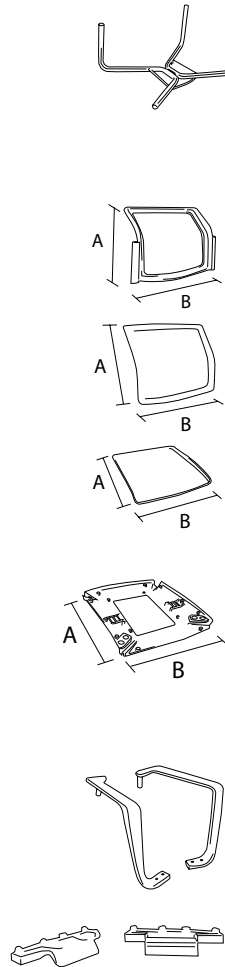
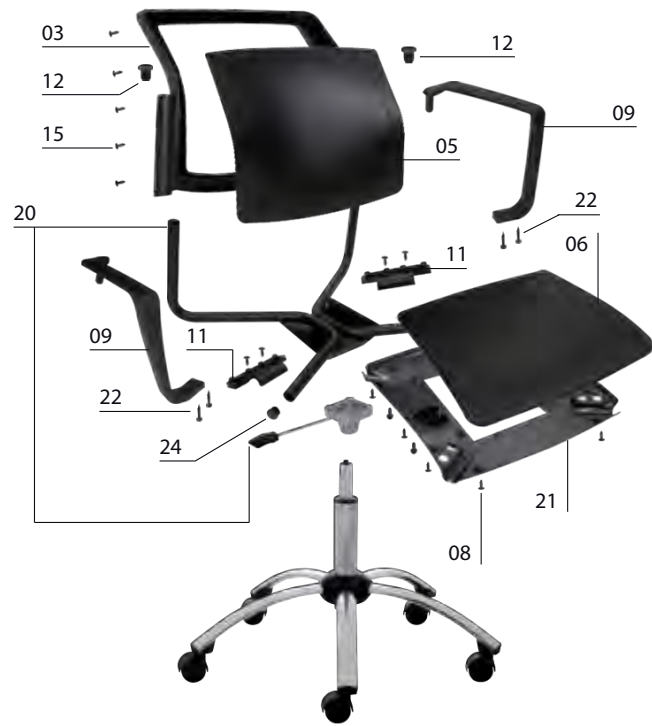

20	LOGAN-TELAIO PER GIREVOLE COMANDO A GAS SENZA TAPPI LOGAN-SWIVEL FRAME WITH GAS LEVER WITHOUT CAPS	CODICE/CODE 110903-024	FINITURA/FINISHING ■ NERO/BLACK	Q. KIT x1	Q. MIN/PACK 80	KG. x1/WT.x1 2,55	VOL. x1/UNIT VOL. mc. 0,046	
12	LOGAN-TAPPO PER TELAIO E SCHIENALE INNER CAPS-COVER HEAD D.22	CODICE/CODE 131703-029 131704-029 131705-029 131715-029	FINITURA/FINISHING ■ NERO/BLACK ■ GRIGIO/GREY RAL7040 □ BIANCO/WHITE RAL9003 ■ BLU/BLUE RAL5014	Q. KIT x2 x2 x2 x2	Q. MIN/PACK 20 20 20 20	KG. x1/WT.x1 0,025 0,025 0,025 0,025	VOL. x1/UNIT VOL. mc. 0,001 mc. 0,001 mc. 0,001 mc. 0,001	
03	LOGAN-TELAIO SCHIENALE IN PLASTICA PER RETE (PORTANTE) LOGAN-BACK FRAME IN PLASTIC FOR MESH	CODICE/CODE 132103-084	FINITURA/FINISHING ■ NERO/BLACK	Q. KIT x1	Q. MIN/PACK 10	A B 390 500	KG. x1/WT.x1 0,58	VOL. x1/UNIT VOL. mc. 0,088
05	LOGAN-PANNELLO SCHIENALE IN PLASTICA DA TAPPEZZARE LOGAN-PLASTIC PANEL BACK FOR UPHOLSTERY	CODICE/CODE 132103-086	FINITURA/FINISHING ■ NERO/BLACK	Q. KIT x1	Q. MIN/PACK 20	A B 380 420	KG. x1/WT.x1 0,90	VOL. x1/UNIT VOL. mc. 0,005
06	LOGAN-SEDILE IN PLASTICA COLORATO A VISTA LOGAN-PLASTIC SEAT COLOURED AT SIGHT	CODICE/CODE 132203-082 132204-082 132205-082 132215-082	FINITURA/FINISHING ■ NERO/BLACK ■ GRIGIO/GREY RAL7040 □ BIANCO/WHITE RAL9003 ■ BLU/BLUE RAL5014	Q. KIT x1 x1 x1 x1	Q. MIN/PACK 10 10 10 10	A B 430 460 430 460 430 460 430 460	KG. x1/WT.x1 0,86 0,86 0,86 0,86	VOL. x1/UNIT VOL. mc. 0,01 mc. 0,01 mc. 0,01 mc. 0,01
21	LOGAN-SOTTOSEDILE ESTERNO IN PLASTICA PER TELAIO PANCA E GIREVOLE LOGAN-OUTER PLASTIC SEAT FOR SWIVEL AND BENCH	CODICE/CODE 132203-081 132204-081 132205-081 132215-081	FINITURA/FINISHING ■ NERO/BLACK ■ GRIGIO/GREY RAL7040 □ BIANCO/WHITE RAL9003 ■ BLU/BLUE RAL5014	Q. KIT x1 x1 x1 x1	Q. MIN/PACK 20 20 20 20	A B 420 450 420 450 420 450 420 450	KG. x1/WT.x1 0,47 0,47 0,47 0,47	VOL. x1/UNIT VOL. mc. 0,007 mc. 0,007 mc. 0,007 mc. 0,007
08	LOGAN-SACCHETTO CON N°10 HILO TC+ 5X14 ZN NERE + N°4 PF1 - PER SEDILE LOGAN-N°10 SCREW HILO THREAD TC+ D.5X14 ZN BLACK + N°4 PF1 (SCREW FOR FIXED SEAT PANEL)	CODICE/CODE 117000-022	FINITURA/FINISHING ■ NERO/BLACK	Q. KIT x1	Q. MIN/PACK 10			
09	LOGAN-COPPIA BRACCIOLI DX/SX IN PLASTICA LOGAN-PAIR OF PLASTIC ARMS RIGHT/LEFT	CODICE/CODE 131703-031 131704-031 131705-031 131715-031	FINITURA/FINISHING ■ NERO/BLACK ■ GRIGIO/GREY RAL7040 □ BIANCO/WHITE RAL9003 ■ BLU/BLUE RAL5014	Q. KIT x1 x1 x1 x1	Q. MIN/PACK 10 10 10 10	KG. x1/WT.x1 0,43 0,43 0,43 0,43	VOL. x1/UNIT VOL. mc. 0,051 mc. 0,051 mc. 0,051 mc. 0,051	
11	LOGAN-PIASTRA DI FISSAGGIO PER BRACCIOLO LOGAN-FIXING PLATE FOR ARM	CODICE/CODE 131703-034	FINITURA/FINISHING ■ NERO/BLACK	Q. KIT x2	Q. MIN/PACK 50	KG. x1/WT.x1 0,07	VOL. x1/UNIT VOL. mc. 0,0013	
15	VITE HILO TC + 4x14 ZN NERE SCREW HILO TC+ 4X14 ZN BLACK	CODICE/CODE 117803-120	FINITURA/FINISHING ■ NERO/BLACK	Q. KIT x10				
22	LOGAN-KIT VITI PER COPPIA BRACCIOLI LOGAN_KIT SCREWS FOR PAIR ARMS	CODICE/CODE 117000-025	FINITURA/FINISHING ■ NERO/BLACK	Q. KIT x1	Q. MIN/PACK 10			
24	TC22-TAPPO COPRITESTA ALETTATO D.22 NERO TC22-INNER CAPS-COVER HEAD D.22 BLACK	CODICE/CODE 134103-220	FINITURA/FINISHING ■ NERO/BLACK	Q. KIT x2				

SWIVEL OPTIONS:

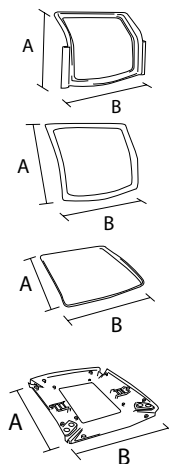

03 LOGAN-TELAIO SCHIENALE IN PLASTICA PER RETE (PORTANTE)

LOGAN-BACK FRAME IN PLASTIC FOR MESH

CODICE/CODE	FINITURA/FINISHING	Q.KIT	Q.MIN/PACK	A	B	KG.x1/WT.x1	VOL.x1/UNIT VOL.
132103-084	■ NERO/BLACK	x1	10	390	500	0,58	mc. 0,088

04 LOGAN-CORNICE SCHIENALE IN PLASTICA PER RETE

LOGAN-OPEN FRAME IN PLASTIC FOR MESH

CODICE/CODE	FINITURA/FINISHING	Q.KIT	Q.MIN/PACK	A	B	KG.x1/WT.x1	VOL.x1/UNIT VOL.
132103-085	■ NERO/BLACK	x1	20	380	420	0,30	mc. 0,005

06 LOGAN-SEDILE IN PLASTICA COLORATO A VISTA (DA TAPPEZZARE)

LOGAN-PLASTIC SEAT COLOURED AT SIGHT (TO BE UPHOLSTERED)

CODICE/CODE	FINITURA/FINISHING	Q.KIT	Q.MIN/PACK	A	B	KG.x1/WT.x1	VOL.x1/UNIT VOL.
132203-082	■ NERO/BLACK	x1	10	430	460	0,86	mc. 0,01
132204-082	■ GRIGIO/GREY RAL7040	x1	10	430	460	0,86	mc. 0,01
132205-082	□ BIANCO/WHITE RAL9003	x1	10	430	460	0,86	mc. 0,01
132215-082	■ BLU/BLUE RAL5014	x1	10	430	460	0,86	mc. 0,01

21 LOGAN-SOTTOSEDILE ESTERNO IN PLASTICA PER TELAIO PANCA E GIREVOLE

LOGAN-OUTER PLASTIC SEAT FOR SWIVEL AND BENCH

CODICE/CODE	FINITURA/FINISHING	Q.KIT	Q.MIN/PACK	A	B	KG.x1/WT.x1	VOL.x1/UNIT VOL.
132203-081	■ NERO/BLACK	x1	20	420	450	0,47	mc. 0,007
132204-081	■ GRIGIO/GREY RAL7040	x1	20	420	450	0,47	mc. 0,007
132205-081	□ BIANCO/WHITE RAL9003	x1	20	420	450	0,47	mc. 0,007
132215-081	■ BLU/BLUE RAL5014	x1	20	420	450	0,47	mc. 0,007

+ 22 + 15 VITI / SCREWS

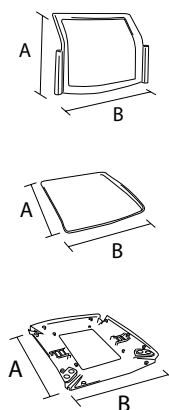

17 LOGAN-SCHIENALE IN PLASTICA COLORATO A VISTA

LOGAN-PLASTIC BACK COLOURED AT SIGHT

CODICE/CODE	FINITURA/FINISHING	Q.KIT	Q.MIN/PACK	A	B	KG.x1/WT.x1	VOL.x1/UNIT VOL.
132103-083	■ NERO/BLACK	x1	10	390	500	0,82	mc. 0,088
132104-083	■ GRIGIO/GREY RAL7040	x1	10	390	500	0,82	mc. 0,088
132105-083	□ BIANCO/WHITE RAL9003	x1	10	390	500	0,82	mc. 0,088
132115-083	■ BLU/BLUE RAL5014	x1	10	390	500	0,82	mc. 0,088

06 LOGAN-SEDILE IN PLASTICA COLORATO A VISTA

LOGAN-PLASTIC SEAT COLOURED AT SIGHT

CODICE/CODE	FINITURA/FINISHING	Q.KIT	Q.MIN/PACK	A	B	KG.x1/WT.x1	VOL.x1/UNIT VOL.
132203-082	■ NERO/BLACK	x1	10	430	460	0,86	mc. 0,01
132204-082	■ GRIGIO/GREY RAL7040	x1	10	430	460	0,86	mc. 0,01
132205-082	□ BIANCO/WHITE RAL9003	x1	10	430	460	0,86	mc. 0,01
132215-082	■ BLU/BLUE RAL5014	x1	10	430	460	0,86	mc. 0,01

21 LOGAN-SOTTOSEDILE ESTERNO IN PLASTICA PER TELAIO PANCA E GIREVOLE

LOGAN-OUTER PLASTIC SEAT FOR SWIVEL AND BENCH

CODICE/CODE	FINITURA/FINISHING	Q.KIT	Q.MIN/PACK	A	B	KG.x1/WT.x1	VOL.x1/UNIT VOL.
132203-081	■ NERO/BLACK	x1	20	420	450	0,47	mc. 0,007
132204-081	■ GRIGIO/GREY RAL7040	x1	20	420	450	0,47	mc. 0,007
132205-081	□ BIANCO/WHITE RAL9003	x1	20	420	450	0,47	mc. 0,007
132215-081	■ BLU/BLUE RAL5014	x1	20	420	450	0,47	mc. 0,007

+ 22 VITE / SCREW

LOGAN BENCH



PER I COMPONENTI DELLA PANCA VAI A PAG. 337
FOR THE BENCH COMPONENTS GO TO PAGE 337

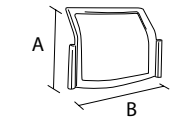
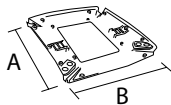
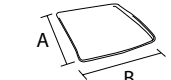

23	LOGAN-TELAIO PER PANCA SENZA TAPPI LOGAN-BENCH FRAME CAPS EXCLUDED	CODICE/CODE 110703-024	FINITURA/FINISHING ■ NERO/BLACK	Q. KIT x1	Q. MIN/PACK 80	KG. x1/WT.x1 2,20	VOL. x1/UNIT VOL. mc. 0,046	
12	LOGAN-TAPPO PER TELAIO E SCHIENALE INNER CAPS-COVER HEAD D.22	CODICE/CODE 131703-029 131704-029 131705-029 131715-029	FINITURA/FINISHING ■ NERO/BLACK ■ GRIGIO/GREY RAL7040 □ BIANCO/WHITE RAL9003 ■ BLU/BLUE RAL5014	Q. KIT x2 x2 x2 x2	Q. MIN/PACK 20 20 20 20	KG. x1/WT.x1 0,025 0,025 0,025 0,025	VOL. x1/UNIT VOL. mc. 0,001 mc. 0,001 mc. 0,001 mc. 0,001	
06	LOGAN-SEDILE IN PLASTICA COLORATO A VISTA LOGAN-PLASTIC SEAT COLOURED AT SIGHT	CODICE/CODE 132203-082 132204-082 132205-082 132215-082	FINITURA/FINISHING ■ NERO/BLACK ■ GRIGIO/GREY RAL7040 □ BIANCO/WHITE RAL9003 ■ BLU/BLUE RAL5014	Q. KIT x1 x1 x1 x1	Q. MIN/PACK 10 10 10 10	A B 430 460 430 460 430 460 430 460	KG. x1/WT.x1 0,86 0,86 0,86 0,86	VOL. x1/UNIT VOL. mc. 0,01 mc. 0,01 mc. 0,01 mc. 0,01
21	LOGAN-SOTTOSEDILE ESTERNO IN PLASTICA PER TELAIO PANCA E GIREVOLE LOGAN-OUTER PLASTIC SEAT FOR SWIVEL AND BENCH	CODICE/CODE 132203-081 132204-081 132205-081 132215-081	FINITURA/FINISHING ■ NERO/BLACK ■ GRIGIO/GREY RAL7040 □ BIANCO/WHITE RAL9003 ■ BLU/BLUE RAL5014	Q. KIT x1 x1 x1 x1	Q. MIN/PACK 20 20 20 20	A B 420 450 420 450 420 450 420 450	KG. x1/WT.x1 0,47 0,47 0,47 0,47	VOL. x1/UNIT VOL. mc. 0,007 mc. 0,007 mc. 0,007 mc. 0,007
08	LOGAN-SACCHETTO CON N°10 HILO TC+ 5X14 ZN NERE + N°4 PF1 - PER SEDILE LOGAN-N°10 SCREW HILO THREAD TC+ D.5X14 ZN BLACK + N°4 PF1 (SCREW FOR FIXED SEAT PANEL)	CODICE/CODE 117000-022	FINITURA/FINISHING ■ NERO/BLACK	Q. KIT x1	Q. MIN/PACK 10			
17	LOGAN-SCHIENALE IN PLASTICA COLORATO A VISTA LOGAN-PLASTIC BACK COLOURED AT SIGHT	CODICE/CODE 132103-083 132104-083 132105-083 132115-083	FINITURA/FINISHING ■ NERO/BLACK ■ GRIGIO/GREY RAL7040 □ BIANCO/WHITE RAL9003 ■ BLU/BLUE RAL5014	Q. KIT x1 x1 x1 x1	Q. MIN/PACK 10 10 10 10	A B 390 500 390 500 390 500 390 500	KG. x1/WT.x1 0,82 0,82 0,82 0,82	VOL. x1/UNIT VOL. mc. 0,088 mc. 0,088 mc. 0,088 mc. 0,088
24	TC22-TAPPO COPRITESTA ALETTATO D. 22 NERO TC22-INNER CAPS-COVER HEAD D.22 BLACK	CODICE/CODE 134103-220	FINITURA/FINISHING ■ NERO/BLACK	Q. KIT x2				
09	LOGAN-COPPIA BRACCIOLI DX/SX IN PLASTICA LOGAN-PAIR OF PLASTIC ARMS RIGHT/LEFT	CODICE/CODE 131703-031 131704-031 131705-031 131715-031	FINITURA/FINISHING ■ NERO/BLACK ■ GRIGIO/GREY RAL7040 □ BIANCO/WHITE RAL9003 ■ BLU/BLUE RAL5014	Q. KIT x1 x1 x1 x1	Q. MIN/PACK 10 10 10 10	KG. x1/WT.x1 0,43 0,43 0,43 0,43	VOL. x1/UNIT VOL. mc. 0,051 mc. 0,051 mc. 0,051 mc. 0,051	
11	LOGAN-PIASTRA DI FISSAGGIO PER BRACCIOLO LOGAN-FIXING PLATE FOR ARM	CODICE/CODE 131703-034	FINITURA/FINISHING ■ NERO/BLACK	Q. KIT x2	Q. MIN/PACK 50	KG. x1/WT.x1 0,07	VOL. x1/UNIT VOL. mc. 0,0013	
22	LOGAN-KIT VITI PER COPPIA BRACCIOLI LOGAN_KIT SCREWS FOR PAIR ARMS	CODICE/CODE 117000-025	FINITURA/FINISHING ■ NERO/BLACK	Q. KIT x1	Q. MIN/PACK 10			

OPTIONAL GAMBA LEG OPTIONAL

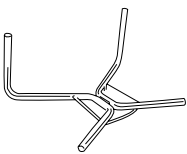

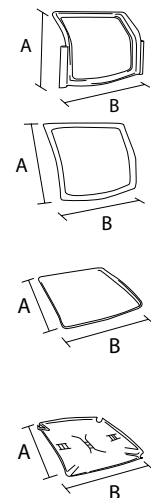
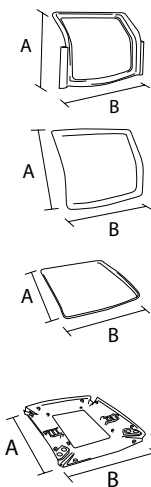

03	LOGAN-TELAIO SCHIENALE IN PLASTICA PER RETE (PORTANTE) LOGAN-BACK FRAME IN PLASTIC FOR MESH						
CODICE/CODE	FINITURA/FINISHING	Q. KIT	Q. MIN/PACK	A	B	KG. x1/WT.x1	VOL. x1/UNIT VOL.
132103-084	■ NERO/BLACK	x1	10	390	500	0,58	mc. 0,088
05	LOGAN-PANNELLO SCHIENALE IN PLASTICA DA TAPPEZZARE LOGAN-PLASTIC PANEL BACK FOR UPHOLSTERY						
CODICE/CODE	FINITURA/FINISHING	Q. KIT	Q. MIN/PACK	A	B	KG. x1/WT.x1	VOL. x1/UNIT VOL.
132103-086	■ NERO/BLACK	x1	20	380	420	0,90	mc. 0,005
06	LOGAN-SEDILE IN PLASTICA COLORATO A VISTA (DA TAPPEZZARE) LOGAN-PLASTIC SEAT COLOURED AT SIGHT (TO BE UPHOLSTERED)						
CODICE/CODE	FINITURA/FINISHING	Q. KIT	Q. MIN/PACK	A	B	KG. x1/WT.x1	VOL. x1/UNIT VOL.
132203-082	■ NERO/BLACK	x1	10	430	460	0,86	mc. 0,01
132204-082	■ GRIGIO/GREY RAL7040	x1	10	430	460	0,86	mc. 0,01
132205-082	□ BIANCO/WHITE RAL9003	x1	10	430	460	0,86	mc. 0,01
132215-082	■ BLU/BLUE RAL5014	x1	10	430	460	0,86	mc. 0,01
21	LOGAN-SOTTOSEDILE ESTERNO IN PLASTICA PER TELAIO PANCA E GIREVOLE LOGAN-OUTER PLASTIC SEAT FOR SWIVEL AND BENCH						
CODICE/CODE	FINITURA/FINISHING	Q. KIT	Q. MIN/PACK	A	B	KG. x1/WT.x1	VOL. x1/UNIT VOL.
132203-081	■ NERO/BLACK	x1	20	420	450	0,47	mc. 0,007
132204-081	■ GRIGIO/GREY RAL7040	x1	20	420	450	0,47	mc. 0,007
132205-081	□ BIANCO/WHITE RAL9003	x1	20	420	450	0,47	mc. 0,007
132215-081	■ BLU/BLUE RAL5014	x1	20	420	450	0,47	mc. 0,007
15	VITE HILO TC + 4x14 ZN NERE SCREW HILO TC+ 4X14 ZN BLACK						
CODICE/CODE	FINITURA/FINISHING	Q. KIT					
117803-120	■ NERO/BLACK	x10					

+ **08** VITE / SCREW

03	LOGAN-TELAIO SCHIENALE IN PLASTICA PER RETE (PORTANTE) LOGAN-BACK FRAME IN PLASTIC FOR MESH						
CODICE/CODE	FINITURA/FINISHING	Q. KIT	Q. MIN/PACK	A	B	KG. x1/WT.x1	VOL. x1/UNIT VOL.
132103-084	■ NERO/BLACK	x1	10	390	500	0,58	mc. 0,088
04	LOGAN-CORNICE SCHIENALE IN PLASTICA PER RETE LOGAN-OPEN FRAME IN PLASTIC FOR MESH						
CODICE/CODE	FINITURA/FINISHING	Q. KIT	Q. MIN/PACK	A	B	KG. x1/WT.x1	VOL. x1/UNIT VOL.
132103-085	■ NERO/BLACK	x1	20	380	420	0,30	mc. 0,005
06	LOGAN-SEDILE IN PLASTICA COLORATO A VISTA (DA TAPPEZZARE) LOGAN-PLASTIC SEAT COLOURED AT SIGHT (TO BE UPHOLSTERED)						
CODICE/CODE	FINITURA/FINISHING	Q. KIT	Q. MIN/PACK	A	B	KG. x1/WT.x1	VOL. x1/UNIT VOL.
132203-082	■ NERO/BLACK	x1	10	430	460	0,86	mc. 0,01
132204-082	■ GRIGIO/GREY RAL7040	x1	10	430	460	0,86	mc. 0,01
132205-082	□ BIANCO/WHITE RAL9003	x1	10	430	460	0,86	mc. 0,01
132215-082	■ BLU/BLUE RAL5014	x1	10	430	460	0,86	mc. 0,01
21	LOGAN-SOTTOSEDILE ESTERNO IN PLASTICA PER TELAIO PANCA E GIREVOLE LOGAN-OUTER PLASTIC SEAT FOR SWIVEL AND BENCH						
CODICE/CODE	FINITURA/FINISHING	Q. KIT	Q. MIN/PACK	A	B	KG. x1/WT.x1	VOL. x1/UNIT VOL.
132203-081	■ NERO/BLACK	x1	20	420	450	0,47	mc. 0,007
132204-081	■ GRIGIO/GREY RAL7040	x1	20	420	450	0,47	mc. 0,007
132205-081	□ BIANCO/WHITE RAL9003	x1	20	420	450	0,47	mc. 0,007
132215-081	■ BLU/BLUE RAL5014	x1	20	420	450	0,47	mc. 0,007
15	VITE HILO TC + 4x14 ZN NERE SCREW HILO TC+ 4X14 ZN BLACK						
CODICE/CODE	FINITURA/FINISHING	Q. KIT					
117803-120	■ NERO/BLACK	x10					

+ **08** VITE / SCREW





SQUARE

SLIDE

4 LEGS

4 LEGS FOR CASTORS

SWIVEL

BENCH



EN 16139

BIFMA

SQUARE 4 LEGS

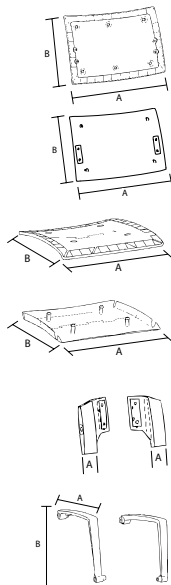
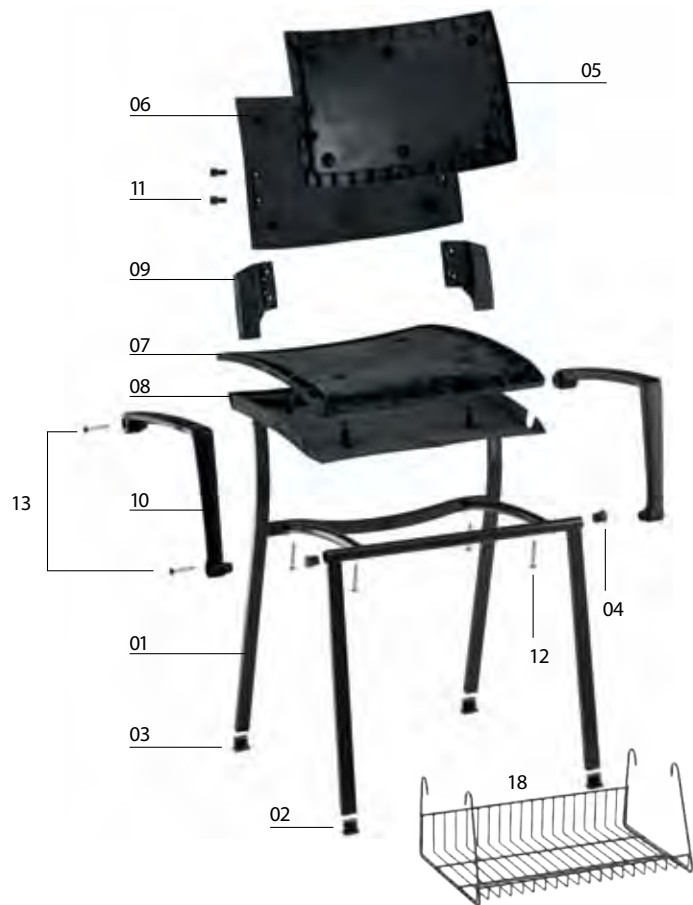
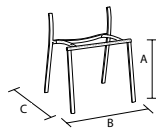

SQUARE

128

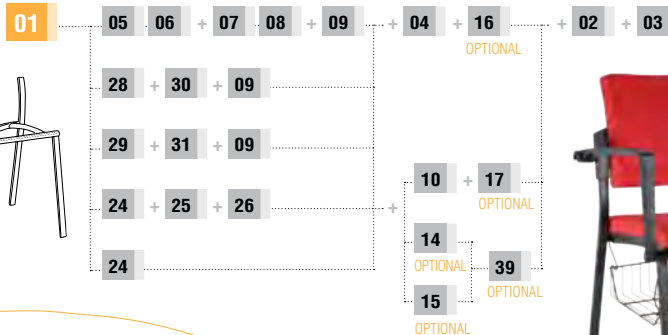

01 SQUARE-TELAIO PER SEDIA FISSA SENZA TAPPISOTTOPIEDE MONTATI

SQUARE - FIXED FRAME FOR CHAIR WITHOUT CAPS		Q. KIT	Q. MIN/PACK	A	B	C	KG. x1/WT.x1	VOL. x1/UNIT VOL.
CODICE/CODE	FINITURA/FINISHING							
112603-025	■ NERO/BLACK	x1	80	450	500	500	3,20	mc. 0,003
112604-025	■ GRIGIO/GREY	x1	80	450	500	500	3,20	mc. 0,003
112610-025	■ CROMATO/CHROME	x1	80	450	500	500	3,20	mc. 0,003

02 PUNTALE ALETTATO RETTANGOLARE 25X15

RIBBED RECTANGULAR INSERT 25X15		Q. KIT	Q. MIN/PACK	A	B	C	KG. x1/WT.x1	VOL. x1/UNIT VOL.
CODICE/CODE	FINITURA/FINISHING							
134203-020	■ NERO/BLACK	x2						
134204-020	■ GRIGIO/GREY	x2						

03 PUNTALE ALETTATO INCLINATO RETTANGOLARE 25X15

RIBBED RECTANGULAR INCLINED INSERT 25X15		Q. KIT	Q. MIN/PACK	A	B	C	KG. x1/WT.x1	VOL. x1/UNIT VOL.
CODICE/CODE	FINITURA/FINISHING							
134203-023	■ NERO/BLACK	x2						
134204-023	■ GRIGIO/GREY	x2						

04 TAPPO COPRITESTA Ø22 PER SEDIA SENZA BRACCIOLI

COVER HEAD CAP Ø22 FOR CHAIR WITHOUT ARMS		Q. KIT	Q. MIN/PACK	A	B	C	KG. x1/WT.x1	VOL. x1/UNIT VOL.
CODICE/CODE	FINITURA/FINISHING							
134103-220	■ NERO/BLACK	x2						
134104-220	■ GRIGIO/GREY	x2						

05 SQUARE-SHI-SCHIENALE INTERNO IN PLASTICA

SQUARE-SHI-INNER PLASTIC BACK		Q. KIT	Q. MIN/PACK	A	B	C	KG. x1/WT.x1	VOL. x1/UNIT VOL.
CODICE/CODE	FINITURA/FINISHING							
132103-006	■ NERO/BLACK	x1	20	440	290		0,55	mc. 0,004

06 SQUARE-SHE-SCHIENALE ESTERNO IN PLASTICA

SQUARE-SHE-OUTER PLASTIC BACK		Q. KIT	Q. MIN/PACK	A	B	C	KG. x1/WT.x1	VOL. x1/UNIT VOL.
CODICE/CODE	FINITURA/FINISHING							
132103-005	■ NERO/BLACK	x1	20	425	280		0,37	mc. 0,004
132104-026	■ GRIGIO/GREY	x1	20	425	280		0,37	mc. 0,004

07 SQUARE-SEDILE INTERNO IN PLASTICA

SQUARE-INNER PLASTIC SEAT		Q. KIT	Q. MIN/PACK	A	B	C	KG. x1/WT.x1	VOL. x1/UNIT VOL.
CODICE/CODE	FINITURA/FINISHING							
132203-007	■ NERO/BLACK	x1	20	440	460		0,90	mc. 0,005

08 SQUARE-SEDILE ESTERNO IN PLASTICA

SQUARE-OUTER PLASTIC SEAT		Q. KIT	Q. MIN/PACK	A	B	C	KG. x1/WT.x1	VOL. x1/UNIT VOL.
CODICE/CODE	FINITURA/FINISHING							
132203-006	■ NERO/BLACK	x1	20	430	450		0,53	mc. 0,008
132204-026	■ GRIGIO/GREY	x1	20	430	450		0,53	mc. 0,008

09 SQUARE-COPPIA SUPPORTI SCHIENALE IN PLASTICA

SQUARE-PLASTIC PAIR OF SUPPORTS FOR BACK		Q. KIT	Q. MIN/PACK	A	B	C	KG. x1/WT.x1	VOL. x1/UNIT VOL.
CODICE/CODE	FINITURA/FINISHING							
134003-087	■ NERO/BLACK	x1	40	25x15			0,16	mc. 0,0002
134004-022	■ GRIGIO/GREY	x1	40	25x15			0,16	mc. 0,0002

10 SQUARE-COPPIA BRACCIOLI IN PLASTICA

SQUARE-PLASTIC PAIR ARMS		Q. KIT	Q. MIN/PACK	A	B	C	KG. x1/WT.x1	VOL. x1/UNIT VOL.
CODICE/CODE	FINITURA/FINISHING							
131703-005	■ NERO/BLACK	x1	10	360	260		0,70	mc. 0,006
131704-005	■ GRIGIO/GREY	x1	10	360	260		0,70	mc. 0,006

11 VITE TESTA CILINDRICA A CROCE M6X16 ZINCATA

SCREW CYLINDRICAL CROSS HEAD M6X16 ZINC		Q. KIT	Q. MIN/PACK	A	B	C	KG. x1/WT.x1	VOL. x1/UNIT VOL.
CODICE/CODE	FINITURA/FINISHING							
117711-191	■ ZINCATA/ZINC	x4						

12 VITE TESTA SVASATA A CROCE M6X30 ZINCATA (VITE PER FISSAGGIO SEDILE)

SCREW FLARED HEAD M6X30 ZINC (SCREW FOR SIX SEAT)		Q. KIT	Q. MIN/PACK	A	B	C	KG. x1/WT.x1	VOL. x1/UNIT VOL.
CODICE/CODE	FINITURA/FINISHING							
117711-192	■ ZINCATA/ZINC	x4						

13 VITE AUTOFILETTANTE 5,5X45 TESTA SVASATA A CROCE

SCREW AUTO-THREADING 5,5X45 FLARED CROSS		Q. KIT	Q. MIN/PACK	A	B	C	KG. x1/WT.x1	VOL. x1/UNIT VOL.
CODICE/CODE	FINITURA/FINISHING							
117811-168	■ ZINCATA/ZINC	x4						

18 SQUARE-CESTELLO PORTARIVISTE

SQUARE-BASKET TRAY		Q. KIT	Q. MIN/PACK	A	B	C	KG. x1/WT.x1	VOL. x1/UNIT VOL.
CODICE/CODE	FINITURA/FINISHING							
113403-003	■ NERO/BLACK	x1						

4 LEGS OPTIONS:



28	SCHIENALE IN MULTISTRATO FAGGIO BACK IN PLYWOOD BEECH					
CODICE/CODE	FINITURA/FINISHING	Q. KIT	Q. MIN/PACK	A	B	KG. x1/WT.x1
122107-010	FAGGIO/BEECH WOOD	x1	15	425	280	1,30

30	SQUARE SDLF-SEDILE MULTISTRATO FAGGIO VERNICIATO + VITI SQUARE SDLF-PAINTED BEECH WOOD SEAT WITH SCREWS					
CODICE/CODE	FINITURA/FINISHING	Q. KIT	Q. MIN/PACK	A	B	KG. x1/WT.x1
122207-015	FAGGIO/BEECH WOOD	x1	15	422	280	1,65



29	SCHIENALE TAPPEZZATO CUIOIO BLACK UPHOLTERED IN BLACK LEATHER					
CODICE/CODE	FINITURA/FINISHING	Q. KIT	Q. MIN/PACK	A	B	KG. x1/WT.x1
142103-001	CUOIO/LEATHER	x1	15	430	450	1,05

31	SQUARE SDCNR-SEDILE TAPPEZZATO CUIOIO NERO + VITI SQUARE SDCNR-BLACK LEATHER SEAT WITH SCREWS					
CODICE/CODE	FINITURA/FINISHING	Q. KIT	Q. MIN/PACK	A	B	KG. x1/WT.x1
142203-001	CUOIO/LEATHER	x1	15	422	280	1,36



24	SQUARE-COPPIA SEDILE SCHIENALE IN PLASTICA COLORATO SQUARE-PLASTIC SEAT/BACK COLOURED AT SIGHT								
CODICE/CODE	FINITURA/FINISHING	Q. KIT	Q. MIN/PACK	A	B	C	D	KG. x1/WT.x1	VOL. x1/UNIT VOL.
134003-088	NERO/BLACK	x1	10	450	440	500	300	1,62	mc. 0,012
134004-023	GRIGIO/GREY RAL7040	x1	10	450	440	500	300	1,62	mc. 0,012
134002-023	ROSSO/RED PPL42	x1	10	450	440	500	300	1,62	mc. 0,012
134015-023	BLU/BLUE RAL5002	x1	10	450	440	500	300	1,62	mc. 0,012
134007-023	ARANCIO/ORANGE PPL22	x1	10	450	440	500	300	1,62	mc. 0,012
134005-023	BEIGE/BEIGE PPL09	x1	10	450	440	500	300	1,62	mc. 0,012



25	PANNELLO SCHIENALE DA TAPPEZZARE PANEL BACK FOR UPHOLSTERY						
CODICE/CODE	FINITURA/FINISHING	Q. KIT	Q. MIN/PACK	A	B	KG. x1/WT.x1	VOL. x1/UNIT VOL.
132103-046	NERO/BLACK	x1	20	390	310	0,50	mc. 0,004

26	PANNELLO SEDILE DA TAPPEZZARE PANEL SEAT FOR UPHOLSTERY						
CODICE/CODE	FINITURA/FINISHING	Q. KIT	Q. MIN/PACK	A	B	KG. x1/WT.x1	VOL. x1/UNIT VOL.
132203-046	NERO/BLACK	x1	20	400	450	0,60	mc. 0,004

27	VITE AUTOFILETT. 5X14 PER PANNELLO SCHIENALE E SEDILI DA TAPPEZZARE SCREW AUTO-THREAD 5X14 FOR UPHOLSTERY BACK PANEL	
CODICE/CODE	FINITURA/FINISHING	Q. KIT
117803-156	NERO/BLACK	x4+4 schienale + sedile/back + seat

OPTIONAL 14/15

BRACCIOLO DESTRO/SINISTRO CON GANCIO PORTATAVOLETTA
RIGHT/LEFT ARM WITH ATTACHMENT FOR TABLET



131703-009 DESTRO/RIGHT ■ NERO/BLACK
131703-006 SINISTRO/LEFT ■ NERO/BLACK
131704-003 DESTRO/RIGHT ■ GRIGIO/GREY
131704-004 SINISTRO/LEFT ■ GRIGIO/GREY

14	15	Q. KIT	Q. MIN/PACK	KG. x1/WT.x1	VOL. x1/UNIT VOL.
x1	x1	10	10	0,70	mc. 0,006

OPTIONAL 16/17/39

AGGANCIAMENTO LATERALE MASCHIO+FEMMINA IN PLASTICA + 2 VITI
PLASTIC LATERAL HOOK MALE+FEMALE AND 2 SCREWS



134003-130 ■ NERO/BLACK 134003-131 ■ NERO/BLACK 134003-138 ■ NERO/BLACK

16	17	39	Q. KIT	Q. MIN/PACK	KG. x1/WT.x1	VOL. x1/UNIT VOL.
x1	x1	x1	100	100	0,03	0,0001

OPTIONAL

TAVOLETTA TLT TLT TABLET	TAVOLETTA TLT2 TLT2 TABLET	TAVOLETTA TLT3 TLT3 TABLET	TAVOLETTA BEAN BEAN TABLET	TAVOLETTA TL01 TL01 TABLET	SNODO TAVOLETTA SPT2 SPT2 MECHANISM TABLET	SNODO ANTIPANICO MECHANISM ANTIPANIC
						
VEDI/SEE PAG. 327	VEDI/SEE PAG. 327	VEDI/SEE PAG. 327	VEDI/SEE PAG. 327	VEDI/SEE PAG. 327	VEDI/SEE PAG. 326	VEDI/SEE PAG. 326

SQUARE 4 LEGS FOR CASTORS

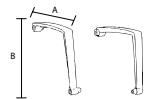
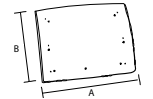
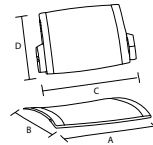
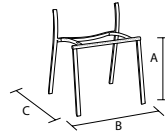

22 TELAIO PER SEDIA 4 GAMBE PREDISPOSTO PER 4 RUOTE + 4 TAPPI PORTA RUOTE									
FRAME FOR CHAIR ISSUED FOR 4 WHEELS + 4 INNER BLACK CAPS FOR CASTORS									
CODICE/CODE	FINITURA/FINISHING	Q.KIT	Q.MIN/PACK	A	B	C	KG.x1/WT.x1	VOL.x1/UNIT VOL.	
112603-027	■ NERO/BLACK	x1	80	450	500	500	3,10	mc. 0,003	
112604-027	■ GRIGIO/GREY	x1	80	450	500	500	3,10	mc. 0,003	
112610-027	■ CROMATO/CHROME	x1	80	450	500	500	3,10	mc. 0,003	

04 TAPPO COPRITESTA Ø22 PER SEDIA SENZA BRACCIOLI									
COVER HEAD CAP Ø22 FOR CHAIR WITHOUT ARMS									
CODICE/CODE	FINITURA/FINISHING	Q.KIT							
134103-220	■ NERO/BLACK	x2							
134104-220	■ GRIGIO/GREY	x2							

24 SQUARE-COPPIA SEDILE SCHIENALE IN PLASTICA COLORATO									
SQUARE-PLASTIC SEAT/BACK COLOURED AT SIGHT									
CODICE/CODE	FINITURA/FINISHING	Q.KIT	Q.MIN/PACK	A	B	C	D	KG.x1/WT.x1	VOL.x1/UNIT VOL.
134003-088	■ NERO/BLACK	x1	10	450	440	500	300	1,62	mc. 0,012
134004-023	■ GRIGIO/GREY	x1	10	450	440	500	300	1,62	mc. 0,012
134002-023	■ ROSSO/RED	x1	10	450	440	500	300	1,62	mc. 0,012
134015-023	■ BLU/BLUE	x1	10	450	440	500	300	1,62	mc. 0,012
134007-023	■ ARANCIO/ORANGE	x1	10	450	440	500	300	1,62	mc. 0,012
134005-023	■ BEIGE/BEIGE	x1	10	450	440	500	300	1,62	mc. 0,012

25 PANNELLO SCHIENALE DA TAPPEZZARE									
PANEL BACK FOR UPHOLSTERY									
CODICE/CODE	FINITURA/FINISHING	Q.KIT	Q.MIN/PACK	A	B				
132103-046	■ NERO/BLACK	x1	20	390	310				

26 PANNELLO SEDILE DA TAPPEZZARE									
PANEL SEAT FOR UPHOLSTERY									
CODICE/CODE	FINITURA/FINISHING	Q.KIT	Q.MIN/PACK	A	B				
132203-046	■ NERO/BLACK	x1	20	400	450				

10 SQUARE-COPPIA BRACCIOLI IN PLASTICA									
SQUARE-PLASTIC PAIR ARMS									
CODICE/CODE	FINITURA/FINISHING	Q.KIT	Q.MIN/PACK	A	B				
131703-005	■ NERO/BLACK	x1	10	360	260				
131704-005	■ GRIGIO/GREY	x1	10	360	260				

27 VITE AUTOFILETT. 5X14 PER PANNELLO SCHIENALE E SEDILE DA TAPPEZZARE									
SCREW AUTO-THREAD 5X14 FOR UPHOLSTERY BACK AND SEAT PANEL									
CODICE/CODE	FINITURA/FINISHING	Q.KIT							
117803-156	■ NERO/BLACK	x4+4	schienale + sedile/back + seat						

23 DOPPIA RUOTA Ø36 IN PA (RICOPERTA PUR)									
PA TWIN WHEEL CASTOR Ø36 (COVERED WITH PUR)									
CODICE/CODE	FINITURA/FINISHING	Q.KIT							
134403-001	■ NERO/BLACK	x4							

23 GAMBO GODRONATO Ø8 ZINCATO									
ZINC PLATED KNURED Ø8 STEM									
CODICE/CODE	FINITURA/FINISHING	Q.KIT							
117911-300	■ ZINCATA/ZINC	x4							

22 05 06 + 07 08 + 09 + 04 + 23

28 + 30 + 09

29 + 31 + 09

24 + 25 + 26

24

10

14

15

OPTIONAL



OPTIONAL 25/26/27

PANNELLO SCHIENALE E SEDILE DA TAPPEZZARE + VITE
PANEL BACK AND SEAT FOR UPHOLSTERY AND SCREW

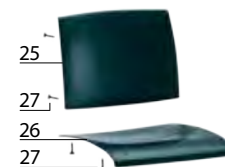

OPTIONAL 14/15

BRACCIOLO DESTRO/SINISTRO CON GANCIO PORTATAVOLETTA
RIGHT/LEFT ARM WITH ATTACHMENT FOR TABLET



131703-009 DESTRO/RIGHT ■ NERO/BLACK
131703-006 SINISTRO/LEFT ■ NERO/BLACK
131704-003 DESTRO/RIGHT ■ GRIGIO/GREY
131704-004 SINISTRO/LEFT ■ GRIGIO/GREY

14	15	Q.KIT	Q.MIN/PACK	KG.x1/WT.x1	VOL.x1/UNIT VOL.
		x1	10	0,70	mc. 0,006

4 LEGS FOR CASTORS OPTIONS:

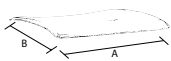
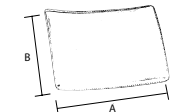
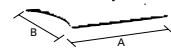
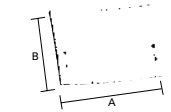
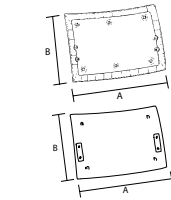

05	SQUARE-SHI-SCHIENALE INTERNO IN PLASTICA SQUARE-SHI-INNER PLASTIC BACK						
CODICE/CODE	FINITURA/FINISHING	Q. KIT	Q. MIN/PACK	A	B	KG. x1/WT.x1	VOL. x1/UNIT VOL.
132103-006	■ NERO/BLACK	x1	20	440	290	0,55	mc. 0,004

06	SQUARE-SHE-SCHIENALE ESTERNO IN PLASTICA SQUARE-SHE-OUTER PLASTIC BACK						
CODICE/CODE	FINITURA/FINISHING	Q. KIT	Q. MIN/PACK	A	B	KG. x1/WT.x1	VOL. x1/UNIT VOL.
132103-005	■ NERO/BLACK	x1	20	425	280	0,37	mc. 0,004
132104-026	■ GRIGIO/GREY	x1	20	425	280	0,37	mc. 0,004

07	SQUARE-SEDILO INTERNO IN PLASTICA SQUARE-INNER PLASTIC SEAT						
CODICE/CODE	FINITURA/FINISHING	Q. KIT	Q. MIN/PACK	A	B	KG. x1/WT.x1	VOL. x1/UNIT VOL.
132203-007	■ NERO/BLACK	x1	20	440	460	0,90	mc. 0,005

08	SQUARE-SEDILO ESTERNO IN PLASTICA SQUARE-OUTER PLASTIC SEAT						
CODICE/CODE	FINITURA/FINISHING	Q. KIT	Q. MIN/PACK	A	B	KG. x1/WT.x1	VOL. x1/UNIT VOL.
132203-006	■ NERO/BLACK	x1	20	430	450	0,53	mc. 0,008
132204-026	■ GRIGIO/GREY	x1	20	430	450	0,53	mc. 0,008

09	SQUARE-COPPIA SUPPORTI SCHIENALE IN PLASTICA SQUARE-PLASTIC PAIR OF SUPPORTS FOR BACK						
CODICE/CODE	FINITURA/FINISHING	Q. KIT	Q. MIN/PACK	A	KG. x1/WT.x1	VOL. x1/UNIT VOL.	
134003-087	■ NERO/BLACK	x1	40	25x15		0,16	mc. 0,0002
134004-022	■ GRIGIO/GREY	x1	40	25x15		0,16	mc. 0,0002

+ 11 + 12 + 13 VITI / SCREWS

28	SCHIENALE IN MULTISTRATO FAGGIO BACK IN PLYWOOD BEECH					
CODICE/CODE	FINITURA/FINISHING	Q. KIT	Q. MIN/PACK	A	B	KG. x1/WT.x1
122107-010	■ FAGGIO/BEECH WOOD	x1	15	425	280	1,30

30	SQUARE SDLF-SEDILO MULTISTRATO FAGGIO VERNICIATO + VITI SQUARE SDLF-PAINTED BEECH WOOD SEAT WITH SCREWS					
CODICE/CODE	FINITURA/FINISHING	Q. KIT	Q. MIN/PACK	A	B	KG. x1/WT.x1
122207-015	■ FAGGIO/BEECH WOOD	x1	15	422	280	1,65

29	SCHIENALE TAPPEZZATO CUOIO BLACK UPHOLTERED IN BLACK LEATHER					
CODICE/CODE	FINITURA/FINISHING	Q. KIT	Q. MIN/PACK	A	B	KG. x1/WT.x1
142103-001	■ CUOIO/LEATHER	x1	15	430	450	1,05

31	SQUARE SDCNR-SEDILO TAPPEZZATO CUOIO NERO + VITI SQUARE SDCNR-BLACK LEATHER SEAT WITH SCREWS					
CODICE/CODE	FINITURA/FINISHING	Q. KIT	Q. MIN/PACK	A	B	KG. x1/WT.x1
142203-001	■ CUOIO/LEATHER	x1	15	422	280	1,36

	SQUARE-CARRELLO PORTASEDIE CON ACCESSORI SQUARE-TROLLEY FOR CHAIRS WITH ACCESSORIES					
CODICE/CODE	FINITURA/FINISHING					
112603-039	■ NERO/BLACK					

SQUARE SLIDE

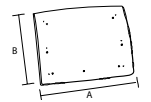
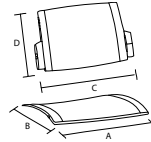

132
SQUARE

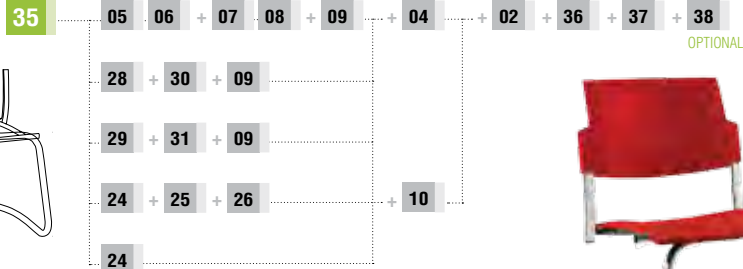

35		BASE SLITTA		SLIDE BASES							
CODICE/CODE	FINITURA/FINISHING	Q. KIT	Q. MIN/PACK	A	KG. x1/WT.x1	VOL. x1/UNIT VOL.					
110503-013	■ NERO/BLACK	x1	80	450	6,50	mc. 0,03					
110504-017	■ GRIGIO/GREY	x1	80	450	6,50	mc. 0,03					
110510-016	■ CROMATO/CHROME	x1	80	450	6,50	mc. 0,03					

36		P2P PINZA DUE PIOLI POLITENE NERA		P2P TWO-PINS PLIER IN BLACK POLYTHENE							
CODICE/CODE	FINITURA/FINISHING	Q. KIT									
134003-003	■ NERO/BLACK	x4									

37		TAPPO COPRITESTA ALETTATO D.25 NERO		RIBBED INSERT D.25 BLACK							
CODICE/CODE	FINITURA/FINISHING	Q. KIT									
134103-250	■ NERO/BLACK	x2									

38		PIEDINO ANTIRIBALTAMENTO IN PLASTICA NERO		PLASTIC BLACK FEET ANTI-UPSETTING							
CODICE/CODE	FINITURA/FINISHING	Q. KIT	Q. MIN/PACK	A	KG. x1/WT.x1	VOL. x1/UNIT VOL.					
134303-006	■ NERO/BLACK	x2	100		0,025	mc. 0,0001					

24		SQUARE-COPPIA SEDILE SCHIENALE IN PLASTICA COLORATO		SQUARE-PLASTIC SEAT/BACK COLOURED AT SIGHT							
CODICE/CODE	FINITURA/FINISHING	Q. KIT	Q. MIN/PACK	A	B	C	D	KG. x1/WT.x1	VOL. x1/UNIT VOL.		
134003-088	■ NERO/BLACK	x1	10	450	440	500	300	1,62	mc. 0,012		
134004-023	■ GRIGIO/GREY	x1	10	450	440	500	300	1,62	mc. 0,012		
134002-023	■ ROSSO/RED	x1	10	450	440	500	300	1,62	mc. 0,012		
134015-023	■ BLU/BLUE	x1	10	450	440	500	300	1,62	mc. 0,012		
134007-023	■ ARANCIO/ORANGE	x1	10	450	440	500	300	1,62	mc. 0,012		
134005-023	■ BEIGE/BEIGE	x1	10	450	440	500	300	1,62	mc. 0,012		

25		PANNELLO SCHIENALE DA TAPPEZZARE		PANEL BACK FOR UPHOLSTERY							
CODICE/CODE	FINITURA/FINISHING	Q. KIT	Q. MIN/PACK	A	B	KG. x1/WT.x1	VOL. x1/UNIT VOL.				
132103-046	■ NERO/BLACK	x1	20	390	310	0,50	mc. 0,004				

26		PANNELLO SEDILE DA TAPPEZZARE		PANEL SEAT FOR UPHOLSTERY							
CODICE/CODE	FINITURA/FINISHING	Q. KIT	Q. MIN/PACK	A	B	KG. x1/WT.x1	VOL. x1/UNIT VOL.				
132203-046	■ NERO/BLACK	x1	20	400	450	0,60	mc. 0,004				

27		VITE AUTOFILETT. 5X14 PER PANNELLO SCHIENALE E SEDILE DA TAPPEZZARE		SCREW AUTO-THREAD 5X14 FOR UPHOLSTERY BACK AND SEAT PANEL							
CODICE/CODE	FINITURA/FINISHING	Q. KIT									
117803-156	■ NERO/BLACK	x4+4	schienale + sedile/back + seat								

02		PUNTALE ALETTATO RETTANGOLARE 25X15		RIBBED RECTANGULAR INSERT 25X15							
CODICE/CODE	FINITURA/FINISHING	Q. KIT									
134203-020	■ NERO/BLACK	x2									
134204-020	■ GRIGIO/GREY	x2									

04		TAPPO COPRITESTA Ø22 PER SEDIA SENZA BRACCIOLI		COVER HEAD CAP Ø22 FOR CHAIR WITHOUT ARMS							
CODICE/CODE	FINITURA/FINISHING	Q. KIT									
134103-220	■ NERO/BLACK	x2									
134104-220	■ GRIGIO/GREY	x2									

10		SQUARE-COPPIA BRACCIOLI IN PLASTICA		SQUARE-PLASTIC PAIR ARMS							
CODICE/CODE	FINITURA/FINISHING	Q. KIT	Q. MIN/PACK	A	B	KG. x1/WT.x1	VOL. x1/UNIT VOL.				
131703-005	■ NERO/BLACK	x1	10	360	260	0,70	mc. 0,006				
131704-005	■ GRIGIO/GREY	x1	10	360	260	0,70	mc. 0,006				

OPTIONAL 38
PIEDINO ANTIRIBALTAMENTO
FEET ANTI-UPSETTING



OPTIONAL 25/26/27
PANNELLO SCHIENALE E SEDILE DA TAPPEZZARE + VITE
PANEL BACK AND SEAT FOR UPHOLSTERY AND SCREW



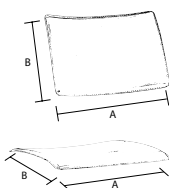
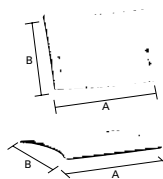
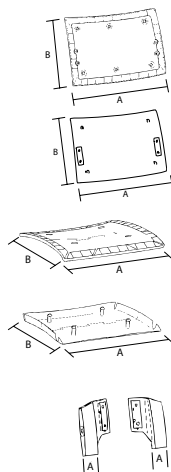

05 SQUARE-SHI-SCHIENALE INTERNO IN PLASTICA							
SQUARE-SHI-INNER PLASTIC BACK							
CODICE/CODE	FINITURA/FINISHING	Q. KIT	Q. MIN/PACK	A	B	KG. x1/WT.x1	VOL. x1/UNIT VOL.
132103-006	■ NERO/BLACK	x1	20	440	290	0,55	mc. 0,004

06 SQUARE-SHE-SCHIENALE ESTERNO IN PLASTICA							
SQUARE-SHE-OUTER PLASTIC BACK							
CODICE/CODE	FINITURA/FINISHING	Q. KIT	Q. MIN/PACK	A	B	KG. x1/WT.x1	VOL. x1/UNIT VOL.
132103-005	■ NERO/BLACK	x1	20	425	280	0,37	mc. 0,004
132104-026	■ GRIGIO/GREY	x1	20	425	280	0,37	mc. 0,004

07 SQUARE-SEDILO INTERNO IN PLASTICA							
SQUARE-INNER PLASTIC SEAT							
CODICE/CODE	FINITURA/FINISHING	Q. KIT	Q. MIN/PACK	A	B	KG. x1/WT.x1	VOL. x1/UNIT VOL.
132203-007	■ NERO/BLACK	x1	20	440	460	0,90	mc. 0,005

08 SQUARE-SEDILO ESTERNO IN PLASTICA							
SQUARE-OUTER PLASTIC SEAT							
CODICE/CODE	FINITURA/FINISHING	Q. KIT	Q. MIN/PACK	A	B	KG. x1/WT.x1	VOL. x1/UNIT VOL.
132203-006	■ NERO/BLACK	x1	20	430	450	0,53	mc. 0,008
132204-026	■ GRIGIO/GREY	x1	20	430	450	0,53	mc. 0,008

09 SQUARE-COPPIA SUPPORTI SCHIENALE IN PLASTICA							
SQUARE-PLASTIC PAIR OF SUPPORTS FOR BACK							
CODICE/CODE	FINITURA/FINISHING	Q. KIT	Q. MIN/PACK	A	B	KG. x1/WT.x1	VOL. x1/UNIT VOL.
134003-087	■ NERO/BLACK	x1	40	25x15		0,16	mc. 0,0002
134004-022	■ GRIGIO/GREY	x1	40	25x15		0,16	mc. 0,0002

+ 11 + 12 + 13 VITI / SCREWS

28 SCHIENALE IN MULTISTRATO FAGGIO							
BACK IN PLYWOOD BEECH							
CODICE/CODE	FINITURA/FINISHING	Q. KIT	Q. MIN/PACK	A	B	KG. x1/WT.x1	VOL. x1/UNIT VOL.
122107-010	■ FAGGIO/BEECH WOOD	x1	15	425	280	1,30	

30 SQUARE SDLF-SEDILO MULTISTRATO FAGGIO VERNICIATO + VITI							
SQUARE SDLF-PAINTED BEECH WOOD SEAT WITH SCREWS							
CODICE/CODE	FINITURA/FINISHING	Q. KIT	Q. MIN/PACK	A	B	KG. x1/WT.x1	VOL. x1/UNIT VOL.
122207-015	■ FAGGIO/BEECH WOOD	x1	15	422	280	1,65	

29 SCHIENALE TAPPEZZATO CUOIO							
BLACK UPHOLTERED IN BLACK LEATHER							
CODICE/CODE	FINITURA/FINISHING	Q. KIT	Q. MIN/PACK	A	B	KG. x1/WT.x1	VOL. x1/UNIT VOL.
142103-001	■ CUOIO/LEATHER	x1	15	430	450	1,05	

31 SQUARE SDCNR-SEDILO TAPPEZZATO CUOIO NERO + VITI							
SQUARE SDCNR-BLACK LEATHER SEAT WITH SCREWS							
CODICE/CODE	FINITURA/FINISHING	Q. KIT	Q. MIN/PACK	A	B	KG. x1/WT.x1	VOL. x1/UNIT VOL.
142203-001	■ CUOIO/LEATHER	x1	15	422	280	1,36	

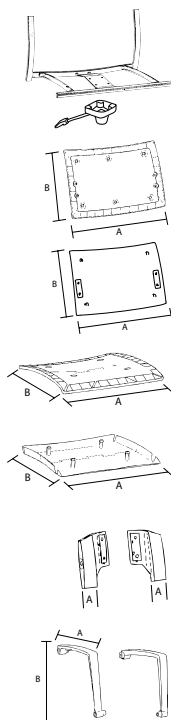
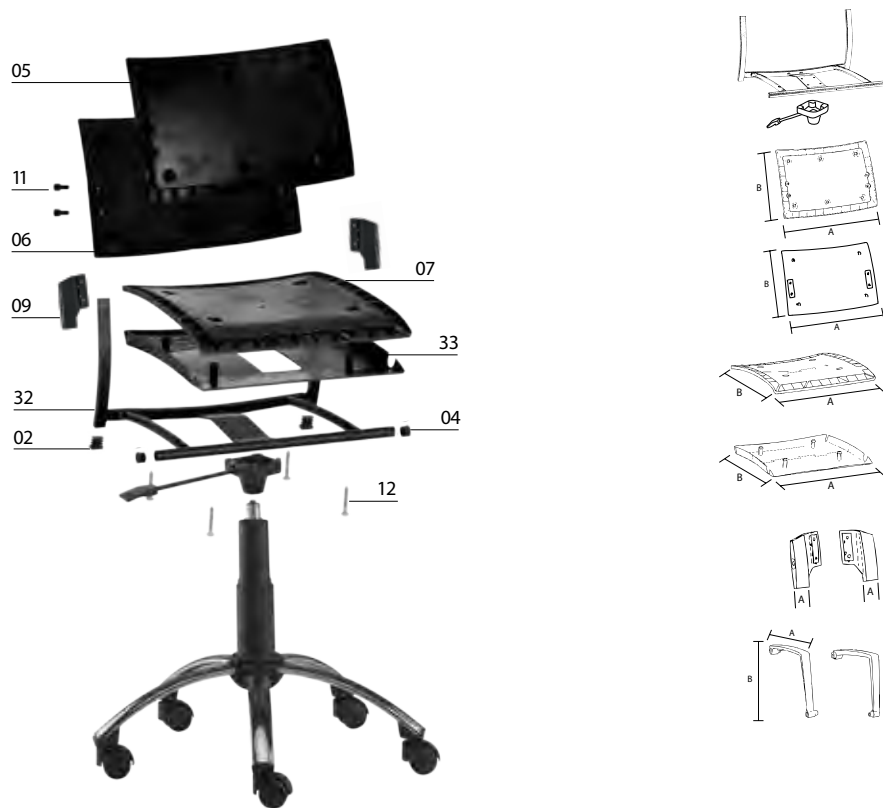

134
SQUARE

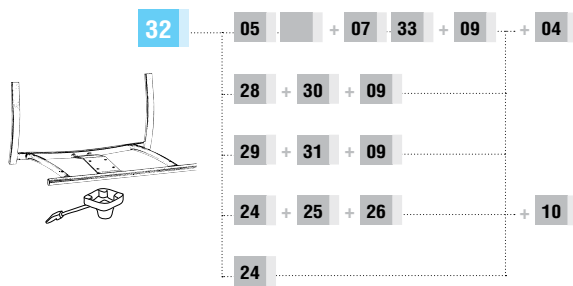

32 TELAIO GIREVOLE CON BLOCCETTO COMANDO A GAS
SWIVEL FRAME GAS WITH LEVER

CODICE/CODE	FINITURA/FINISHING	Q. KIT	Q. MIN/PACK	KG. x1/WT.x1	VOL. x1/UNIT VOL.
112603-029	■ NERO/BLACK	x1	100	3,50	mc. 0,05
112604-029	■ GRIGIO/GREY	x1	100	3,50	mc. 0,05

05 SQUARE-SHI-SCHIENALE INTERNO IN PLASTICA
SQUARE-SHI-INNER PLASTIC BACK

CODICE/CODE	FINITURA/FINISHING	Q. KIT	Q. MIN/PACK	A	B	KG. x1/WT.x1	VOL. x1/UNIT VOL.
132103-006	■ NERO/BLACK	x1	20	440	290	0,55	mc. 0,004

06 SQUARE-SHE-SCHIENALE ESTERNO IN PLASTICA
SQUARE-SHE-OUTER PLASTIC BACK

CODICE/CODE	FINITURA/FINISHING	Q. KIT	Q. MIN/PACK	A	B	KG. x1/WT.x1	VOL. x1/UNIT VOL.
132103-005	■ NERO/BLACK	x1	20	425	280	0,37	mc. 0,004
132104-026	■ GRIGIO/GREY	x1	20	425	280	0,37	mc. 0,004

07 SQUARE-SEDILE INTERNO IN PLASTICA
SQUARE-INNER PLASTIC SEAT

CODICE/CODE	FINITURA/FINISHING	Q. KIT	Q. MIN/PACK	A	B	KG. x1/WT.x1	VOL. x1/UNIT VOL.
132203-007	■ NERO/BLACK	x1	20	440	460	0,90	mc. 0,005

33 SQUARE-SEDILE ESTERNO IN PLASTICA
SQUARE-OUTER PLASTIC SEAT

CODICE/CODE	FINITURA/FINISHING	Q. KIT	Q. MIN/PACK	A	B	KG. x1/WT.x1	VOL. x1/UNIT VOL.
132203-006	■ NERO/BLACK	x1	20	430	450	0,53	mc. 0,008
132204-026	■ GRIGIO/GREY	x1	20	430	450	0,53	mc. 0,008

09 SQUARE-COPPIA SUPPORTI SCHIENALE IN PLASTICA
SQUARE-PLASTIC PAIR OF SUPPORTS FOR BACK

CODICE/CODE	FINITURA/FINISHING	Q. KIT	Q. MIN/PACK	A	KG. x1/WT.x1	VOL. x1/UNIT VOL.
134003-087	■ NERO/BLACK	x1	40	25x15	0,16	mc. 0,0002
134004-022	■ GRIGIO/GREY	x1	40	25x15	0,16	mc. 0,0002

10 SQUARE-COPPIA BRACCIOLI IN PLASTICA
SQUARE-PLASTIC PAIR ARMS

CODICE/CODE	FINITURA/FINISHING	Q. KIT	Q. MIN/PACK	A	B	KG. x1/WT.x1	VOL. x1/UNIT VOL.
131703-005	■ NERO/BLACK	x1	10	360	260	0,70	mc. 0,006
131704-005	■ GRIGIO/GREY	x1	10	360	260	0,70	mc. 0,006

11 VITE TESTA CILINDRICA A CROCE M6X16 ZINCATA
SCREW CYLINDRICAL CROSS HEAD M6X16 ZINC

CODICE/CODE	FINITURA/FINISHING	Q. KIT
117711-191	■ ZINCATA/ZINC	x4

12 VITE TESTA SVASATA A CROCE M6X30 ZINCATA (VITE PER FISSAGGIO SEDILE)
SCREW FLARED HEAD M6X30 ZINC (SCREW FOR SIX SEAT)

CODICE/CODE	FINITURA/FINISHING	Q. KIT
117711-192	■ ZINCATA/ZINC	x4

02 PUNTALE ALETTATO RETTANGOLARE 25X15
RIBBED RECTANGULAR INSERT 25X15

CODICE/CODE	FINITURA/FINISHING	Q. KIT
134203-020	■ NERO/BLACK	x2
134204-020	■ GRIGIO/GREY	x2

04 TAPPO COPRITESTA Ø22 PER SEDIA SENZA BRACCIOLI
COVER HEAD CAP Ø22 FOR CHAIR WITHOUT ARMS

CODICE/CODE	FINITURA/FINISHING	Q. KIT
134103-220	■ NERO/BLACK	x2
134104-220	■ GRIGIO/GREY	x2

SWIVEL OPTIONS:

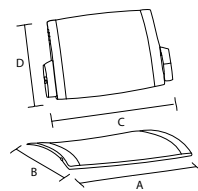

24		SQUARE-COPPIA SEDILE SCHIENALE IN PLASTICA COLORATO								
		SQUARE-PLASTIC SEAT/BACK COLOURED AT SIGHT								
CODICE/CODE	FINITURA/FINISHING	Q. KIT	Q. MIN/PACK	A	B	C	D	KG. x1/WT.x1	VOL. x1/UNIT VOL.	
134003-088	■ NERO/BLACK	x1	10	450	440	500	300	1,62	mc. 0,012	
134004-023	■ GRIGIO/GREY RAL7040	x1	10	450	440	500	300	1,62	mc. 0,012	
134002-023	■ ROSSO/RED PPL42	x1	10	450	440	500	300	1,62	mc. 0,012	
134015-023	■ BLU/BLUE RAL5002	x1	10	450	440	500	300	1,62	mc. 0,012	
134007-023	■ ARANCIO/ORANGE PPL22	x1	10	450	440	500	300	1,62	mc. 0,012	
134005-023	■ BEIGE/BEIGE PPL09	x1	10	450	440	500	300	1,62	mc. 0,012	

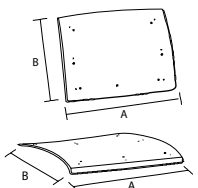

25		PANNELLO SCHIENALE DA TAPPEZZARE								
		PANEL BACK FOR UPHOLSTERY								
CODICE/CODE	FINITURA/FINISHING	Q. KIT	Q. MIN/PACK	A	B			KG. x1/WT.x1	VOL. x1/UNIT VOL.	
132103-046	■ NERO/BLACK	x1	20	390	310			0,50	mc. 0,004	

26		PANNELLO SEDILE DA TAPPEZZARE								
		PANEL SEAT FOR UPHOLSTERY								
CODICE/CODE	FINITURA/FINISHING	Q. KIT	Q. MIN/PACK	A	B			KG. x1/WT.x1	VOL. x1/UNIT VOL.	
132203-046	■ NERO/BLACK	x1	20	400	450			0,60	mc. 0,004	

27		VITE AUTOFILETT. 5X14 PER PANNELLO SCHIENALE E SEDILE DA TAPPEZZARE									
		SCREW AUTO-THREAD 5X14 FOR UPHOLSTERY BACK AND SEAT PANEL									
CODICE/CODE	FINITURA/FINISHING	Q. KIT								KG. x1/WT.x1	VOL. x1/UNIT VOL.
117803-156	■ NERO/BLACK	x4+4	schienale + sedile/back + seat								

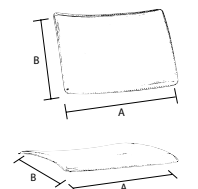

28		SCHIENALE IN MULTISTRATO FAGGIO								
		BACK IN PLYWOOD BEECH								
CODICE/CODE	FINITURA/FINISHING	Q. KIT	Q. MIN/PACK	A	B			KG. x1/WT.x1	VOL. x1/UNIT VOL.	
122107-010	■ FAGGIO/BEECH WOOD	x1	15	425	280			1,30		

30		SQUARE SDF-SEDILE MULTISTRATO FAGGIO VERNICIATO + VITI								
		SQUARE SDF-PAINTED BEECH WOOD SEAT WITH SCREWS								
CODICE/CODE	FINITURA/FINISHING	Q. KIT	Q. MIN/PACK	A	B			KG. x1/WT.x1	VOL. x1/UNIT VOL.	
122207-015	■ FAGGIO/BEECH WOOD	x1	15	422	280			1,65		

29		SCHIENALE TAPPEZZATO CUOIO								
		BLACK UPHOLTERED IN BLACK LEATHER								
CODICE/CODE	FINITURA/FINISHING	Q. KIT	Q. MIN/PACK	A	B			KG. x1/WT.x1	VOL. x1/UNIT VOL.	
142103-001	■ CUOIO/LEATHER	x1	15	430	450			1,05		

31		SQUARE SDCNR-SEDILE TAPPEZZATO CUOIO NERO + VITI								
		SQUARE SDCNR-BLACK LEATHER SEAT WITH SCREWS								
CODICE/CODE	FINITURA/FINISHING	Q. KIT	Q. MIN/PACK	A	B			KG. x1/WT.x1	VOL. x1/UNIT VOL.	
142203-001	■ CUOIO/LEATHER	x1	15	422	280			1,36		

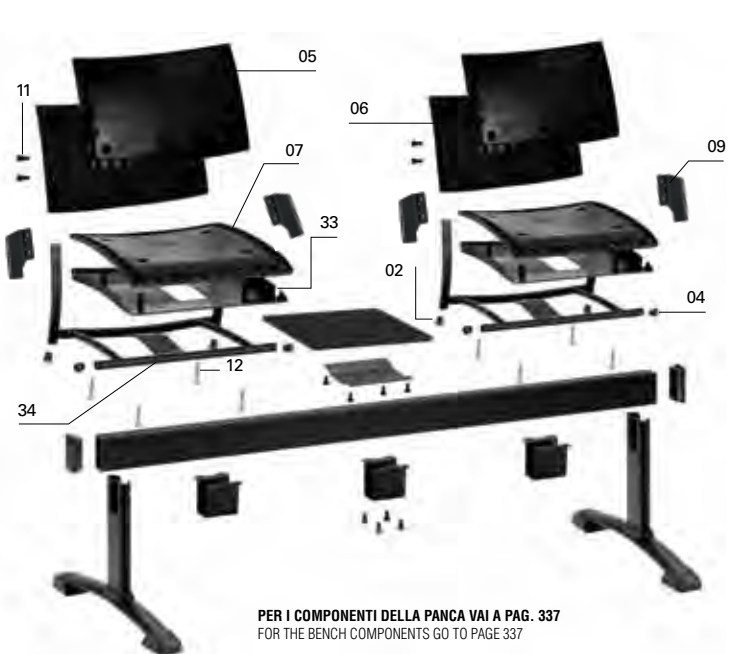

PER I COMPONENTI DELLA PANCA VAI A PAG. 337
FOR THE BENCH COMPONENTS GO TO PAGE 337

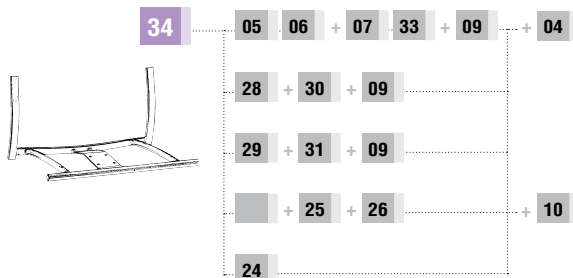
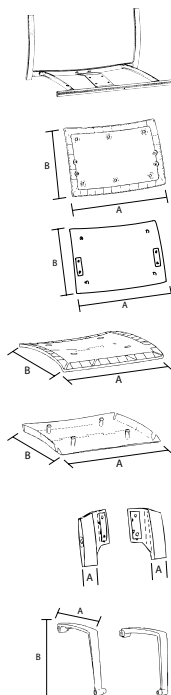

34	SQUARE-P TELAIO PER PANCA TAPPI ESCLUSI SQUARE-P BENCH FRAME CAPS EXCLUDED	CODICE/CODE 110703-050 110704-063	FINITURA/FINISHING ■ NERO/BLACK ■ GRIGIO/GREY	Q. KIT x1 x1	Q. MIN/PACK 100 100	KG. x1/WT.x1 2,80 2,80	VOL. x1/UNIT VOL. mc. 0,020 mc. 0,020	
05	SQUARE-SHI-SCHIENALE INTERNO IN PLASTICA SQUARE-SHI-INNER PLASTIC BACK	CODICE/CODE 132103-006	FINITURA/FINISHING ■ NERO/BLACK	Q. KIT x1	Q. MIN/PACK 20	A B 440 290	KG. x1/WT.x1 0,55	VOL. x1/UNIT VOL. mc. 0,004
06	SQUARE-SHE-SCHIENALE ESTERNO IN PLASTICA SQUARE-SHE-OUTER PLASTIC BACK	CODICE/CODE 132103-005 132104-026	FINITURA/FINISHING ■ NERO/BLACK ■ GRIGIO/GREY	Q. KIT x1 x1	Q. MIN/PACK 20 20	A B 425 280 425 280	KG. x1/WT.x1 0,37 0,37	VOL. x1/UNIT VOL. mc. 0,004 mc. 0,004
07	SQUARE-SEDILO INTERNO IN PLASTICA SQUARE-INNER PLASTIC SEAT	CODICE/CODE 132203-007	FINITURA/FINISHING ■ NERO/BLACK	Q. KIT x1	Q. MIN/PACK 20	A B 440 460	KG. x1/WT.x1 0,90	VOL. x1/UNIT VOL. mc. 0,005
33	SQUARE-SEDILO ESTERNO IN PLASTICA SQUARE-OUTER PLASTIC SEAT	CODICE/CODE 132203-006 132204-026	FINITURA/FINISHING ■ NERO/BLACK ■ GRIGIO/GREY	Q. KIT x1 x1	Q. MIN/PACK 20 20	A B 430 450 430 450	KG. x1/WT.x1 0,53 0,53	VOL. x1/UNIT VOL. mc. 0,008 mc. 0,008
09	SQUARE-COPPIA SUPPORTI SCHIENALE IN PLASTICA SQUARE-PLASTIC PAIR OF SUPPORTS FOR BACK	CODICE/CODE 134003-087 134004-022	FINITURA/FINISHING ■ NERO/BLACK ■ GRIGIO/GREY	Q. KIT x1 x1	Q. MIN/PACK 40 40	A 25x15 25x15	KG. x1/WT.x1 0,16 0,16	VOL. x1/UNIT VOL. mc. 0,0002 mc. 0,0002
10	SQUARE-COPPIA BRACCIOILI IN PLASTICA SQUARE-PLASTIC PAIR ARMS	CODICE/CODE 131703-005 131704-005	FINITURA/FINISHING ■ NERO/BLACK ■ GRIGIO/GREY	Q. KIT x1 x1	Q. MIN/PACK 10 10	A B 360 260 360 260	KG. x1/WT.x1 0,70 0,70	VOL. x1/UNIT VOL. mc. 0,006 mc. 0,006
11	VITE TESTA CILINDRICA A CROCE M6X16 ZINCATA SCREW CYLINDRICAL CROSS HEAD M6X16 ZINC	CODICE/CODE 117711-191	FINITURA/FINISHING □ ZINCATA/ZINC	Q. KIT x4				
12	VITE TESTA SVASATA A CROCE M6X30 ZINCATA (VITE PER FISSAGGIO SEDILE) SCREW FLARED HEAD M6X30 ZINC (SCREW FOR SIX SEAT)	CODICE/CODE 117711-192	FINITURA/FINISHING □ ZINCATA/ZINC	Q. KIT x4				
02	PUNTALE ALETTATO RETTANGOLARE 25X15 RIBBED RECTANGULAR INSERT 25X15	CODICE/CODE 134203-020 134204-020	FINITURA/FINISHING ■ NERO/BLACK ■ GRIGIO/GREY	Q. KIT x2 x2				
04	TAPPO COPRITESTA Ø22 PER SEDIA SENZA BRACCIOILI COVER HEAD CAP Ø22 FOR CHAIR WITHOUT ARMS	CODICE/CODE 134103-220 134104-220	FINITURA/FINISHING ■ NERO/BLACK ■ GRIGIO/GREY	Q. KIT x2 x2				

OPTIONAL GAMBA
LEG OPTIONAL



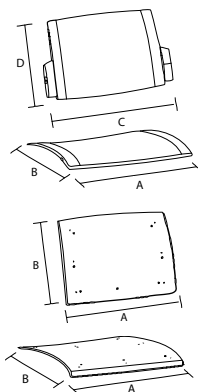

24 SQUARE-COPPIA SEDILE SCHIENALE IN PLASTICA COLORATO SQUARE-PLASTIC SEAT/BACK COLOURED AT SIGHT									
CODICE/CODE	FINITURA/FINISHING	Q. KIT	Q. MIN/PACK	A	B	C	D	KG. x1/WT.x1	VOL. x1/UNIT VOL.
134003-088	■ NERO/BLACK	x1	10	450	440	500	300	1,62	mc. 0,012
134004-023	■ GRIGIO/GREY RAL7040	x1	10	450	440	500	300	1,62	mc. 0,012
134002-023	■ ROSSO/RED	x1	10	450	440	500	300	1,62	mc. 0,012
134015-023	■ BLU/BLUE RAL5002	x1	10	450	440	500	300	1,62	mc. 0,012
134007-023	■ ARANCIO/ORANGE PPL22	x1	10	450	440	500	300	1,62	mc. 0,012
134005-023	■ BEIGE/BEIGE PPL09	x1	10	450	440	500	300	1,62	mc. 0,012

25 PANNELLO SCHIENALE DA TAPPEZZARE PANEL BACK FOR UPHOLSTERY									
CODICE/CODE	FINITURA/FINISHING	Q. KIT	Q. MIN/PACK	A	B	KG. x1/WT.x1	VOL. x1/UNIT VOL.		
132103-046	■ NERO/BLACK	x1	20	390	310	0,50	mc. 0,004		

26 PANNELLO SEDILE DA TAPPEZZARE PANEL SEAT FOR UPHOLSTERY									
CODICE/CODE	FINITURA/FINISHING	Q. KIT	Q. MIN/PACK	A	B	KG. x1/WT.x1	VOL. x1/UNIT VOL.		
132203-046	■ NERO/BLACK	x1	20	400	450	0,60	mc. 0,004		

27 VITE AUTOFILETT. 5X14 PER PANNELLO SCHIENALE E SEDILE DA TAPPEZZARE SCREW AUTO-THREAD 5X14 FOR UPHOLSTERY BACK AND SEAT PANEL									
CODICE/CODE	FINITURA/FINISHING	Q. KIT							
117803-156	■ NERO/BLACK	x4+4	schienale + sedile/back + seat						

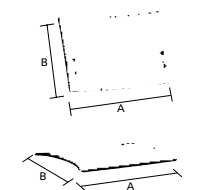

28 SCHIENALE IN MULTISTRATO FAGGIO BACK IN PLYWOOD BEECH									
CODICE/CODE	FINITURA/FINISHING	Q. KIT	Q. MIN/PACK	A	B	KG. x1/WT.x1			
122107-010	■ FAGGIO/BEECH WOOD	x1	15	425	280	1,30			

30 SQUARE SDF-SEDILE MULTISTRATO FAGGIO VERNICIATO + VITI SQUARE SDF-PAINTED BEECH WOOD SEAT WITH SCREWS									
CODICE/CODE	FINITURA/FINISHING	Q. KIT	Q. MIN/PACK	A	B	KG. x1/WT.x1			
122207-015	■ FAGGIO/BEECH WOOD	x1	15	422	280	1,65			

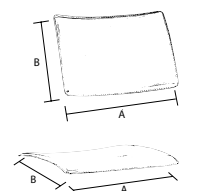

29 SCHIENALE TAPPEZZATO CUOIO BLACK UPHOLTERED IN BLACK LEATHER									
CODICE/CODE	FINITURA/FINISHING	Q. KIT	Q. MIN/PACK	A	B	KG. x1/WT.x1			
142103-001	■ CUOIO/LEATHER	x1	15	430	450	1,05			

31 SQUARE SDCNR-SEDILE TAPPEZZATO CUOIO NERO + VITI SQUARE SDCNR-BLACK LEATHER SEAT WITH SCREWS									
CODICE/CODE	FINITURA/FINISHING	Q. KIT	Q. MIN/PACK	A	B	KG. x1/WT.x1			
142203-001	■ CUOIO/LEATHER	x1	15	422	280	1,36			





ALBA  



PINKO

SLIDE

4 LEGS

4 LEGS FOR CASTORS

SWIVEL

BENCH



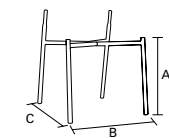
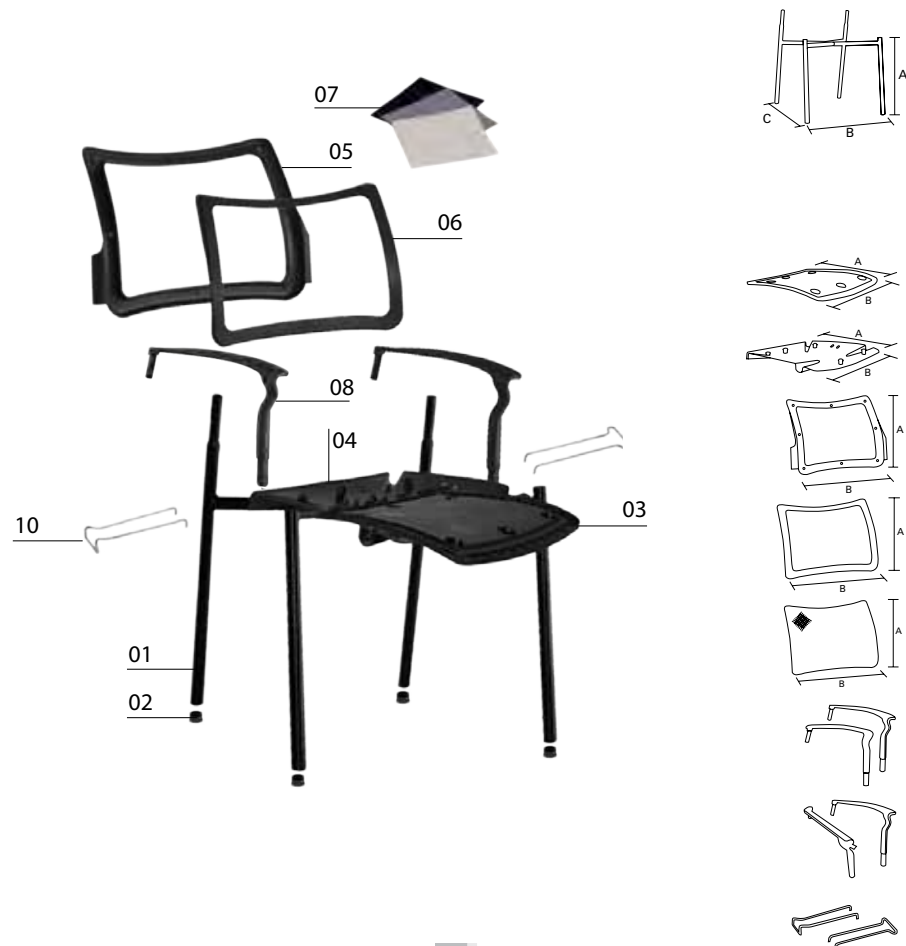

01 PINKO-TELAIO QUATTRO GAMBE FISSO PER BRACCIOLI SENZA TAPPI PINKO-FIXED FOUR LEGS FRAME FOR ARMS WITHOUT CAPS		Q. KIT	Q. MIN/PACK	A	B	C	KG. x1/WT.x1	VOL. x1/UNIT VOL.
112603-040	■ NERO/BLACK	x1	80	450	530	530	3,20	mc. 0,035
112604-040	■ GRIGIO/GREY	x1	80	450	530	530	3,20	mc. 0,035
112610-040	■ CROMATO/CHROME	x1	80	450	530	530	3,20	mc. 0,035
02 PUNTALE ALETTATO TESTA SFERICA D.25 SPHERICAL CAP D.25		Q. KIT						
134203-250	■ NERO/BLACK	x4						
03 PINKO-SEDILE INTERNO DA TAPPEZZARE PINKO-INNER SEAT FOR UPHOLSTERY		Q. KIT	Q. MIN/PACK	A	B			
132203-025	■ NERO/BLACK	x1	20	465	470	0,73	mc. 0,006	
04 PINKO-SEDILE ESTERNO PLASTICA PINKO-OUTER PLASTIC SEAT		Q. KIT	Q. MIN/PACK	A	B			
132203-026	■ NERO/BLACK	x1	20	465	470	0,62	mc. 0,007	
05 PINKO-TELAIO SCHIENALE IN PLASTICA PER RETE (PORTANTE) PINKO-BACK FRAME IN PLASTIC FOR MESH		Q. KIT	Q. MIN/PACK	A	B			
132103-027	■ NERO/BLACK	x1	20	345	495	0,50	mc. 0,0045	
06 PINKO-CORNICE SCHIENALE IN PLASTICA PER RETE PINKO-OPEN FRAME IN PLASTIC FOR MESH		Q. KIT	Q. MIN/PACK	A	B			
132103-028	■ NERO/BLACK	x1	20	345	495	0,35	mc. 0,0057	
07 PINKO-RETE PER SCHIENALE PINKO-NET FOR PINKO BACK		Q. KIT	Q. MIN/PACK	A	B			
132105-501	□ BIANCO/WHITE	x1	25	460	520	0,14	mc. 0,0057	
132103-501	■ NERO/BLACK	x1	25	460	520	0,14	mc. 0,0057	
132104-501	■ GRIGIO/GREY	x1	25	460	520	0,14	mc. 0,0057	
08 PINKO-COPPIA BRACCIOLI DX/SX IN PLASTICA PINKO-PAIR OF PLASTIC ARMS RIGHT/LEFT		Q. KIT	Q. MIN/PACK					
131703-050	■ NERO/BLACK	x1	10	0,66 mc. 0,0037				
09 PINKO-COPPIA BRACCIOLI + GANCIO PORTATAVOLETTA DESTRO IN PLASTICA PINKO-PAIR OF PLASTIC ARMS RIGHT/LEFT WITH JOINT FOR WRITING TABLET		Q. KIT	Q. MIN/PACK					
131703-051	■ NERO/BLACK	x1	10	0,70 mc. 0,0037				
10 PINKO-COPPIA AGGANCI LATERALE MASCHIO + FEMMINA CROMATI PINKO-CHROME LATERAL HOOKS MALE + FEMAL WITH SCREWS		Q. KIT	Q. MIN/PACK	KG. x1/WT.x1	VOL. x1/UNIT VOL.			
113410-100	■ CROMATO/CHROME	x1	100	0,13	mc. 0,0004			

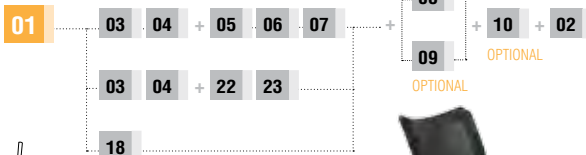

OPTIONAL 09
BRACCIOLO + GANCIO PORTATAVOLETTA
ARMS WITH JOINT FOR WRITING TABLET



OPTIONAL

TAVOLETTA TLT
TLT TABLET



VEDI/SEE PAG. 327

TAVOLETTA TLT2
TLT2 TABLET



VEDI/SEE PAG. 327

TAVOLETTA TLT3
TLT3 TABLET



VEDI/SEE PAG. 327

TAVOLETTA BEAN
BEAN TABLET



VEDI/SEE PAG. 327

TAVOLETTA TL01
TL01 TABLET



VEDI/SEE PAG. 327

SNODO TAVOLETTA SPT2
SPT2 MECHANISM TABLET



VEDI/SEE PAG. 326

SNODO ANTIPANICO
MECHANISM ANTIPANIC



VEDI/SEE PAG. 326

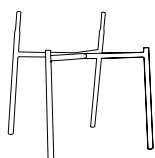

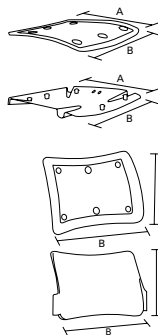

03 PINKO-SEDILE INTERNO DA TAPPEZZARE								
PINKO-INNER SEAT FOR UPHOLSTERY								
CODICE/CODE	FINITURA/FINISHING	Q. KIT	Q. MIN/PACK	A	B	KG. x1/WT.x1	VOL. x1/UNIT VOL.	
132203-025	■ NERO/BLACK	x1	20	465	470	0,73	mc. 0,006	
04 PINKO-SEDILE ESTERNO PLASTICA								
PINKO-OUTER PLASTIC SEAT								
CODICE/CODE	FINITURA/FINISHING	Q. KIT	Q. MIN/PACK	A	B	KG. x1/WT.x1	VOL. x1/UNIT VOL.	
132203-026	■ NERO/BLACK	x1	20	465	470	0,62	mc. 0,007	
22 PINKO-SCHIENALE INTERNO DA TAPPEZZARE								
PINKO-INNER BACK FOR UPHOLSTERY								
CODICE/CODE	FINITURA/FINISHING	Q. KIT	Q. MIN/PACK	A	B	KG. x1/WT.x1	VOL. x1/UNIT VOL.	
132103-025	■ NERO/BLACK	x1	20	350	495	0,62	mc. 0,009	
23 PINKO-SCHIENALE ESTERNO PLASTICA								
PINKO-OUTER PLASTIC BACK								
CODICE/CODE	FINITURA/FINISHING	Q. KIT	Q. MIN/PACK	A	B	KG. x1/WT.x1	VOL. x1/UNIT VOL.	
132103-026	■ NERO/BLACK	x1	20	350	495	0,25	mc. 0,0045	

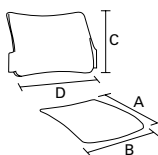

18 PINKO-SEDILE/SCHIENALE IN PLASTICA COLORATO A VISTA									
PINKO-PLASTIC SEAT/BACK COLOURED AT SIGHT									
CODICE/CODE	FINITURA/FINISHING	Q. KIT	Q. MIN/PACK	A	B	C	D	KG. x1/WT.x1	VOL. x1/UNIT VOL.
134015-108	■ BLU/BLUE 5002	x1	20	470	465	350	495	1,78	mc. 0,014
134003-108	■ NERO/BLACK	x1	20	470	465	350	495	1,78	mc. 0,014
134004-109	■ GRIGIO/GREY 7035	x1	20	470	465	350	495	1,78	mc. 0,014



PINKO-CARRELLO PORTASEDIE CON ACCESSORI NERO									
PINKO-TROLLEY FOR CHAIRS WITH ACCESSORIES BLACK									
CODICE/CODE	FINITURA/FINISHING	Q. KIT	Q. MIN/PACK	A	B	C	D	KG. x1/WT.x1	VOL. x1/UNIT VOL.
112603-047	■ NERO/BLACK								

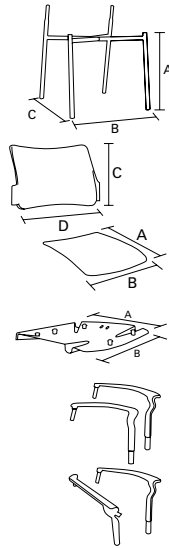

11	PINKO-TELAIO QUATTRO GAMBE PER RUOTE + 4 RIDUTTORI PER RUOTE PINKO FOUR LEGS FRAME FOR CASTORS + 4 ADAPTERS FOR CASTORS								
CODICE/CODE	FINITURA/FINISHING	Q. KIT	Q. MIN/PACK	A	B	C	KG. x1/WT.x1	VOL. x1/UNIT VOL.	
112603-041	■ NERO/BLACK	x1	80	450	530	530	3,20	mc. 0,035	
112604-041	■ GRIGIO/GREY	x1	80	450	530	530	3,20	mc. 0,035	
112610-041	■ CROMATO/CHROME	x1	80	450	530	530	3,20	mc. 0,035	
18	PINKO-SEDILE/SCHIENALE IN PLASTICA COLORATO A VISTA PINKO-PLASTIC SEAT/BACK COLOURED AT SIGHT								
CODICE/CODE	FINITURA/FINISHING	Q. KIT	Q. MIN/PACK	A	B	C	D	KG. x1/WT.x1	VOL. x1/UNIT VOL.
134015-108	■ BLU/BLUE 5002	x1	20	470	465	350	495	1,78	mc. 0,014
134003-108	■ NERO/BLACK	x1	20	470	465	350	495	1,78	mc. 0,014
134004-109	■ GRIGIO/GREY 7035	x1	20	470	465	350	495	1,78	mc. 0,014
04	PINKO-SEDILE ESTERNO PLASTICA PINKO-OUTER PLASTIC SEAT								
CODICE/CODE	FINITURA/FINISHING	Q. KIT	Q. MIN/PACK	A	B		KG. x1/WT.x1	VOL. x1/UNIT VOL.	
132203-026	■ NERO/BLACK	x1	20	465	470		0,62	mc. 0,007	
08	PINKO-COPPIA BRACCIOLI DX/SX IN PLASTICA PINKO-PAIR OF PLASTIC ARMS RIGHT/LEFT								
CODICE/CODE	FINITURA/FINISHING	Q. KIT	Q. MIN/PACK				KG. x1/WT.x1	VOL. x1/UNIT VOL.	
131703-050	■ NERO/BLACK	x1	10				0,66	mc. 0,0037	
09	PINKO-COPPIA BRACCIOLI + GANCIO PORTATAVOLETTA DESTRO IN PLASTICA PINKO-PAIR OF PLASTIC ARMS RIGHT/LEFT WITH JOINT FOR WRITING TABLET								
CODICE/CODE	FINITURA/FINISHING	Q. KIT	Q. MIN/PACK				KG. x1/WT.x1	VOL. x1/UNIT VOL.	
131703-051	■ NERO/BLACK	x1	10				0,70	mc. 0,0037	
12	DOPPIA RUOTA D.50 IN DESMOPAN CON PERNO MONTATO TWIN WHEEL CASTOR D.50 DESMOPAN WITH PIVOT MOUNTED								
CODICE/CODE	FINITURA/FINISHING	Q. KIT							
134403-003	■ NERO/BLACK	x4							

OPTIONAL 09
BRACCIOLO + GANCIO PORTATAVOLETTA
ARMS WITH JOINT FOR WRITING TABLET

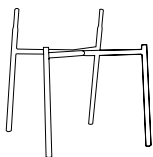
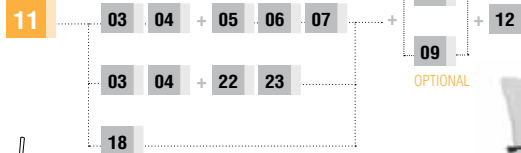

OPTIONAL

TAVOLETTA TLT TLT TABLET	TAVOLETTA TLT2 TLT2 TABLET	TAVOLETTA TLT3 TLT3 TABLET	TAVOLETTA BEAN BEAN TABLET	TAVOLETTA TL01 TL01 TABLET	SNODO TAVOLETTA SPT2 SPT2 MECHANISM TABLET	SNODO ANTIPANICO MECHANISM ANTIPANIC
						
VEDI/SEE PAG. 327	VEDI/SEE PAG. 327	VEDI/SEE PAG. 327	VEDI/SEE PAG. 327	VEDI/SEE PAG. 327	VEDI/SEE PAG. 326	VEDI/SEE PAG. 326

4 LEGS FOR CASTORS OPTIONS:

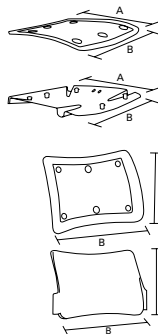

03	PINKO-SEDILE INTERNO DA TAPPEZZARE PINKO-INNER SEAT FOR UPHOLSTERY								
CODICE/CODE	FINITURA/FINISHING	Q. KIT	Q. MIN/PACK	A	B	KG. x1/WT.x1	VOL. x1/UNIT VOL.		
132203-025	■ NERO/BLACK	x1	20	465	470	0,73	mc. 0,006		
04	PINKO-SEDILE ESTERNO PLASTICA PINKO-OUTER PLASTIC SEAT								
CODICE/CODE	FINITURA/FINISHING	Q. KIT	Q. MIN/PACK	A	B	KG. x1/WT.x1	VOL. x1/UNIT VOL.		
132203-026	■ NERO/BLACK	x1	20	465	470	0,62	mc. 0,007		
22	PINKO-SCHIENALE INTERNO DA TAPPEZZARE PINKO-INNER BACK FOR UPHOLSTERY								
CODICE/CODE	FINITURA/FINISHING	Q. KIT	Q. MIN/PACK	A	B	KG. x1/WT.x1	VOL. x1/UNIT VOL.		
132103-025	■ NERO/BLACK	x1	20	350	495	0,62	mc. 0,009		
23	PINKO-SCHIENALE ESTERNO PLASTICA PINKO-OUTER PLASTIC BACK								
CODICE/CODE	FINITURA/FINISHING	Q. KIT	Q. MIN/PACK	A	B	KG. x1/WT.x1	VOL. x1/UNIT VOL.		
132103-026	■ NERO/BLACK	x1	20	350	495	0,25	mc. 0,0045		

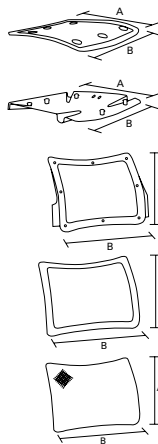

03	PINKO-SEDILE INTERNO DA TAPPEZZARE PINKO-INNER SEAT FOR UPHOLSTERY								
CODICE/CODE	FINITURA/FINISHING	Q. KIT	Q. MIN/PACK	A	B	KG. x1/WT.x1	VOL. x1/UNIT VOL.		
132203-025	■ NERO/BLACK	x1	20	465	470	0,73	mc. 0,006		
04	PINKO-SEDILE ESTERNO PLASTICA PINKO-OUTER PLASTIC SEAT								
CODICE/CODE	FINITURA/FINISHING	Q. KIT	Q. MIN/PACK	A	B	KG. x1/WT.x1	VOL. x1/UNIT VOL.		
132203-026	■ NERO/BLACK	x1	20	465	470	0,62	mc. 0,007		
05	PINKO-TELAIO SCHIENALE IN PLASTICA PER RETE (PORTANTE) PINKO-BACK FRAME IN PLASTIC FOR MESH								
CODICE/CODE	FINITURA/FINISHING	Q. KIT	Q. MIN/PACK	A	B	KG. x1/WT.x1	VOL. x1/UNIT VOL.		
132103-027	■ NERO/BLACK	x1	20	345	495	0,50	mc. 0,0045		
06	PINKO-CORNICE SCHIENALE IN PLASTICA PER RETE PINKO-OPEN FRAME IN PLASTIC FOR MESH								
CODICE/CODE	FINITURA/FINISHING	Q. KIT	Q. MIN/PACK	A	B	KG. x1/WT.x1	VOL. x1/UNIT VOL.		
132103-028	■ NERO/BLACK	x1	20	345	495	0,35	mc. 0,0057		
07	PINKO-RETE PER SCHIENALE PINKO-NET FOR PINKO BACK								
CODICE/CODE	FINITURA/FINISHING	Q. KIT	Q. MIN/PACK	A	B	KG. x1/WT.x1	VOL. x1/UNIT VOL.		
132105-501	□ BIANCO/WHITE	x1	25	460	520	0,14	mc. 0,0057		
132103-501	■ NERO/BLACK	x1	25	460	520	0,14	mc. 0,0057		
132104-501	■ GRIGIO/GREY	x1	25	460	520	0,14	mc. 0,0057		

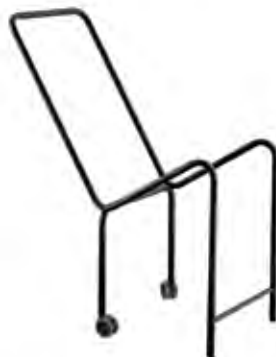

	PINKO-CARRELLO PORTASEDIE CON ACCESSORI NERO PINKO-TROLLEY FOR CHAIRS WITH ACCESSORIES BLACK								
CODICE/CODE	FINITURA/FINISHING								
112603-047	■ NERO/BLACK								

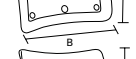
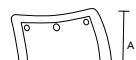
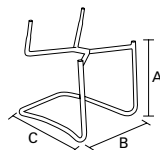

13 PINKO-BASE A SLITTA IN TUBO ASFORM D.25 TAPPI ESCLUSI
PINKO-SLIDE FRAME PIPE D.25 WITHOUT CAPS

CODICE/CODE	FINITURA/FINISHING	Q. KIT	Q. MIN/PACK	A	B	C	KG. x1/WT.x1	VOL. x1/UNIT VOL.
110503-093	■ NERO/BLACK	x1	40	450	550	550	4,60	mc. 0,06
110504-093	■ GRIGIO/GREY	x1	40	450	550	550	4,60	mc. 0,06
110510-093	■ CROMATO/CHROME	x1	40	450	550	550	4,60	mc. 0,06

14 PARACOLPI TESTA BOMBATA D.18
ROUND HEAD CAP D.18

CODICE/CODE	FINITURA/FINISHING	Q. KIT
134403-101	■ NERO/BLACK	x4

03 PINKO-SEDILE INTERNO DA TAPPEZZARE
PINKO-INNER SEAT FOR UPHOLSTERY

CODICE/CODE	FINITURA/FINISHING	Q. KIT	Q. MIN/PACK	A	B	KG. x1/WT.x1	VOL. x1/UNIT VOL.
132203-025	■ NERO/BLACK	x1	20	465	470	0,73	mc. 0,006

04 PINKO-SEDILE ESTERNO PLASTICA
PINKO-OUTER PLASTIC SEAT

CODICE/CODE	FINITURA/FINISHING	Q. KIT	Q. MIN/PACK	A	B	KG. x1/WT.x1	VOL. x1/UNIT VOL.
132203-026	■ NERO/BLACK	x1	20	465	470	0,62	mc. 0,007

22 PINKO-SCHIENALE INTERNO DA TAPPEZZARE
PINKO-INNER BACK FOR UPHOLSTERY

CODICE/CODE	FINITURA/FINISHING	Q. KIT	Q. MIN/PACK	A	B	KG. x1/WT.x1	VOL. x1/UNIT VOL.
132103-025	■ NERO/BLACK	x1	20	350	495	0,62	mc. 0,009

23 PINKO-SCHIENALE ESTERNO PLASTICA
PINKO-OUTER PLASTIC BACK

CODICE/CODE	FINITURA/FINISHING	Q. KIT	Q. MIN/PACK	A	B	KG. x1/WT.x1	VOL. x1/UNIT VOL.
132103-026	■ NERO/BLACK	x1	20	350	495	0,25	mc. 0,0045

08 PINKO-COPPIA BRACCIOLI DX/SX IN PLASTICA
PINKO-PAIR OF PLASTIC ARMS RIGHT/LEFT

CODICE/CODE	FINITURA/FINISHING	Q. KIT	Q. MIN/PACK	KG. x1/WT.x1	VOL. x1/UNIT VOL.
131703-050	■ NERO/BLACK	x1	10	0,66	mc. 0,0037

13 + 03 04 + 05 06 07 + 08 + 14

03 04 + 22 23

18

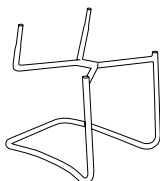

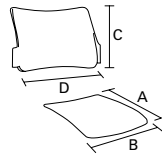

18 PINKO-SEDILE/SCHIENALE IN PLASTICA COLORATO A VISTA PINKO-PLASTIC SEAT/BACK COLOURED AT SIGHT										
CODICE/CODE	FINITURA/FINISHING	Q. KIT	Q. MIN/PACK	A	B	C	D	KG. x1/WT.x1	VOL. x1/UNIT VOL.	
134015-108	■ BLU/BLUE 5002	x1	20	470	465	350	495	1,78	mc. 0,014	
134003-108	■ NERO/BLACK	x1	20	470	465	350	495	1,78	mc. 0,014	
134004-109	■ GRIGIO/GREY 7035	x1	20	470	465	350	495	1,78	mc. 0,014	

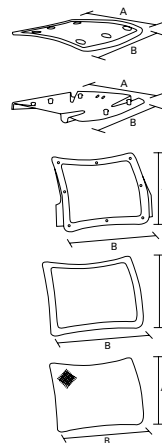

03 PINKO-SEDILE INTERNO DA TAPPEZZARE PINKO-INNER SEAT FOR UPHOLSTERY										
CODICE/CODE	FINITURA/FINISHING	Q. KIT	Q. MIN/PACK	A	B	KG. x1/WT.x1	VOL. x1/UNIT VOL.			
132203-025	■ NERO/BLACK	x1	20	465	470	0,73	mc. 0,006			

04 PINKO-SEDILE ESTERNO PLASTICA PINKO-OUTER PLASTIC SEAT										
CODICE/CODE	FINITURA/FINISHING	Q. KIT	Q. MIN/PACK	A	B	KG. x1/WT.x1	VOL. x1/UNIT VOL.			
132203-026	■ NERO/BLACK	x1	20	465	470	0,62	mc. 0,007			

05 PINKO-TELAIO SCHIENALE IN PLASTICA PER RETE (PORTANTE) PINKO-BACK FRAME IN PLASTIC FOR MESH										
CODICE/CODE	FINITURA/FINISHING	Q. KIT	Q. MIN/PACK	A	B	KG. x1/WT.x1	VOL. x1/UNIT VOL.			
132103-027	■ NERO/BLACK	x1	20	345	495	0,50	mc. 0,0045			

06 PINKO-CORNICE SCHIENALE IN PLASTICA PER RETE PINKO-OPEN FRAME IN PLASTIC FOR MESH										
CODICE/CODE	FINITURA/FINISHING	Q. KIT	Q. MIN/PACK	A	B	KG. x1/WT.x1	VOL. x1/UNIT VOL.			
132103-028	■ NERO/BLACK	x1	20	345	495	0,35	mc. 0,0057			

07 PINKO-RETE PER SCHIENALE PINKO-NET FOR PINKO BACK										
CODICE/CODE	FINITURA/FINISHING	Q. KIT	Q. MIN/PACK	A	B	KG. x1/WT.x1	VOL. x1/UNIT VOL.			
132105-501	□ BIANCO/WHITE	x1	25	460	520	0,14	mc. 0,0057			
132103-501	■ NERO/BLACK	x1	25	460	520	0,14	mc. 0,0057			
132104-501	■ GRIGIO/GREY	x1	25	460	520	0,14	mc. 0,0057			

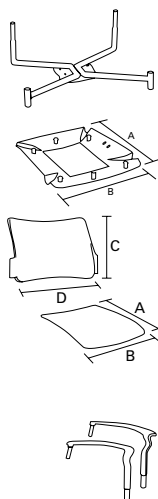

15	PINKO-TELAIO PER GIREVOLE COMANDO A GAS SENZA TAPPI PINKO-SWIVEL FRAME WITH GAS LEVER WITHOUT CAPS								
CODICE/CODE	FINITURA/FINISHING	Q. KIT	Q. MIN/PACK	KG. x1/WT.x1	VOL. x1/UNIT VOL.				
112603-045	■ NERO/BLACK	x1	80	2,60	mc. 0,005				
112604-045	■ GRIGIO/GREY	x1	80	2,60	mc. 0,005				
17	PINKO-SEDILE ESTERNO PLASTICA PER GIREVOLE E PANCA PINKO-PLASTIC OUTER SEAT FOR SWIVEL AND BENCH								
CODICE/CODE	FINITURA/FINISHING	Q. KIT	Q. MIN/PACK	A	B	KG. x1/WT.x1	VOL. x1/UNIT VOL.		
132203-027	■ NERO/BLACK	x1	20	465	470	0,60	mc. 0,007		
18	PINKO-SEDILE/SCHIENALE IN PLASTICA COLORATO A VISTA PINKO-PLASTIC SEAT/BACK COLOURED AT SIGHT								
CODICE/CODE	FINITURA/FINISHING	Q. KIT	Q. MIN/PACK	A	B	C	D	KG. x1/WT.x1	VOL. x1/UNIT VOL.
134015-108	■ BLU/BLUE 5002	x1	20	470	465	350	495	1,78	mc. 0,014
134003-108	■ NERO/BLACK	x1	20	470	465	350	495	1,78	mc. 0,014
134004-109	■ GRIGIO/GREY 7035	x1	20	470	465	350	495	1,78	mc. 0,014
16	TAPPO COPRITESTA ALETTATO D.25 NERO COVER HEAD D.25 BLACK								
CODICE/CODE	FINITURA/FINISHING	Q. KIT							
134103-250	■ NERO/BLACK	x2							
08	PINKO-COPPIA BRACCIOLI DX/SX IN PLASTICA PINKO-PAIR OF PLASTIC ARMS RIGHT/LEFT								
CODICE/CODE	FINITURA/FINISHING	Q. KIT	Q. MIN/PACK	KG. x1/WT.x1	VOL. x1/UNIT VOL.				
131703-050	■ NERO/BLACK	x1	10	0,66	mc. 0,0037				

146
PINKO

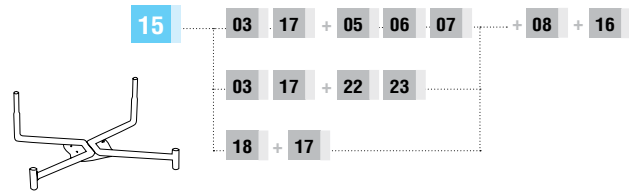

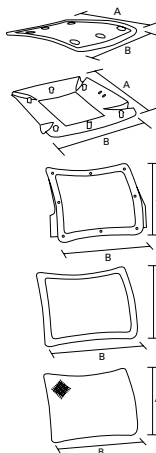
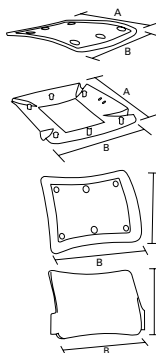

03 PINKO-SEDILE INTERNO DA TAPPEZZARE							
PINKO-INNER SEAT FOR UPHOLSTERY							
CODICE/CODE	FINITURA/FINISHING	Q. KIT	Q. MIN/PACK	A	B	KG. x1/WT.x1	VOL. x1/UNIT VOL.
132203-025	■ NERO/BLACK	x1	20	465	470	0,73	mc. 0,006
17 PINKO-SEDILE ESTERNO PLASTICA PER GIREVOLE E PANCA							
PINKO-PLASTIC OUTER SEAT FOR SWIVEL AND BENCH							
CODICE/CODE	FINITURA/FINISHING	Q. KIT	Q. MIN/PACK	A	B	KG. x1/WT.x1	VOL. x1/UNIT VOL.
132203-027	■ NERO/BLACK	x1	20	465	470	0,60	mc. 0,007
22 PINKO-SCHIENALE INTERNO DA TAPPEZZARE							
PINKO-INNER BACK FOR UPHOLSTERY							
CODICE/CODE	FINITURA/FINISHING	Q. KIT	Q. MIN/PACK	A	B	KG. x1/WT.x1	VOL. x1/UNIT VOL.
132103-025	■ NERO/BLACK	x1	20	350	495	0,62	mc. 0,009
23 PINKO-SCHIENALE ESTERNO PLASTICA							
PINKO-OUTER PLASTIC BACK							
CODICE/CODE	FINITURA/FINISHING	Q. KIT	Q. MIN/PACK	A	B	KG. x1/WT.x1	VOL. x1/UNIT VOL.
132103-026	■ NERO/BLACK	x1	20	350	495	0,25	mc. 0,0045

03 PINKO-SEDILE INTERNO DA TAPPEZZARE							
PINKO-INNER SEAT FOR UPHOLSTERY							
CODICE/CODE	FINITURA/FINISHING	Q. KIT	Q. MIN/PACK	A	B	KG. x1/WT.x1	VOL. x1/UNIT VOL.
132203-025	■ NERO/BLACK	x1	20	465	470	0,73	mc. 0,006
17 PINKO-SEDILE ESTERNO PLASTICA PER GIREVOLE E PANCA							
PINKO-PLASTIC OUTER SEAT FOR SWIVEL AND BENCH							
CODICE/CODE	FINITURA/FINISHING	Q. KIT	Q. MIN/PACK	A	B	KG. x1/WT.x1	VOL. x1/UNIT VOL.
132203-027	■ NERO/BLACK	x1	20	465	470	0,60	mc. 0,007
05 PINKO-TELAIO SCHIENALE IN PLASTICA PER RETE (PORTANTE)							
PINKO-BACK FRAME IN PLASTIC FOR MESH							
CODICE/CODE	FINITURA/FINISHING	Q. KIT	Q. MIN/PACK	A	B	KG. x1/WT.x1	VOL. x1/UNIT VOL.
132103-027	■ NERO/BLACK	x1	20	345	495	0,50	mc. 0,0045
06 PINKO-CORNICE SCHIENALE IN PLASTICA PER RETE							
PINKO-OPEN FRAME IN PLASTIC FOR MESH							
CODICE/CODE	FINITURA/FINISHING	Q. KIT	Q. MIN/PACK	A	B	KG. x1/WT.x1	VOL. x1/UNIT VOL.
132103-028	■ NERO/BLACK	x1	20	345	495	0,35	mc. 0,0057
07 PINKO-RETE PER SCHIENALE							
PINKO-NET FOR PINKO BACK							
CODICE/CODE	FINITURA/FINISHING	Q. KIT	Q. MIN/PACK	A	B	KG. x1/WT.x1	VOL. x1/UNIT VOL.
132105-501	□ BIANCO/WHITE	x1	25	460	520	0,14	mc. 0,0057
132103-501	■ NERO/BLACK	x1	25	460	520	0,14	mc. 0,0057
132104-501	■ GRIGIO/GREY	x1	25	460	520	0,14	mc. 0,0057

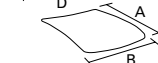
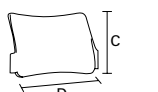
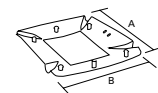
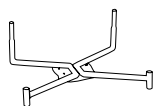

19	PINKO-TELAIO PER PANCA SENZA TAPPI PINKO-BENCH FRAME CAPS EXCLUDED	CODICE/CODE	FINITURA/FINISHING	Q. KIT	Q. MIN/PACK	KG. x1/WT.x1	VOL. x1/UNIT VOL.				
		110703-072	■ NERO/BLACK	x1	80	2,50	mc. 0,005				
		110704-072	■ GRIGIO/GREY	x1	80	2,50	mc. 0,005				
17	PINKO-SEDILE ESTERNO PLASTICA PER GIREVOLE E PANCA PINKO-PLASTIC OUTER SEAT FOR SWIVEL AND BENCH	CODICE/CODE	FINITURA/FINISHING	Q. KIT	Q. MIN/PACK	A	B	KG. x1/WT.x1	VOL. x1/UNIT VOL.		
		132203-027	■ NERO/BLACK	x1	20	465	470	0,60	mc. 0,007		
16	TAPPO COPRITESTA ALETTATO D.25 NERO COVER HEAD D.25 BLACK	CODICE/CODE	FINITURA/FINISHING	Q. KIT							
		134103-250	■ NERO/BLACK	x2							
18	PINKO-SEDILE/SCHIENALE IN PLASTICA COLORATO A VISTA PINKO-PLASTIC SEAT/BACK COLOURED AT SIGHT	CODICE/CODE	FINITURA/FINISHING	Q. KIT	Q. MIN/PACK	A	B	C	D	KG. x1/WT.x1	VOL. x1/UNIT VOL.
		134015-108	■ BLU/BLUE 5002	x1	20	470	465	350	495	1,78	mc. 0,014
		134003-108	■ NERO/BLACK	x1	20	470	465	350	495	1,78	mc. 0,014
		134004-109	■ GRIGIO/GREY 7035	x1	20	470	465	350	495	1,78	mc. 0,014
08	PINKO-COPPIA BRACCIOLI DX/SX IN PLASTICA PINKO-PAIR OF PLASTIC ARMS RIGHT/LEFT	CODICE/CODE	FINITURA/FINISHING	Q. KIT	Q. MIN/PACK	KG. x1/WT.x1	VOL. x1/UNIT VOL.				
		131703-050	■ NERO/BLACK	x1	10	0,66	mc. 0,0037				

PER I COMPONENTI DELLA PANCA VAI A PAG. 337
FOR THE BENCH COMPONENTS GO TO PAGE 337

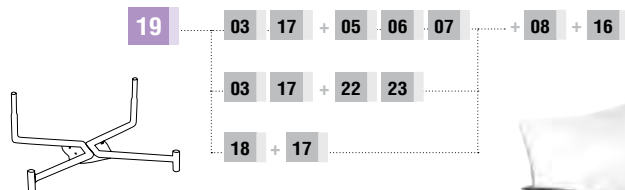

OPTIONAL GAMBA
LEG OPTIONAL



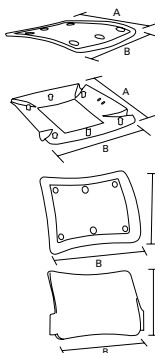

03	PINKO-SEDILE INTERNO DA TAPPEZZARE PINKO-INNER SEAT FOR UPHOLSTERY								
	CODICE/CODE FINITURA/FINISHING	Q. KIT	Q. MIN/PACK	A	B	KG. x1/WT.x1	VOL. x1/UNIT VOL.		
	132203-025 ■ NERO/BLACK	x1	20	465	470	0,73	mc. 0,006		
17	PINKO-SEDILE ESTERNO PLASTICA PER GIREVOLE E PANCA PINKO-PLASTIC OUTER SEAT FOR SWIVEL AND BENCH								
	CODICE/CODE FINITURA/FINISHING	Q. KIT	Q. MIN/PACK	A	B	KG. x1/WT.x1	VOL. x1/UNIT VOL.		
	132203-027 ■ NERO/BLACK	x1	20	465	470	0,60	mc. 0,007		
22	PINKO-SCHIENALE INTERNO DA TAPPEZZARE PINKO-INNER BACK FOR UPHOLSTERY								
	CODICE/CODE FINITURA/FINISHING	Q. KIT	Q. MIN/PACK	A	B	KG. x1/WT.x1	VOL. x1/UNIT VOL.		
	132103-025 ■ NERO/BLACK	x1	20	350	495	0,62	mc. 0,009		
23	PINKO-SCHIENALE ESTERNO PLASTICA PINKO-OUTER PLASTIC BACK								
	CODICE/CODE FINITURA/FINISHING	Q. KIT	Q. MIN/PACK	A	B	KG. x1/WT.x1	VOL. x1/UNIT VOL.		
	132103-026 ■ NERO/BLACK	x1	20	350	495	0,25	mc. 0,0045		

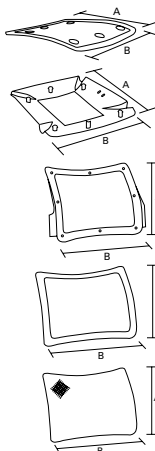

03	PINKO-SEDILE INTERNO DA TAPPEZZARE PINKO-INNER SEAT FOR UPHOLSTERY								
	CODICE/CODE FINITURA/FINISHING	Q. KIT	Q. MIN/PACK	A	B	KG. x1/WT.x1	VOL. x1/UNIT VOL.		
	132203-025 ■ NERO/BLACK	x1	20	465	470	0,73	mc. 0,006		
17	PINKO-SEDILE ESTERNO PLASTICA PER GIREVOLE E PANCA PINKO-PLASTIC OUTER SEAT FOR SWIVEL AND BENCH								
	CODICE/CODE FINITURA/FINISHING	Q. KIT	Q. MIN/PACK	A	B	KG. x1/WT.x1	VOL. x1/UNIT VOL.		
	132203-027 ■ NERO/BLACK	x1	20	465	470	0,60	mc. 0,007		
05	PINKO-TELAIO SCHIENALE IN PLASTICA PER RETE (PORTANTE) PINKO-BACK FRAME IN PLASTIC FOR MESH								
	CODICE/CODE FINITURA/FINISHING	Q. KIT	Q. MIN/PACK	A	B	KG. x1/WT.x1	VOL. x1/UNIT VOL.		
	132103-027 ■ NERO/BLACK	x1	20	345	495	0,50	mc. 0,0045		
06	PINKO-CORNICE SCHIENALE IN PLASTICA PER RETE PINKO-OPEN FRAME IN PLASTIC FOR MESH								
	CODICE/CODE FINITURA/FINISHING	Q. KIT	Q. MIN/PACK	A	B	KG. x1/WT.x1	VOL. x1/UNIT VOL.		
	132103-028 ■ NERO/BLACK	x1	20	345	495	0,35	mc. 0,0057		
07	PINKO-RETE PER SCHIENALE PINKO-NET FOR PINKO BACK								
	CODICE/CODE FINITURA/FINISHING	Q. KIT	Q. MIN/PACK	A	B	KG. x1/WT.x1	VOL. x1/UNIT VOL.		
	132105-501 □ BIANCO/WHITE	x1	25	460	520	0,14	mc. 0,0057		
	132103-501 ■ NERO/BLACK	x1	25	460	520	0,14	mc. 0,0057		
	132104-501 ■ GRIGIO/GREY	x1	25	460	520	0,14	mc. 0,0057		

PINKO FOLDING BENCH



PER I COMPONENTI DELLA PANCA VAI A PAG. 337
FOR THE BENCH COMPONENTS GO TO PAGE 337



OPTIONAL
OPTIONAL
OPTIONAL
OPTIONAL



24	SITON-MECCANISMO PANCA RIBALTABILE ALLUMINIO LUCIDO		Q.KIT	Q.MIN/PACK	A	B	KG.x1/WT.x1	VOL.x1/UNIT VOL.
	SITON-POLISHED ALUMINIUM MECHANISM FOR FOLDING BENCH							
	CODICE/CODE	FINITURA/FINISHING						
	110704-180	■ ALLUMINIO/ALUMINIUM	x1	4	80	40	2,81	mc. 0,007

31	90GF(02)-GAMBA FISSA PER PANCA CON ACCESSORI		Q.KIT	Q.MIN/PACK	A	B	KG.x1/WT.x1	VOL.x1/UNIT VOL.
	90GF(02)-FIXED LEG FOR BENCH WITH ACCESSORIES							
	CODICE/CODE	FINITURA/FINISHING						
	110703-122	■ NERO/BLACK	x2	2	320	310	1,80	mc. 0,0012
	110704-107	■ GRIGIO/GREY	x2	2	320	310	1,80	mc. 0,0012

32	90T(03) TRAVE PER PANCA 80x40		Q.KIT	Q.MIN/PACK	A	B	C	KG.x1/WT.x1	VOL.x1/UNIT VOL.
	90T(03) BEAM FOR BENCH 80x40								
	CODICE/CODE	FINITURA/FINISHING							
	110703-190	■ NERO/BLACK	x1	1	1160	80	40	3,20	mc. 0,0045
	110704-190	■ GRIGIO/GREY	x1	1	1160	80	40	3,20	mc. 0,0045
	110703-191	■ NERO/BLACK	x1	1	1710	80	40	4,71	mc. 0,005
	110704-191	■ GRIGIO/GREY	x1	1	1710	80	40	4,71	mc. 0,005
	110703-192	■ NERO/BLACK	x1	1	2260	80	40	6,22	mc. 0,0085
	110704-192	■ GRIGIO/GREY	x1	1	2260	80	40	6,22	mc. 0,0085
	110703-193	■ NERO/BLACK	x1	1	2800	80	40	7,72	mc. 0,001
	110704-193	■ GRIGIO/GREY	x1	1	2800	80	40	7,72	mc. 0,001

33	VITE TCEI M5X16 BRUNITA NERA (VITE PER FISSAGGIO TELAIO SCHIENALE IN TUBO)		Q.KIT
	SCREW M5X16 CILINDRICAL HEAD HEXAGON EMBEDDED BURNISHING BLACK (SCREW FOR TUBE BACK FRAME FIXING)		
	CODICE/CODE	FINITURA/FINISHING	Q.KIT
	117703-160	■ NERO/BLACK	x4

34	VITE TCEI M6X20 ZINCATA (VITE PER FISSAGGIO SEDILE)		Q.KIT
	SCREW M6X20 CILINDRICAL HEAD HEXAGON EMBEDDED BURNISHING ZINC (SCREW FOR SEAT FIXING)		
	CODICE/CODE	FINITURA/FINISHING	Q.KIT
	117711-198	■ ZINCATA/ZINC	x4

20	PINKO-TELAIO SCHIENALE A U PER PANCA RIBALTABILE		Q.KIT	Q.MIN/PACK	A	B	KG.x1/WT.x1	VOL.x1/UNIT VOL.
	PINKO-FRAME BACK BENCH FOR FOLDING							
	CODICE/CODE	FINITURA/FINISHING						
	110703-071	■ NERO/BLACK	x1	15	300	490	1,40	mc. 0,003
	110704-182	■ GRIGIO/GREY	x1	15	300	490	1,40	mc. 0,003

21	SITON-SEDILE PANCA RIBALTABILE IN LEGNO PER TAPPEZZARE		Q.KIT	Q.MIN/PACK	A	B	KG.x1/WT.x1	VOL.x1/UNIT VOL.
	SITON-BENCH SEAT FOLDING WOODEN FOR UPHOLSTERY							
	CODICE/CODE	FINITURA/FINISHING						
	122207-003	■ GREZZO/RAW	x1	10	420	410	1,30	mc. 0,007

22	PINKO-SCHIENALE INTERNO DA TAPPEZZARE		Q.KIT	Q.MIN/PACK	A	B	KG.x1/WT.x1	VOL.x1/UNIT VOL.
	PINKO-INNER BACK FOR UPHOLSTERY							
	CODICE/CODE	FINITURA/FINISHING						
	132103-025	■ NERO/BLACK	x1	20	350	495	0,62	mc. 0,009

23	PINKO-SCHIENALE ESTERNO PLASTICA		Q.KIT	Q.MIN/PACK	A	B	KG.x1/WT.x1	VOL.x1/UNIT VOL.
	PINKO-OUTER PLASTIC BACK							
	CODICE/CODE	FINITURA/FINISHING						
	132103-026	■ NERO/BLACK	x1	20	350	495	0,25	mc. 0,0045

OPTIONAL

TAVOLETTA TLT TLT TABLET	TAVOLETTA TLT2 TLT2 TABLET	TAVOLETTA TLT3 TLT3 TABLET	TAVOLETTA BEAN BEAN TABLET	TAVOLETTA TL01 TL01 TABLET	SNODO TAVOLETTA SPT2 SPT2 MECHANISM TABLET	SNODO ANTIPANICO MECHANISM ANTIPANIC
VEDI/SEE PAG. 327	VEDI/SEE PAG. 327	VEDI/SEE PAG. 327	VEDI/SEE PAG. 327	VEDI/SEE PAG. 327	VEDI/SEE PAG. 326	VEDI/SEE PAG. 326

FOLDING BENCH OPTIONS:

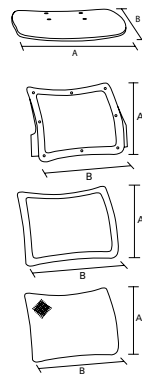
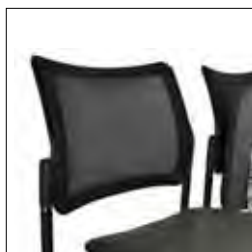

21 SITON-SEDILE PANCA RIBALTABILE IN LEGNO PER TAPPEZZARE SITON-BENCH SEAT FOLDING WOODEN FOR UPHOLSTERY								
CODICE/CODE	FINITURA/FINISHING	Q.KIT	Q.MIN/PACK	A	B	KG.x1/WT.x1	VOL.x1/UNIT VOL.	
122207-003	■ GREZZO/RAW	x1	10	420	410	1,30	mc. 0,007	
05 PINKO-TELAIO SCHIENALE IN PLASTICA PER RETE (PORTANTE) PINKO-BACK FRAME IN PLASTIC FOR MESH								
CODICE/CODE	FINITURA/FINISHING	Q.KIT	Q.MIN/PACK	A	B	KG.x1/WT.x1	VOL.x1/UNIT VOL.	
132103-027	■ NERO/BLACK	x1	20	345	495	0,50	mc. 0,0045	
06 PINKO-CORNICE SCHIENALE IN PLASTICA PER RETE PINKO-OPEN FRAME IN PLASTIC FOR MESH								
CODICE/CODE	FINITURA/FINISHING	Q.KIT	Q.MIN/PACK	A	B	KG.x1/WT.x1	VOL.x1/UNIT VOL.	
132103-028	■ NERO/BLACK	x1	20	345	495	0,35	mc. 0,0057	
07 PINKO-RETE PER SCHIENALE PINKO-NET FOR PINKO BACK								
CODICE/CODE	FINITURA/FINISHING	Q.KIT	Q.MIN/PACK	A	B	KG.x1/WT.x1	VOL.x1/UNIT VOL.	
132105-501	□ BIANCO/WHITE	x1	25	460	520	0,14	mc. 0,0057	
132103-501	■ NERO/BLACK	x1	25	460	520	0,14	mc. 0,0057	
132104-501	■ GRIGIO/GREY	x1	25	460	520	0,14	mc. 0,0057	

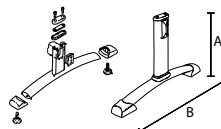

35 90GM(02)-GAMBA MOBILE PER PANCA CON ACCESSORI 90GM(02)-MOVABLE LEG FOR BENCH WITH ACCESSORIES								
CODICE/CODE	FINITURA/FINISHING	Q.KIT	Q.MIN/PACK	A	B	KG.x1/WT.x1	VOL.x1/UNIT VOL.	
110703-120	■ NERO/BLACK	x2	2	320	600	2,70	mc. 0,0012	
110704-099	■ GRIGIO/GREY	x2	2	320	600	2,70	mc. 0,0012	
110710-007	■ CROMATO/CHROME	x2	2	320	600	2,70	mc. 0,0012	

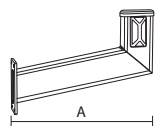

36 300GF(02)- GAMBA FISSA PER PANCA CON SEDUTA RIBALTABILE + ACCESSORI 300GF(02)-FIXED LEG FOR BENCH WITH FOLDING SEAT + ACCESSORIES								
CODICE/CODE	FINITURA/FINISHING	Q.KIT	Q.MIN/PACK	A		KG.x1/WT.x1	VOL.x1/UNIT VOL.	
110703-105	■ NERO/BLACK	x2	2	240		1,45	mc. 0,012	
110704-115	■ GRIGIO/GREY	x2	2	240		1,45	mc. 0,012	

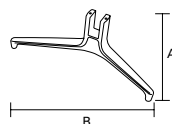

37 SITON(GA02)-GAMBA LUNGA IN ALLUMINIO PER PANCA SITON(GA02)-LONG LEG ALUMINIUM FOR BENCH								
CODICE/CODE	FINITURA/FINISHING	Q.KIT	Q.MIN/PACK	A	B	KG.x1/WT.x1	VOL.x1/UNIT VOL.	
110704-171	■ ALLUMINIO/ALUMINIUM	x2	5	305	643	2,80	mc. 0,014	

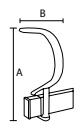

38 SITON-BRACCIOLLO ELLITTICO PER PANCA CON ACCESSORI SITON-ELLIPTICAL ARM FOR BENCH WITH ACCESSORIES								
CODICE/CODE	FINITURA/FINISHING	Q.KIT	Q.MIN/PACK	A	B	KG.x1/WT.x1	VOL.x1/UNIT VOL.	
111710-020	■ CROMATO/CHROME	x1	5	370	340	1,70	mc. 0,015	
111703-019	■ NERO/BLACK	x1	5	370	340	1,70	mc. 0,015	

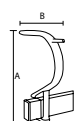

39 SITON-P-BRACCIOLLO ELLITTICO PER PANCA CON GANCIO PORTA TAVOLETTA CON ACCESSORI SITON-P-ELLIPTICAL ARM FOR BENCH WITH TABLE HOOK WITH ACCESSORIES								
CODICE/CODE	FINITURA/FINISHING	Q.KIT	Q.MIN/PACK	A	B	KG.x1/WT.x1	VOL.x1/UNIT VOL.	
111710-017	■ CROMATO/CHROME	x1	5	370	340	1,70	mc. 0,015	
111703-017	■ NERO/BLACK	x1	5	370	340	1,70	mc. 0,015	



Visitor mod





EQUITY

SLIDE

4 LEGS

4 LEGS FOR CASTORS

SWIVEL

BENCH



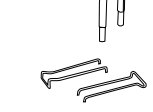
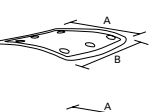
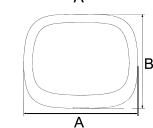
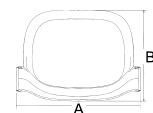
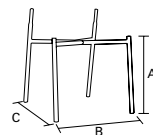
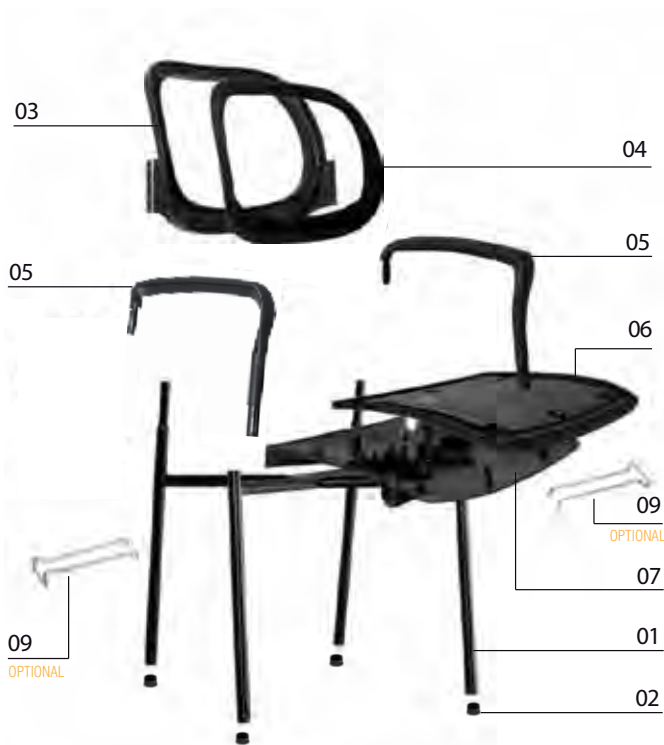

01 PINKO-TELAIO QUATTRO GAMBE FISSO PER BRACCIOLI SENZA TAPPI PINKO-FIXED FOUR LEGS FRAME FOR ARMS WITHOUT CAPS							
CODICE/CODE	FINITURA/FINISHING	Q. KIT	Q. MIN/PACK	A	B	C	KG. x1/WT.x1 VOL. x1/UNIT VOL.
112603-040	■ NERO/BLACK	x1	80	450	530	530	3,20 mc. 0,035
112604-040	■ GRIGIO/GREY	x1	80	450	530	530	3,20 mc. 0,035
112610-040	■ CROMATO/CHROME	x1	80	450	530	530	3,20 mc. 0,035

02 PUNTALE ALETTATO TESTA SFERICA D.25 SPHERICAL CAP D.25							
CODICE/CODE	FINITURA/FINISHING	Q. KIT					
134203-250	■ NERO/BLACK	x4					

03 EQUITY-SCHIENALE PORTANTE PLASTICA EQUITY-PLASTIC BACK BEARING							
CODICE/CODE	FINITURA/FINISHING	Q. KIT	Q. MIN/PACK	A	B	KG. x1/WT.x1	VOL. x1/UNIT VOL.
132103-016	■ NERO/BLACK	x1	10	440	360	0,67	mc. 0,0085
132105-016	□ BIANCO/WHITE	x1	10	440	360	0,67	mc. 0,0085

04 EQUITY-CORNICE SCHIENALE PER RETE EQUITY-PLASTIC OPEN FRAME FOR MESH BACK							
CODICE/CODE	FINITURA/FINISHING	Q. KIT	Q. MIN/PACK	A	B	KG. x1/WT.x1	VOL. x1/UNIT VOL.
132103-018	■ NERO/BLACK	x1	20	425	350	0,36	mc. 0,0045
132105-082	□ BIANCO/WHITE	x1	20	425	350	0,36	mc. 0,0045

05 EQUITY-COPPIA BRACCIOLI PLASTICA EQUITY-PAIR OF PLASTIC ARMREST							
CODICE/CODE	FINITURA/FINISHING	Q. KIT	Q. MIN/PACK	A	B	KG. x1/WT.x1	VOL. x1/UNIT VOL.
131703-052	■ NERO/BLACK	x1	10	375	220	0,87	mc. 0,0062
131705-052	□ BIANCO/WHITE	x1	10	375	220	0,87	mc. 0,0062

06 PINKO-SEDILE INTERNO DA TAPPEZZARE PINKO-INNER SEAT FOR UPHOLSTERY							
CODICE/CODE	FINITURA/FINISHING	Q. KIT	Q. MIN/PACK	A	B	KG. x1/WT.x1	VOL. x1/UNIT VOL.
132203-025	■ NERO/BLACK	x1	20	465	470	0,73	mc. 0,006

07 PINKO-SEDILE ESTERNO PLASTICA PINKO-OUTER PLASTIC SEAT							
CODICE/CODE	FINITURA/FINISHING	Q. KIT	Q. MIN/PACK	A	B	KG. x1/WT.x1	VOL. x1/UNIT VOL.
132203-026	■ NERO/BLACK	x1	20	465	470	0,62	mc. 0,007
132205-026	□ BIANCO/WHITE	x1	20	465	470	0,62	mc. 0,007

08 EQUITY-COPPIA BRACCIOLI PLASTICA CON GANCIO TAVOLETTA DESTRO EQUITY-PAIR OF PLASTIC ARMREST WITH RIGHT JOINT FOR WRITING TABLET							
CODICE/CODE	FINITURA/FINISHING	Q. KIT	Q. MIN/PACK	A	B	KG. x1/WT.x1	VOL. x1/UNIT VOL.
131703-053	■ NERO/BLACK	x1	10	375	220	0,88	mc. 0,0062

09 PINKO-COPPIA AGGANCI LATERALE MASCHIO + FEMMINA CROMATI PINKO-CHROME LATERAL HOOKS MALE + FEMAL WITH SCREWS							
CODICE/CODE	FINITURA/FINISHING	Q. KIT	Q. MIN/PACK	KG. x1/WT.x1	VOL. x1/UNIT VOL.		
113410-100	■ CROMATO/CHROME	x1	100	0,13	mc. 0,0057		

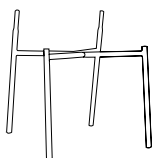
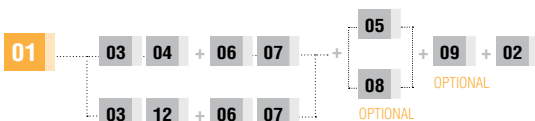

OPTIONAL 08
BRACCIOLO + GANCIO PORTATAVOLETTA
ARMS WITH JOINT FOR WRITING TABLET



OPTIONAL

TAVOLETTA TLT
TLT TABLET



VEDI/SEE PAG. 327

TAVOLETTA TLT2
TLT2 TABLET



VEDI/SEE PAG. 327

TAVOLETTA TLT3
TLT3 TABLET



VEDI/SEE PAG. 327

TAVOLETTA BEAN
BEAN TABLET



VEDI/SEE PAG. 327

TAVOLETTA TL01
TL01 TABLET



VEDI/SEE PAG. 327

SNODO TAVOLETTA SPT2
SPT2 MECHANISM TABLET



VEDI/SEE PAG. 326

SNODO ANTIPANICO
MECHANISM ANTIPANIC



VEDI/SEE PAG. 326

4 LEGS OPTIONS:

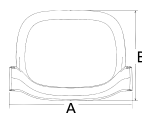

03

EQUITY-SCHIENALE PORTANTE PLASTICA

EQUITY-PLASTIC BACK BEARING

CODICE/CODE	FINITURA/FINISHING	Q. KIT	Q. MIN/PACK	A	B	KG. x1/WT.x1	VOL. x1/UNIT VOL.
132103-016	■ NERO/BLACK	x1	10	440	360	0,67	mc. 0,0085
132105-016	□ BIANCO/WHITE	x1	10	440	360	0,67	mc. 0,0085

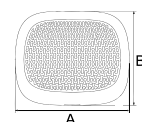

12

EQUITY-PANNELLO SCHIENALE FORATO IN PLASTICA

EQUITY-PLASTIC PANEL FOR MESH BACK

CODICE/CODE	FINITURA/FINISHING	Q. KIT	Q. MIN/PACK	A	B	KG. x1/WT.x1	VOL. x1/UNIT VOL.
132103-017	■ NERO/BLACK	x1	20	425	350	0,45	mc. 0,0045
132106-017	■ NEUTRO/NEUTRAL	x1	20	425	350	0,45	mc. 0,0045

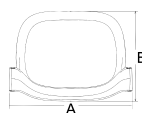

03

EQUITY-SCHIENALE PORTANTE PLASTICA

EQUITY-PLASTIC BACK BEARING

CODICE/CODE	FINITURA/FINISHING	Q. KIT	Q. MIN/PACK	A	B	KG. x1/WT.x1	VOL. x1/UNIT VOL.
132103-016	■ NERO/BLACK	x1	10	440	360	0,67	mc. 0,0085
132105-016	□ BIANCO/WHITE	x1	10	440	360	0,67	mc. 0,0085

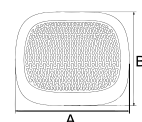

12

EQUITY-PANNELLO SCHIENALE FORATO IN PLASTICA (TAPPEZZABILE)

EQUITY-PLASTIC PANEL FOR MESH BACK (TO BE UPHOLSTERED)

CODICE/CODE	FINITURA/FINISHING	Q. KIT	Q. MIN/PACK	A	B	KG. x1/WT.x1	VOL. x1/UNIT VOL.
132103-017	■ NERO/BLACK	x1	20	425	350	0,45	mc. 0,0045
132106-017	■ NEUTRO/NEUTRAL	x1	20	425	350	0,45	mc. 0,0045

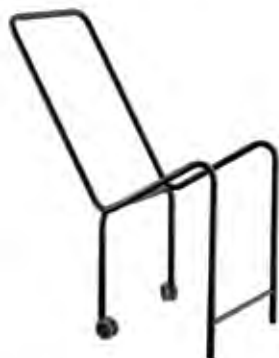

EQUITY-CARRELLO PORTASEDIE CON ACCESSORI NERO

EQUITY-TROLLEY FOR CHAIRS WITH ACCESSORIES BLACK

CODICE/CODE	FINITURA/FINISHING
112603-047	■ NERO/BLACK

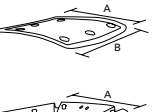
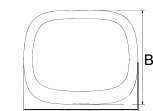
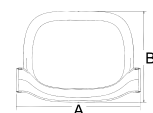
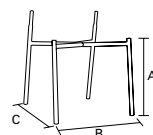
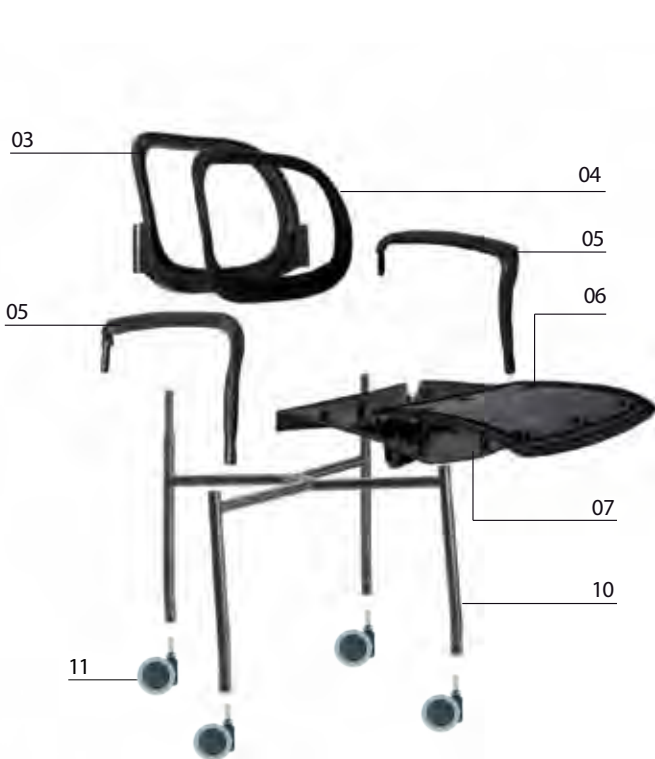

10 PINKO-TELAIO QUATTRO GAMBE PER RUOTE + 4 RIDUTTORI PER RUOTE PINKO FOUR LEGS FRAME FOR CASTORS + 4 ADAPTERS FOR CASTORS									
CODICE/CODE	FINITURA/FINISHING	Q. KIT	Q. MIN/PACK	A	B	C	KG. x1/WT.x1	VOL. x1/UNIT VOL.	
112603-041	■ NERO/BLACK	x1	80	450	530	530	3,20	mc. 0,035	
112604-041	■ GRIGIO/GREY	x1	80	450	530	530	3,20	mc. 0,035	
112610-041	■ CROMATO/CHROME	x1	80	450	530	530	3,20	mc. 0,035	

11 DOPPIA RUOTA D.50 IN DESMOPAN CON PERNO MONTATO TWIN WHEEL CASTOR D.50 DESMOPAN WITH PIVOT MOUNTED									
CODICE/CODE	FINITURA/FINISHING	Q. KIT							
134403-003	■ NERO/BLACK	x4							

03 EQUITY-SCHIENALE PORTANTE PLASTICA EQUITY-PLASTIC BACK BEARING									
CODICE/CODE	FINITURA/FINISHING	Q. KIT	Q. MIN/PACK	A	B	KG. x1/WT.x1	VOL. x1/UNIT VOL.		
132103-016	■ NERO/BLACK	x1	10	440	360	0,67	mc. 0,0085		
132105-016	□ BIANCO/WHITE	x1	10	440	360	0,67	mc. 0,0085		

04 EQUITY-CORNICE SCHIENALE PER RETE EQUITY-PLASTIC OPEN FRAME FOR MESH BACK									
CODICE/CODE	FINITURA/FINISHING	Q. KIT	Q. MIN/PACK	A	B	KG. x1/WT.x1	VOL. x1/UNIT VOL.		
132103-018	■ NERO/BLACK	x1	20	425	350	0,36	mc. 0,0045		
132105-082	□ BIANCO/WHITE	x1	20	425	350	0,36	mc. 0,0045		

05 EQUITY-COPPIA BRACCIOLI PLASTICA EQUITY-PAIR OF PLASTIC ARMREST									
CODICE/CODE	FINITURA/FINISHING	Q. KIT	Q. MIN/PACK	A	B	KG. x1/WT.x1	VOL. x1/UNIT VOL.		
131703-052	■ NERO/BLACK	x1	10	375	220	0,87	mc. 0,0062		
131705-052	□ BIANCO/WHITE	x1	10	375	220	0,87	mc. 0,0062		

06 PINKO-SEDILE INTERNO DA TAPPEZZARE PINKO-INNER SEAT FOR UPHOLSTERY									
CODICE/CODE	FINITURA/FINISHING	Q. KIT	Q. MIN/PACK	A	B	KG. x1/WT.x1	VOL. x1/UNIT VOL.		
132203-025	■ NERO/BLACK	x1	20	465	470	0,73	mc. 0,006		

07 PINKO-SEDILE ESTERNO PLASTICA PINKO-OUTER PLASTIC SEAT									
CODICE/CODE	FINITURA/FINISHING	Q. KIT	Q. MIN/PACK	A	B	KG. x1/WT.x1	VOL. x1/UNIT VOL.		
132203-026	■ NERO/BLACK	x1	20	465	470	0,62	mc. 0,007		
132205-026	□ BIANCO/WHITE	x1	20	465	470	0,62	mc. 0,007		

08 EQUITY-COPPIA BRACCIOLI PLASTICA CON GANCIO TAVOLETTA DESTRO EQUITY-PAIR OF PLASTIC ARMREST WITH RIGHT JOINT FOR WRITING TABLET									
CODICE/CODE	FINITURA/FINISHING	Q. KIT	Q. MIN/PACK	A	B	KG. x1/WT.x1	VOL. x1/UNIT VOL.		
131703-053	■ NERO/BLACK	x1	10	375	220	0,88	mc. 0,0062		

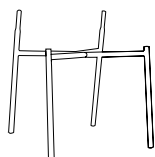
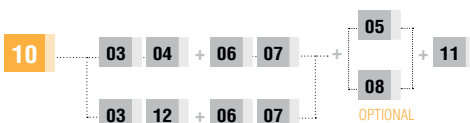

OPTIONAL 08
BRACCIOLO + GANCIO PORTATAVOLETTA
ARMS WITH JOINT FOR WRITING TABLET



OPTIONAL

TAVOLETTA TLT TLT TABLET	TAVOLETTA TLT2 TLT2 TABLET	TAVOLETTA TLT3 TLT3 TABLET	TAVOLETTA BEAN BEAN TABLET	TAVOLETTA TL01 TL01 TABLET	SNODO TAVOLETTA SPT2 SPT2 MECHANISM TABLET	SNODO ANTIPANICO MECHANISM ANTIPANIC
VEDI/SEE PAG. 327	VEDI/SEE PAG. 327	VEDI/SEE PAG. 327	VEDI/SEE PAG. 327	VEDI/SEE PAG. 327	VEDI/SEE PAG. 326	VEDI/SEE PAG. 326

4 LEGS FOR CASTORS OPTIONS:

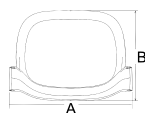

03

EQUITY-SCHIENALE PORTANTE PLASTICA

EQUITY-PLASTIC BACK BEARING

CODICE/CODE	FINITURA/FINISHING	Q. KIT	Q. MIN/PACK	A	B	KG. x1/WT.x1	VOL. x1/UNIT VOL.
132103-016	■ NERO/BLACK	x1	10	440	360	0,67	mc. 0,0085
132105-016	□ BIANCO/WHITE	x1	10	440	360	0,67	mc. 0,0085

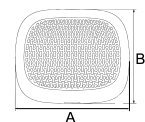

12

EQUITY-PANNELLO SCHIENALE FORATO IN PLASTICA

EQUITY-PLASTIC PANEL FOR MESH BACK

CODICE/CODE	FINITURA/FINISHING	Q. KIT	Q. MIN/PACK	A	B	KG. x1/WT.x1	VOL. x1/UNIT VOL.
132103-017	■ NERO/BLACK	x1	20	425	350	0,45	mc. 0,0045
132106-017	■ NEUTRO/NEUTRAL	x1	20	425	350	0,45	mc. 0,0045

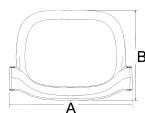

03

EQUITY-SCHIENALE PORTANTE PLASTICA

EQUITY-PLASTIC BACK BEARING

CODICE/CODE	FINITURA/FINISHING	Q. KIT	Q. MIN/PACK	A	B	KG. x1/WT.x1	VOL. x1/UNIT VOL.
132103-016	■ NERO/BLACK	x1	10	440	360	0,67	mc. 0,0085
132105-016	□ BIANCO/WHITE	x1	10	440	360	0,67	mc. 0,0085

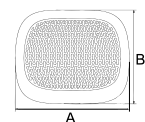

12

EQUITY-PANNELLO SCHIENALE FORATO IN PLASTICA (TAPPEZZABILE)

EQUITY-PLASTIC PANEL FOR MESH BACK (TO BE UPHOLSTERED)

CODICE/CODE	FINITURA/FINISHING	Q. KIT	Q. MIN/PACK	A	B	KG. x1/WT.x1	VOL. x1/UNIT VOL.
132103-017	■ NERO/BLACK	x1	20	425	350	0,45	mc. 0,0045
132106-017	■ NEUTRO/NEUTRAL	x1	20	425	350	0,45	mc. 0,0045

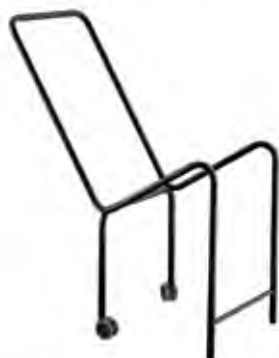

EQUITY-CARRELLO PORTASEDIE CON ACCESSORI NERO

EQUITY-TROLLEY FOR CHAIRS WITH ACCESSORIES BLACK

CODICE/CODE	FINITURA/FINISHING
112603-047	■ NERO/BLACK

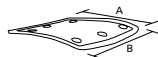
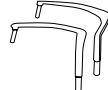
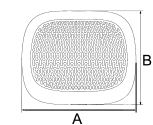
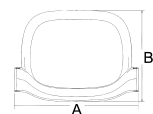
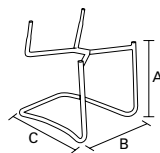

13 PINKO-BASE A SLITTA IN TUBO ASFORM D.25 TAPPI ESCLUSI PINKO-SLIDE FRAME PIPE D.25 WITHOUT CAPS									
CODICE/CODE	FINITURA/FINISHING	Q.KIT	Q.MIN/PACK	A	B	C	KG.x1/WT.x1	VOL.x1/UNIT VOL.	
110503-093	■ NERO/BLACK	x1	40	450	550	550	4,60	mc. 0,06	
110504-093	■ GRIGIO/GREY	x1	40	450	550	550	4,60	mc. 0,06	
110510-093	■ CROMATO/CHROME	x1	40	450	550	550	4,60	mc. 0,06	

14 PARACOLPI TESTA BOMBATA D.18 ROUND HEAD CAP D.18									
CODICE/CODE	FINITURA/FINISHING	Q.KIT							
134403-101	■ NERO/BLACK	x4							

03 EQUITY-SCHIENALE PORTANTE PLASTICA EQUITY-PLASTIC BACK BEARING									
CODICE/CODE	FINITURA/FINISHING	Q.KIT	Q.MIN/PACK	A	B	KG.x1/WT.x1	VOL.x1/UNIT VOL.		
132103-016	■ NERO/BLACK	x1	10	440	360	0,67	mc. 0,0085		
132105-016	□ BIANCO/WHITE	x1	10	440	360	0,67	mc. 0,0085		

12 EQUITY-PANNELLO SCHIENALE FORATO IN PLASTICA EQUITY-PLASTIC PANEL FOR MESH BACK									
CODICE/CODE	FINITURA/FINISHING	Q.KIT	Q.MIN/PACK	A	B	KG.x1/WT.x1	VOL.x1/UNIT VOL.		
132103-017	■ NERO/BLACK	x1	20	425	350	0,45	mc. 0,0045		
132106-017	■ NEUTRO/NEUTRAL	x1	20	425	350	0,45	mc. 0,0045		

05 EQUITY-COPPIA BRACCIOLI PLASTICA EQUITY-PAIR OF PLASTIC ARMEREST									
CODICE/CODE	FINITURA/FINISHING	Q.KIT	Q.MIN/PACK	A	B	KG.x1/WT.x1	VOL.x1/UNIT VOL.		
131703-052	■ NERO/BLACK	x1	10	375	220	0,87	mc. 0,0062		
131705-052	□ BIANCO/WHITE	x1	10	375	220	0,87	mc. 0,0062		

06 PINKO-SEDILE INTERNO DA TAPPEZZARE PINKO-INNER SEAT FOR UPHOLSTERY									
CODICE/CODE	FINITURA/FINISHING	Q.KIT	Q.MIN/PACK	A	B	KG.x1/WT.x1	VOL.x1/UNIT VOL.		
132203-025	■ NERO/BLACK	x1	20	465	470	0,73	mc. 0,006		

07 PINKO-SEDILE ESTERNO PLASTICA PINKO-OUTER PLASTIC SEAT									
CODICE/CODE	FINITURA/FINISHING	Q.KIT	Q.MIN/PACK	A	B	KG.x1/WT.x1	VOL.x1/UNIT VOL.		
132203-026	■ NERO/BLACK	x1	20	465	470	0,62	mc. 0,007		
132205-026	□ BIANCO/WHITE	x1	20	465	470	0,62	mc. 0,007		

13 03 04 + 06 07 + 05 + 14

03 12 + 06 07

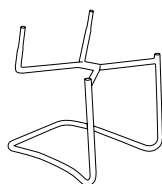

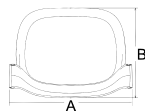

03 EQUITY-SCHIENALE PORTANTE PLASTICA		EQUITY-PLASTIC BACK BEARING							
CODICE/CODE	FINITURA/FINISHING	Q. KIT	Q. MIN/PACK	A	B	KG. x1/WT.x1	VOL. x1/UNIT VOL.		
132103-016	■ NERO/BLACK	x1	10	440	360	0,67	mc. 0,0085		
132105-016	□ BIANCO/WHITE	x1	10	440	360	0,67	mc. 0,0085		

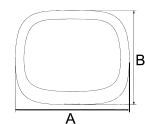

04 EQUITY-CORNICE SCHIENALE PER RETE		EQUITY-PLASTIC OPEN FRAME FOR MESH BACK							
CODICE/CODE	FINITURA/FINISHING	Q. KIT	Q. MIN/PACK	A	B	KG. x1/WT.x1	VOL. x1/UNIT VOL.		
132103-018	■ NERO/BLACK	x1	20	425	350	0,36	mc. 0,0045		
132105-082	□ BIANCO/WHITE	x1	20	425	350	0,36	mc. 0,0045		

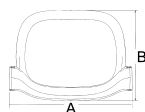

03 EQUITY-SCHIENALE PORTANTE PLASTICA		EQUITY-PLASTIC BACK BEARING							
CODICE/CODE	FINITURA/FINISHING	Q. KIT	Q. MIN/PACK	A	B	KG. x1/WT.x1	VOL. x1/UNIT VOL.		
132103-016	■ NERO/BLACK	x1	10	440	360	0,67	mc. 0,0085		
132105-016	□ BIANCO/WHITE	x1	10	440	360	0,67	mc. 0,0085		

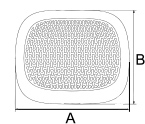

12 EQUITY-PANNELLO SCHIENALE FORATO IN PLASTICA (TAPPEZZABILE)		EQUITY-PLASTIC PANEL FOR MESH BACK (TO BE UPHOLSTERED)							
CODICE/CODE	FINITURA/FINISHING	Q. KIT	Q. MIN/PACK	A	B	KG. x1/WT.x1	VOL. x1/UNIT VOL.		
132103-017	■ NERO/BLACK	x1	20	425	350	0,45	mc. 0,0045		
132106-017	■ NEUTRO/NEUTRAL	x1	20	425	350	0,45	mc. 0,0045		

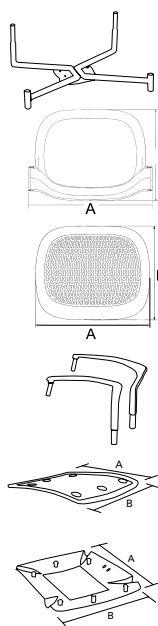

15	PINKO-TELAIO PER GIREVOLE COMANDO A GAS SENZA TAPPI PINKO-SWIVEL FRAME WITH GAS LEVER WITHOUT CAPS	Q. KIT	Q. MIN/PACK		KG. x1/WT.x1	VOL. x1/UNIT VOL.
	CODICE/CODE FINITURA/FINISHING					
	112603-045 ■ NERO/BLACK	x1	80		2,60	mc. 0,005
	112604-045 ■ GRIGIO/GREY	x1	80		2,60	mc. 0,005
03	EQUITY-SCHIENALE PORTANTE PLASTICA EQUITY-PLASTIC BACK BEARING	Q. KIT	Q. MIN/PACK	A B	KG. x1/WT.x1	VOL. x1/UNIT VOL.
	CODICE/CODE FINITURA/FINISHING					
	132103-016 ■ NERO/BLACK	x1	10	440 360	0,67	mc. 0,0085
	132105-016 □ BIANCO/WHITE	x1	10	440 360	0,67	mc. 0,0085
12	EQUITY-PANNELLO SCHIENALE FORATO IN PLASTICA (TAPPEZZABILE) EQUITY-PLASTIC PANEL FOR MESH BACK (TO BE UPHOLSTERED)	Q. KIT	Q. MIN/PACK	A B	KG. x1/WT.x1	VOL. x1/UNIT VOL.
	CODICE/CODE FINITURA/FINISHING					
	132103-017 ■ NERO/BLACK	x1	20	425 350	0,45	mc. 0,0045
	132106-017 ■ NEUTRO/NEUTRAL	x1	20	425 350	0,45	mc. 0,0045
05	EQUITY-COPPIA BRACCIOLI PLASTICA EQUITY-PAIR OF PLASTIC ARMEREST	Q. KIT	Q. MIN/PACK	A B	KG. x1/WT.x1	VOL. x1/UNIT VOL.
	CODICE/CODE FINITURA/FINISHING					
	131703-052 ■ NERO/BLACK	x1	10	375 220	0,87	mc. 0,0062
	131705-052 □ BIANCO/WHITE	x1	10	375 220	0,87	mc. 0,0062
06	PINKO-SEDILE INTERNO DA TAPPEZZARE PINKO-INNER SEAT FOR UPHOLSTERY	Q. KIT	Q. MIN/PACK	A B	KG. x1/WT.x1	VOL. x1/UNIT VOL.
	CODICE/CODE FINITURA/FINISHING					
	132203-025 ■ NERO/BLACK	x1	20	465 470	0,73	mc. 0,006
16	PINKO-SEDILE ESTERNO PLASTICA PER GIREVOLE E PANCA PINKO-PLASTIC OUTER SEAT FOR SWIVEL AND BENCH	Q. KIT	Q. MIN/PACK	A B	KG. x1/WT.x1	VOL. x1/UNIT VOL.
	CODICE/CODE FINITURA/FINISHING					
	132203-027 ■ NERO/BLACK	x1	20	465 470	0,62	mc. 0,007

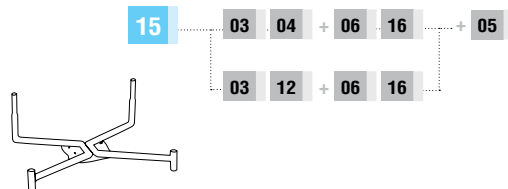

SWIVEL OPTIONS:

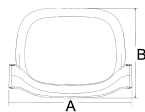

03 EQUITY-SCHIENALE PORTANTE PLASTICA		EQUITY-PLASTIC BACK BEARING		Q. KIT	Q. MIN/PACK	A	B	KG. x1/WT.x1	VOL. x1/UNIT VOL.
132103-016	■ NERO/BLACK	x1	10	440	360	0,67	mc. 0,0085		
132105-016	□ BIANCO/WHITE	x1	10	440	360	0,67	mc. 0,0085		

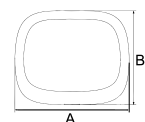

04 EQUITY-CORNICE SCHIENALE PER RETE		EQUITY-PLASTIC OPEN FRAME FOR MESH BACK		Q. KIT	Q. MIN/PACK	A	B	KG. x1/WT.x1	VOL. x1/UNIT VOL.
132103-018	■ NERO/BLACK	x1	20	425	350	0,36	mc. 0,0045		
132105-082	□ BIANCO/WHITE	x1	20	425	350	0,36	mc. 0,0045		

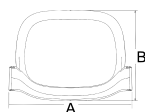

03 EQUITY-SCHIENALE PORTANTE PLASTICA		EQUITY-PLASTIC BACK BEARING		Q. KIT	Q. MIN/PACK	A	B	KG. x1/WT.x1	VOL. x1/UNIT VOL.
132103-016	■ NERO/BLACK	x1	10	440	360	0,67	mc. 0,0085		
132105-016	□ BIANCO/WHITE	x1	10	440	360	0,67	mc. 0,0085		

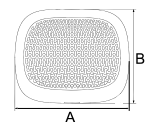

12 EQUITY-PANNELLO SCHIENALE FORATO IN PLASTICA		EQUITY-PLASTIC PANEL FOR MESH BACK		Q. KIT	Q. MIN/PACK	A	B	KG. x1/WT.x1	VOL. x1/UNIT VOL.
132103-017	■ NERO/BLACK	x1	20	425	350	0,45	mc. 0,0045		
132106-017	■ NEUTRO/NEUTRAL	x1	20	425	350	0,45	mc. 0,0045		



PER I COMPONENTI DELLA PANCA VAI A PAG. 337
FOR THE BENCH COMPONENTS GO TO PAGE 337

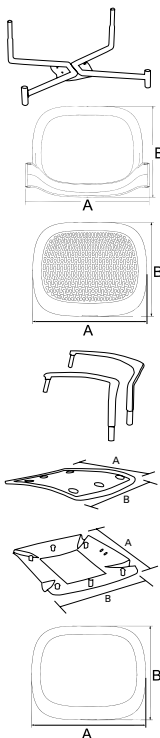

17	PINKO-TELAIO PER PANCA SENZA TAPPI PINKO-BENCH FRAME CAPS EXCLUDED		Q. KIT	Q. MIN/PACK	KG. x1/WT.x1	VOL. x1/UNIT VOL.		
	CODICE/CODE	FINITURA/FINISHING						
	110703-072	■ NERO/BLACK	x1	80	2,50	mc. 0,005		
	110704-072	■ GRIGIO/GREY	x1	80	2,50	mc. 0,005		
03	EQUITY-SCHIENALE PORTANTE PLASTICA EQUITY-PLASTIC BACK BEARING		Q. KIT	Q. MIN/PACK	A	B	KG. x1/WT.x1	VOL. x1/UNIT VOL.
	CODICE/CODE	FINITURA/FINISHING						
	132103-016	■ NERO/BLACK	x1	10	440	360	0,67	mc. 0,0085
	132105-016	□ BIANCO/WHITE	x1	10	440	360	0,67	mc. 0,0085
12	EQUITY-PANNELLO SCHIENALE FORATO IN PLASTICA (TAPPEZZABILE) EQUITY-PLASTIC PANEL FOR MESH BACK (TO BE UPHOLSTERED)		Q. KIT	Q. MIN/PACK	A	B	KG. x1/WT.x1	VOL. x1/UNIT VOL.
	CODICE/CODE	FINITURA/FINISHING						
	132103-017	■ NERO/BLACK	x1	20	425	350	0,45	mc. 0,0045
	132106-017	■ NEUTRO/NEUTRAL	x1	20	425	350	0,45	mc. 0,0045
05	EQUITY-COPPIA BRACCIOLI PLASTICA EQUITY-PAIR OF PLASTIC ARMREST		Q. KIT	Q. MIN/PACK	A	B	KG. x1/WT.x1	VOL. x1/UNIT VOL.
	CODICE/CODE	FINITURA/FINISHING						
	131703-052	■ NERO/BLACK	x1	10	375	220	0,87	mc. 0,0062
	131705-052	□ BIANCO/WHITE	x1	10	375	220	0,87	mc. 0,0062
06	PINKO-SEDILE INTERNO DA TAPPEZZARE PINKO-INNER SEAT FOR UPHOLSTERY		Q. KIT	Q. MIN/PACK	A	B	KG. x1/WT.x1	VOL. x1/UNIT VOL.
	CODICE/CODE	FINITURA/FINISHING						
	132203-025	■ NERO/BLACK	x1	20	465	470	0,73	mc. 0,006
16	PINKO-SEDILE ESTERNO PLASTICA PER GIREVOLE E PANCA PINKO-PLASTIC OUTER SEAT FOR SWIVEL AND BENCH		Q. KIT	Q. MIN/PACK	A	B	KG. x1/WT.x1	VOL. x1/UNIT VOL.
	CODICE/CODE	FINITURA/FINISHING						
	132203-027	■ NERO/BLACK	x1	20	465	470	0,62	mc. 0,007
04	EQUITY-CORNICE SCHIENALE PER RETE EQUITY-PLASTIC OPEN FRAME FOR MESH BACK		Q. KIT	Q. MIN/PACK	A	B	KG. x1/WT.x1	VOL. x1/UNIT VOL.
	CODICE/CODE	FINITURA/FINISHING						
	132103-018	■ NERO/BLACK	x1	20	425	350	0,36	mc. 0,0045
	132105-082	□ BIANCO/WHITE	x1	20	425	350	0,36	mc. 0,0045

17 + 03 + 04 + 06 + 16 + 05

03 + 12 + 06 + 16

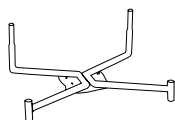

OPTIONAL GAMBA LEG OPTIONAL





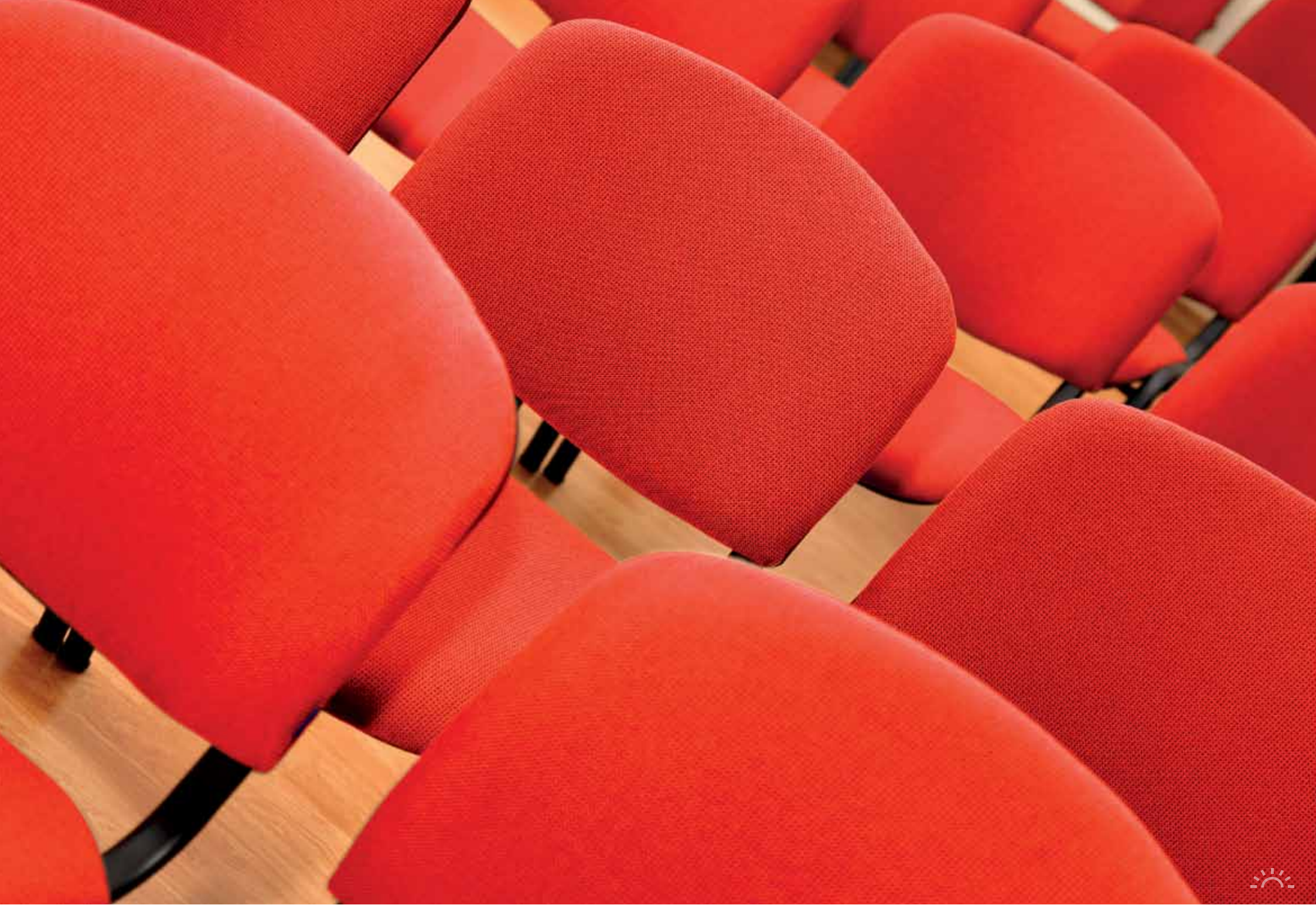



SLIDE



4 LEGS



SWIVEL

90



SLIDE



4 LEGS



4 LEGS



BENCH



02
OPTIONAL

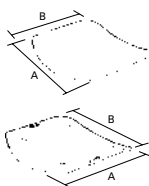
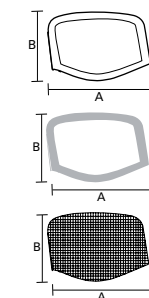
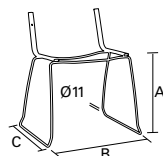

01	SPRITZ-TELAIO CHIUSO IN TONDINO D.11 TAPPI ESCLUSI SPRITZ-SLED WIRE FRAME D.11 CAPS EXCLUDED								
CODICE/CODE	FINITURA/FINISHING	Q. KIT	Q. MIN/PACK	A	B	C	KG.x1/WT.x1	VOL.x1/UNIT VOL.	
112010-250	■ CROMATO/CHROME	x1	50	450	580	470	4,00	mc. 0,042	
02	BASE PIANA A PINZA IN PE PER TONDO CLIPS BASE FOR TUBE								
CODICE/CODE	FINITURA/FINISHING	Q. KIT							
134006-020	■ NEUTRO/NEUTRAL	x4							
09	BASE PIANA A PINZA IN PE PER TONDO UNIONE SEDIE DOUBLE FLAT CLIPS BASE FOR TUBE								
CODICE/CODE	FINITURA/FINISHING	Q. KIT							
134006-021	■ NEUTRO/NEUTRAL	x4							
03	ISONET-TELAIO SCHIENALE IN PLASTICA CON VITI PER RETE ISONET-OUTER FRAME WITH SCREWS FOR NET								
CODICE/CODE	FINITURA/FINISHING	Q. KIT	Q. MIN/PACK	A	B		KG.x1/WT.x1	VOL.x1/UNIT VOL.	
132103-003	■ NERO/BLACK	x1	25	470	345		0,42	mc. 0,006	
04	ISONET-CORNICE SCHIENALE IN PLASTICA PER RETE ISONET-OPEN FRAME FOR ISONET MODEL								
CODICE/CODE	FINITURA/FINISHING	Q. KIT	Q. MIN/PACK	A	B		KG.x1/WT.x1	VOL.x1/UNIT VOL.	
132103-004	■ NERO/BLACK	x1	25	470	345		0,31	mc. 0,004	
05	ISONET-RETE PER SCHIENALE ISONET-NET FOR BACK								
CODICE/CODE	FINITURA/FINISHING	Q. KIT	Q. MIN/PACK	A	B		KG.x1/WT.x1	VOL.x1/UNIT VOL.	
132105-500	□ BIANCO/WHITE	x1	25	550	400		0,14	mc. 0,0057	
132103-500	■ NERO/BLACK	x1	25	550	400		0,14	mc. 0,0057	
132102-500	■ ROSSO/RED	x1	25	550	400		0,14	mc. 0,0057	
06	90SDI-SEDILE INTERNO IN PLASTICA 90SDI-INNER PLASTIC FOR METAL FRAME								
CODICE/CODE	FINITURA/FINISHING	Q. KIT	Q. MIN/PACK	A	B		KG.x1/WT.x1	VOL.x1/UNIT VOL.	
132203-002	■ NERO/BLACK	x1	30	460	400		0,80	mc. 0,004	
07	90SDE-SOTTOSEDILE ESTERNO PLASTICA 90SDE-OUTER PLASTIC SEAT FOR METAL FRAME								
CODICE/CODE	FINITURA/FINISHING	Q. KIT	Q. MIN/PACK	A	B		KG.x1/WT.x1	VOL.x1/UNIT VOL.	
132203-001	■ NERO/BLACK	x1	80	410	465		0,40	mc. 0,003	
23	VITE TESTA SVASATA A CROCE M6X20 BRUNITA NERA SCREW FLARED CROSS HEAD M6X20 BURNISHING BLACK								
CODICE/CODE	FINITURA/FINISHING	Q. KIT							
117703-184	■ NERO/BLACK	x4							

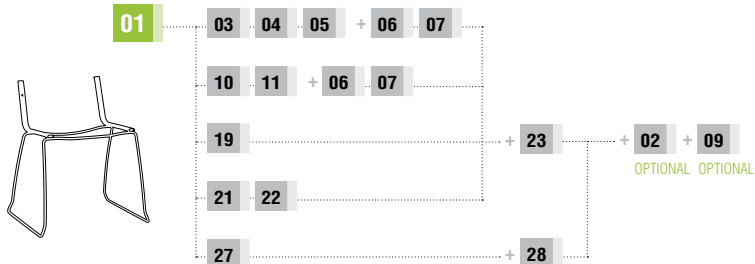

OPTIONAL 02
BASE PIANA A PINZA
CLIPS BASE



OPTIONAL 09
BASE PIANA A PINZA DOPPIA
DOUBLE FLAT CLIP BASE



SLIDE OPTIONS:

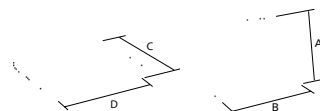
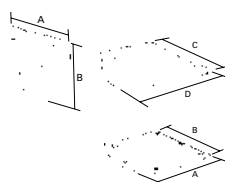
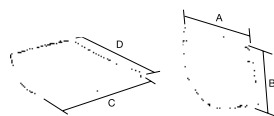
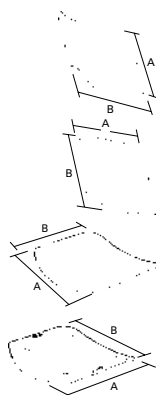

10 90SHI-SCHIENALE INTERNO IN PLASTICA									
90SHI-PLASTIC INTERNAL BACKREST									
CODICE/CODE	FINITURA/FINISHING	Q. KIT	Q. MIN/PACK	A	B	KG. x1/WT.x1	VOL. x1/UNIT VOL.		
132103-002	■ NERO/BLACK	x1	40	330	470	0,60	mc. 0,004		

11 90SHE-COPRISCHIENALE ESTERNO IN PLASTICA									
90SHE-EXTERNAL PLASTIC BACKREST COVER									
CODICE/CODE	FINITURA/FINISHING	Q. KIT	Q. MIN/PACK	A	B	KG. x1/WT.x1	VOL. x1/UNIT VOL.		
132103-001	■ NERO/BLACK	x1	30	475	335	0,40	mc. 0,004		

06 90SDI-SEDILE INTERNO IN PLASTICA									
90SDI-INNER PLASTIC FOR METAL FRAME									
CODICE/CODE	FINITURA/FINISHING	Q. KIT	Q. MIN/PACK	A	B	KG. x1/WT.x1	VOL. x1/UNIT VOL.		
132203-002	■ NERO/BLACK	x1	30	460	400	0,80	mc. 0,004		

07 90SDE-SOTTOSEDILE ESTERNO PLASTICA									
90SDE-OUTER PLASTIC SEAT FOR METAL FRAME									
CODICE/CODE	FINITURA/FINISHING	Q. KIT	Q. MIN/PACK	A	B	KG. x1/WT.x1	VOL. x1/UNIT VOL.		
132203-001	■ NERO/BLACK	x1	80	410	465	0,40	mc. 0,003		

19 NOVX-SEDILE E SCHIENALE IN PLASTICA DISPONIBILI PER TELAIO IN TUBO OVALE E IN TUBO ELLITTICO									
NOVX-PLASTIC SEAT AND BACKREST AVAILABLE FOR OVAL OR ELLIPTIC TUBE FRAME									
CODICE/CODE	FINITURA/FINISHING	Q. KIT	Q. MIN/PACK	A	B	C	D	KG. x1/WT.x1	VOL. x1/UNIT VOL.
134002-001	■ ROSSO/RED RAL3002	x1	20	470	315	460	400	1,21	mc. 0,008
134003-119	■ NERO/BLACK RAL9005	x1	20	470	315	460	400	1,21	mc. 0,008
134015-003	■ BLU/BLUE RAL5002	x1	20	470	315	460	400	1,21	mc. 0,008

21 PRISMA-SCHIENALE E SEDILE IN PLASTICA DISPONIBILI PER TELAIO IN TUBO OVALE E IN TUBO ELLITTICO									
PRISMA-PLASTIC BACKREST AND SEAT AVAILABLE FOR OVAL OR ELLIPTIC TUBE FRAME									
CODICE/CODE	FINITURA/FINISHING	Q. KIT	Q. MIN/PACK	A	B	C	D	KG. x1/WT.x1	VOL. x1/UNIT VOL.
134003-110	■ NERO/BLACK	x1	10	470	330	460	430	1,60	mc. 0,016

22 PRISMA-PANNELLO SEDILE DA TAPPEZZARE									
PRISMA-SEAT PANEL TO UPHOLSTER									
CODICE/CODE	FINITURA/FINISHING	Q. KIT	Q. MIN/PACK	A	B	KG. x1/WT.x1	VOL. x1/UNIT VOL.		
132203-010	■ NERO/BLACK	x1	20	400	400	0,40	mc. 0,004		

27 90SHSDF-SCHIENALE + SEDILE MULTISTRATO VERNICIATO FAGGIO + 4 TESTINE									
90SHSDF-BACKREST + SEAT IN PAINTED PLANED BEECH PLYWOOD									
CODICE/CODE	FINITURA/FINISHING	Q. KIT	Q. MIN/PACK	A	B	C	D	KG. x1/WT.x1	VOL. x1/UNIT VOL.
124007-000	■ FAGGIO/BEECH-WOOD	x1	10	330	465	400	465	2,70	mc. 0,07

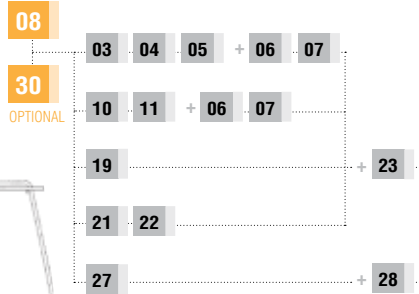

08 92-TELAIO PER SEDIA IN TUBO OVALE 30x15 CON TAPPI LATERALI E SOTTOPIEDE MONTATI
92-CHAIR FRAME IN 30X15 OVAL TUBE WITH SIDE AND FOOT CAPS MOUNTED

CODICE/CODE	FINITURA/FINISHING	ATT.BRACC./ARM ATTACH	Q.KIT	Q.MIN/PACK	A	B	KG.x1/WT.x1	VOL.x1/UNIT VOL.
112003-005	■ NERO/BLACK	12	x1	160	450	425	3,00	mc. 0,021
112003-004	■ NERO/BLACK	14	x1	160	450	425	3,00	mc. 0,021
112004-000	■ GRIGIO/GREY	12	x1	160	450	425	3,00	mc. 0,021
112004-002	■ GRIGIO/GREY	14	x1	160	450	425	3,00	mc. 0,021
112010-008	■ CROMATO/CHROME	12	x1	160	450	425	3,00	mc. 0,021
112010-005	■ CROMATO/CHROME	14	x1	160	450	425	3,00	mc. 0,021

30 92-TELAIO PER SEDIA IN TUBO OVALE 30x15 CON AGGANCIAMENTO LATERALE IN METALLO SALDATO, CON TAPPI LATERALI E SOTTOPIEDE MONTATI
92-CHAIR FRAME IN 30X15 OVAL TUBE WITH METAL LATERAL HOOK WELDED, SIDE AND FOOT CAPS MOUNTED

CODICE/CODE	FINITURA/FINISHING	ATT.BRACC./ARM ATTACH	Q.KIT	Q.MIN/PACK	A	B	KG.x1/WT.x1	VOL.x1/UNIT VOL.
112003-016	■ NERO/BLACK	12	x1	160	450	425	3,00	mc. 0,021
112003-015	■ NERO/BLACK	14	x1	160	450	425	3,00	mc. 0,021
112004-007	■ GRIGIO/GREY	12	x1	160	450	425	3,00	mc. 0,021
112004-008	■ GRIGIO/GREY	14	x1	160	450	425	3,00	mc. 0,021
112010-016	■ CROMATO/CHROME	12	x1	160	450	425	3,00	mc. 0,021
112010-015	■ CROMATO/CHROME	14	x1	160	450	425	3,00	mc. 0,021

10 90SHI-SCHIENALE INTERNO IN PLASTICA
90SHI-PLASTIC INTERNAL BACKREST

CODICE/CODE	FINITURA/FINISHING	Q.KIT	Q.MIN/PACK	A	B	KG.x1/WT.x1	VOL.x1/UNIT VOL.
132103-002	■ NERO/BLACK	x1	40	330	470	0,60	mc. 0,004

11 90SHE-COPRISCHIENALE ESTERNO IN PLASTICA
90SHE-EXTERNAL PLASTIC BACKREST COVER

CODICE/CODE	FINITURA/FINISHING	Q.KIT	Q.MIN/PACK	A	B	KG.x1/WT.x1	VOL.x1/UNIT VOL.
132103-001	■ NERO/BLACK	x1	30	475	335	0,40	mc. 0,004

06 90SDI-SEDILE INTERNO IN PLASTICA
90SDI-INNER PLASTIC FOR METAL FRAME

CODICE/CODE	FINITURA/FINISHING	Q.KIT	Q.MIN/PACK	A	B	KG.x1/WT.x1	VOL.x1/UNIT VOL.
132203-002	■ NERO/BLACK	x1	30	460	400	0,80	mc. 0,004

07 90SDE-SOTTOSEDILE ESTERNO PLASTICA
90SDE-OUTER PLASTIC SEAT FOR METAL FRAME

CODICE/CODE	FINITURA/FINISHING	Q.KIT	Q.MIN/PACK	A	B	KG.x1/WT.x1	VOL.x1/UNIT VOL.
132203-001	■ NERO/BLACK	x1	80	410	465	0,40	mc. 0,003

12 90B-BRACCIOLINO IN NYLON 90BP-BRACCIOLINO IN NYLON CON AGGANCIAMENTO PORTA TAVOLETTA
90B-NYLON ARMREST 90BP-WITH WRITING TABLET HOOK

CODICE/CODE	FINITURA/FINISHING	ATT.BRACC./ARM ATTACH	Q.KIT	Q.MIN/PACK	A	B	C	D	KG.x1/WT.x1	VOL.x1/UNIT VOL.
90BP14	■ NERO/BLACK	14*	x1	20	290	250	190	15x15	0,80	mc. 0,0026
90B14	■ NERO/BLACK	14	x2	20	290	250	190		0,80	mc. 0,0026
90BP	■ NERO/BLACK	12*	x1	20	290	250	190	15x15	0,80	mc. 0,0026
90B	■ NERO/BLACK	12	x2	20	290	250	190		0,80	mc. 0,0026

* GANCIO TAV./HOOK TABLE

13 SPT2-SNODO PER TAVOLETTA IN TERMOPLASTICA
SPT2-THERMOPLASTIC WRITING TABLET ARTICULATION

CODICE/CODE	FINITURA/FINISHING	Q.KIT	Q.MIN/PACK	A	B	C	KG.x1/WT.x1	VOL.x1/UNIT VOL.
134003-039	■ NERO/BLACK	x1	20	180	66	15x15	0,35	mc. 0,0006

14 BEAN-TAVOLETTA IN TERMOPLASTICO SPESSORE 16 mm
BEAN-16MM THICK THERMOPLASTIC WRITING TABLET

CODICE/CODE	FINITURA/FINISHING	Q.KIT	Q.MIN/PACK	A	B	KG.x1/WT.x1	VOL.x1/UNIT VOL.
134003-044	■ NERO/BLACK	x1	20	235	370	0,40	mc. 0,002

17 92C-CESTELLO PORTARIVISTE
92C-MAGAZINE RACK

CODICE/CODE	FINITURA/FINISHING	Q.KIT	Q.MIN/PACK	KG.x1/WT.x1	VOL.x1/UNIT VOL.
113403-001	■ NERO/BLACK	x1	25	0,975	mc. 0,03
113410-020	■ CROMATO/CHROME	x1	25	0,975	mc. 0,03

18 COPPIA PINZE REGOLABILI PER TUBO OVALE 15X30 PP
CLIPS FOR OVAL TUBE 15X30 PP

CODICE/CODE	FINITURA/FINISHING	Q.KIT	Q.MIN/PACK	A	B
134003-002	■ NERO/BLACK	x1	200	214	134

23 VITE TESTA SVASATA A CROCE M6X20 BRUNITA NERA
SCREW FLARED CROSS HEAD M6X20 BURNISHING BLACK

CODICE/CODE	FINITURA/FINISHING	Q.KIT
117703-184	■ NERO/BLACK	x4

OPTIONAL 29

AGGANCIAMENTO LATERALE MASCHIO-FEMMINA IN PLASTICA CON 2 VITI
PLASTIC LATERAL HOOK MALE-FEMALE WITH 2 SCREWS
134003-132 ■ NERO/BLACK



4 LEGS OPTIONS:

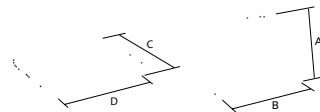
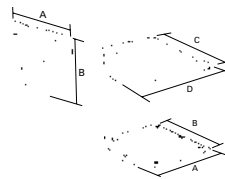
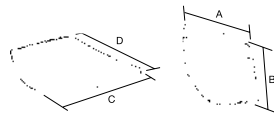
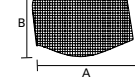
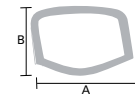

03 ISONET-TELAIO SCHIENALE IN PLASTICA CON VITI PER RETE									
ISONET-OUTER FRAME WITH SCREWS FOR NET									
CODICE/CODE	FINITURA/FINISHING	Q. KIT	Q. MIN/PACK	A	B	KG. x1/WT.x1	VOL. x1/UNIT VOL.		
132103-003	■ NERO/BLACK	x1	25	470	345	0,42	mc. 0,006		

04 ISONET-CORNICE SCHIENALE IN PLASTICA PER RETE									
ISONET-OPEN FRAME FOR ISONET MODEL									
CODICE/CODE	FINITURA/FINISHING	Q. KIT	Q. MIN/PACK	A	B	KG. x1/WT.x1	VOL. x1/UNIT VOL.		
132103-004	■ NERO/BLACK	x1	25	470	345	0,31	mc. 0,004		

05 ISONET-RETE PER SCHIENALE									
ISONET-NET FOR BACK									
CODICE/CODE	FINITURA/FINISHING	Q. KIT	Q. MIN/PACK	A	B	KG. x1/WT.x1	VOL. x1/UNIT VOL.		
132105-500	□ BIANCO/WHITE	x1	25	550	400	0,14	mc. 0,0057		
132103-500	■ NERO/BLACK	x1	25	550	400	0,14	mc. 0,0057		
132102-500	■ ROSSO/RED	x1	25	550	400	0,14	mc. 0,0057		

06 90SDI-SEDILE INTERNO IN PLASTICA									
90SDI-INNER PLASTIC FOR METAL FRAME									
CODICE/CODE	FINITURA/FINISHING	Q. KIT	Q. MIN/PACK	A	B	KG. x1/WT.x1	VOL. x1/UNIT VOL.		
132203-002	■ NERO/BLACK	x1	30	460	400	0,80	mc. 0,004		

07 90SDE-SOTTOSEDILE ESTERNO PLASTICA									
90SDE-OUTER PLASTIC SEAT FOR METAL FRAME									
CODICE/CODE	FINITURA/FINISHING	Q. KIT	Q. MIN/PACK	A	B	KG. x1/WT.x1	VOL. x1/UNIT VOL.		
132203-001	■ NERO/BLACK	x1	80	410	465	0,40	mc. 0,003		

19 NOVX-SEDILE E SCHIENALE IN PLASTICA DISPONIBILI PER TELAIO IN TUBO OVALE E IN TUBO ELLITTICO									
NOVX-PLASTIC SEAT AND BACKREST AVAILABLE FOR OVAL OR ELLIPTIC TUBE FRAME									
CODICE/CODE	FINITURA/FINISHING	Q. KIT	Q. MIN/PACK	A	B	C	D	KG. x1/WT.x1	VOL. x1/UNIT VOL.
134002-001	■ ROSSO/RED RAL3002	x1	20	470	315	460	400	1,21	mc. 0,008
134003-119	■ NERO/BLACK RAL9005	x1	20	470	315	460	400	1,21	mc. 0,008
134015-003	■ BLU/BLUE RAL5002	x1	20	470	315	460	400	1,21	mc. 0,008

21 PRISMA-SCHIENALE E SEDILE IN PLASTICA DISPONIBILI PER TELAIO IN TUBO OVALE E IN TUBO ELLITTICO									
PRISMA-PLASTIC BACKREST AND SEAT AVAILABLE FOR OVAL OR ELLIPTIC TUBE FRAME									
CODICE/CODE	FINITURA/FINISHING	Q. KIT	Q. MIN/PACK	A	B	C	D	KG. x1/WT.x1	VOL. x1/UNIT VOL.
134003-110	■ NERO/BLACK	x1	10	470	330	460	430	1,60	mc. 0,016

22 PRISMA-PANNELLO SEDILE DA TAPPEZZARE									
PRISMA-SEAT PANEL TO UPHOLSTER									
CODICE/CODE	FINITURA/FINISHING	Q. KIT	Q. MIN/PACK	A	B	KG. x1/WT.x1	VOL. x1/UNIT VOL.		
132203-010	■ NERO/BLACK	x1	20	400	400	0,40	mc. 0,004		

27 90SHSDLF-SCHIENALE + SEDILE MULTISTRATO VERNICIATO FAGGIO + 4 TESTINE									
90SHSDLF-BACKREST + SEAT IN PAINTED PLANED BEECH PLYWOOD									
CODICE/CODE	FINITURA/FINISHING	Q. KIT	Q. MIN/PACK	A	B	C	D	KG. x1/WT.x1	VOL. x1/UNIT VOL.
124007-000	■ FAGGIO/BEECH-WOOD	x1	10	330	465	400	465	2,70	mc. 0,07

OPTIONAL

TAVOLETTA TL1
TL1 TABLET



VEDI/SEE PAG. 327

TAVOLETTA TL2
TL2 TABLET



VEDI/SEE PAG. 327

TAVOLETTA TL3
TL3 TABLET



VEDI/SEE PAG. 327

TAVOLETTA BEAN
BEAN TABLET



VEDI/SEE PAG. 327

TAVOLETTA TL01
TL01 TABLET



VEDI/SEE PAG. 327

SNODO TAVOLETTA SPT2
SPT2 MECHANISM TABLET



VEDI/SEE PAG. 326

SNODO ANTIPANICO
MECHANISM ANTIPANIC



VEDI/SEE PAG. 326

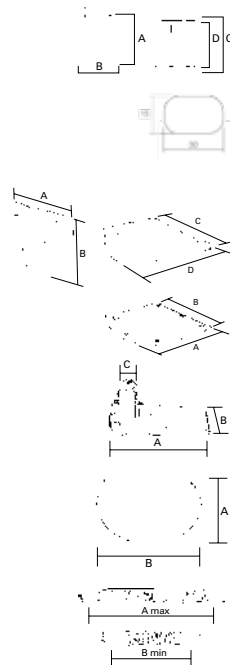

20 94-TELAIO PER SEDIA IN TUBO OVALE 30x15 CON BRACCIOLI CON TAPPI LATERALI E SOTTOPIEDE MONTATI
94-CHAIR FRAME IN 30X15 OVAL TUBE WITH ARMRESTS, SIDE AND FOOT CAPS MOUNTED

CODICE/CODE	FINITURA/FINISHING	Q. KIT	Q. MIN/PACK	A	B	C	D	KG.x1/WT.x1	VOL.x1/UNIT VOL.
112003-020	■ NERO/BLACK	x1	80	450	470	545	425	3,80	mc. 0,042
112004-021	■ GRIGIO/GREY	x1	80	450	470	545	425	3,80	mc. 0,042
112010-040	■ CROMATO/CHROME	x1	80	450	470	545	425	3,80	mc. 0,042
* 112003-022	■ NERO/BLACK	x1	80	450	470	545	425	3,80	mc. 0,042
* 112004-022	■ GRIGIO/GREY	x1	80	450	470	545	425	3,80	mc. 0,042
* 112010-043	■ CROMATO/CHROME	x1	80	450	470	545	425	3,80	mc. 0,042

* GANCIO TAV./HOOK TABLE

21 PRISMA-SCHIENALE E SEDILE IN PLASTICA DISPONIBILI PER TELAIO IN TUBO OVALE E IN TUBO ELLITTICO
PRISMA-PLASTIC BACKREST AND SEAT AVAILABLE FOR OVAL OR ELLIPTIC TUBE FRAME

CODICE/CODE	FINITURA/FINISHING	Q. KIT	Q. MIN/PACK	A	B	C	D	KG.x1/WT.x1	VOL.x1/UNIT VOL.
134003-110	■ NERO/BLACK	x1	10	470	330	460	430	1,60	mc. 0,016

22 PRISMA-PANNELLO SEDILE DA TAPPEZZARE
PRISMA-SEAT PANEL TO UPHOLSTER

CODICE/CODE	FINITURA/FINISHING	Q. KIT	Q. MIN/PACK	A	B	KG.x1/WT.x1	VOL.x1/UNIT VOL.
132203-010	■ NERO/BLACK	x1	20	400	400	0,40	mc. 0,004

13 SPT2-SNODO PER TAVOLETTA IN TERMOPLASTICA
SPT2-THERMOPLASTIC WRITING TABLET ARTICULATION

CODICE/CODE	FINITURA/FINISHING	Q. KIT	Q. MIN/PACK	A	B	C	KG.x1/WT.x1	VOL.x1/UNIT VOL.
134003-039	■ NERO/BLACK	x1	20	180	66	15x15	0,35	mc. 0,0006

14 BEAN-TAVOLETTA IN TERMOPLASTICO SPESSORE 16 mm
BEAN-16MM THICK THERMOPLASTIC WRITING TABLET

CODICE/CODE	FINITURA/FINISHING	Q. KIT	Q. MIN/PACK	A	B	KG.x1/WT.x1	VOL.x1/UNIT VOL.
134003-044	■ NERO/BLACK	x1	20	235	370	0,40	mc. 0,002

18 COPPIA PINZE REGOLABILI PER TUBO OVALE 15X30 PP
CLIPS FOR OVAL TUBE 15X30 PP

CODICE/CODE	FINITURA/FINISHING	Q. KIT	Q. MIN/PACK	A	B
134003-002	■ NERO/BLACK	x1	200	214	134

23 VITE TESTA SVASATA A CROCE M6X20 BRUNITA NERA
SCREW FLARED CROSS HEAD M6X20 BURNISHING BLACK

CODICE/CODE	FINITURA/FINISHING	Q. KIT
117703-184	■ NERO/BLACK	x4

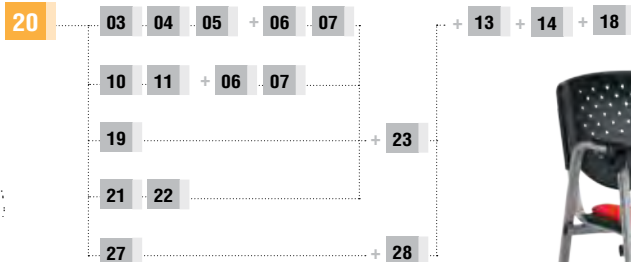

OPTIONAL

TAVOLETTA TLT TLT TABLET	TAVOLETTA TLT2 TLT2 TABLET	TAVOLETTA TLT3 TLT3 TABLET	TAVOLETTA BEAN BEAN TABLET	TAVOLETTA TL01 TL01 TABLET	SNODO TAVOLETTA SPT2 SPT2 MECHANISM TABLET	SNODO ANTIPANICO MECHANISM ANTIPANIC
VEDI/SEE PAG. 327	VEDI/SEE PAG. 327	VEDI/SEE PAG. 327	VEDI/SEE PAG. 327	VEDI/SEE PAG. 327	VEDI/SEE PAG. 326	VEDI/SEE PAG. 326

4 LEGS OPTIONS:

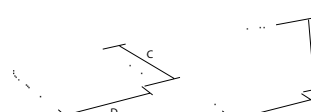
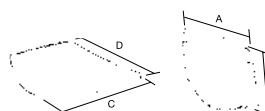
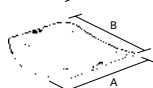
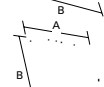
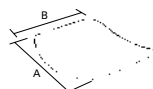

03 ISONET-TELAIO SCHIENALE IN PLASTICA CON VITI PER RETE									
ISONET-OUTER FRAME WITH SCREWS FOR NET									
CODICE/CODE	FINITURA/FINISHING	Q. KIT	Q. MIN/PACK	A	B	KG. x1/WT.x1	VOL. x1/UNIT VOL.		
132103-003	■ NERO/BLACK	x1	25	470	345	0,42	mc. 0,006		

04 ISONET-CORNICE SCHIENALE IN PLASTICA PER RETE									
ISONET-OPEN FRAME FOR ISONET MODEL									
CODICE/CODE	FINITURA/FINISHING	Q. KIT	Q. MIN/PACK	A	B	KG. x1/WT.x1	VOL. x1/UNIT VOL.		
132103-004	■ NERO/BLACK	x1	25	470	345	0,31	mc. 0,004		

05 ISONET-RETE PER SCHIENALE									
ISONET-NET FOR BACK									
CODICE/CODE	FINITURA/FINISHING	Q. KIT	Q. MIN/PACK	A	B	KG. x1/WT.x1	VOL. x1/UNIT VOL.		
132105-500	□ BIANCO/WHITE	x1	25	550	400	0,14	mc. 0,0057		
132103-500	■ NERO/BLACK	x1	25	550	400	0,14	mc. 0,0057		
132102-500	■ ROSSO/RED	x1	25	550	400	0,14	mc. 0,0057		

06 90SDI-SEDILE INTERNO IN PLASTICA									
90SDI-INNER PLASTIC FOR METAL FRAME									
CODICE/CODE	FINITURA/FINISHING	Q. KIT	Q. MIN/PACK	A	B	KG. x1/WT.x1	VOL. x1/UNIT VOL.		
132203-002	■ NERO/BLACK	x1	30	460	400	0,80	mc. 0,004		

07 90SDE-SOTTOSEDILE ESTERNO PLASTICA									
90SDE-OUTER PLASTIC SEAT FOR METAL FRAME									
CODICE/CODE	FINITURA/FINISHING	Q. KIT	Q. MIN/PACK	A	B	KG. x1/WT.x1	VOL. x1/UNIT VOL.		
132203-001	■ NERO/BLACK	x1	80	410	465	0,40	mc. 0,003		

10 90SHI-SCHIENALE INTERNO IN PLASTICA									
90SHI-PLASTIC INTERNAL BACKREST									
CODICE/CODE	FINITURA/FINISHING	Q. KIT	Q. MIN/PACK	A	B	KG. x1/WT.x1	VOL. x1/UNIT VOL.		
132103-002	■ NERO/BLACK	x1	40	330	470	0,60	mc. 0,004		

11 90SHE-COPRISCHIENALE ESTERNO IN PLASTICA									
90SHE-EXTERNAL PLASTIC BACKREST COVER									
CODICE/CODE	FINITURA/FINISHING	Q. KIT	Q. MIN/PACK	A	B	KG. x1/WT.x1	VOL. x1/UNIT VOL.		
132103-001	■ NERO/BLACK	x1	30	475	335	0,40	mc. 0,004		

06 90SDI-SEDILE INTERNO IN PLASTICA									
90SDI-INNER PLASTIC FOR METAL FRAME									
CODICE/CODE	FINITURA/FINISHING	Q. KIT	Q. MIN/PACK	A	B	KG. x1/WT.x1	VOL. x1/UNIT VOL.		
132203-002	■ NERO/BLACK	x1	30	460	400	0,80	mc. 0,004		

07 90SDE-SOTTOSEDILE ESTERNO PLASTICA									
90SDE-OUTER PLASTIC SEAT FOR METAL FRAME									
CODICE/CODE	FINITURA/FINISHING	Q. KIT	Q. MIN/PACK	A	B	KG. x1/WT.x1	VOL. x1/UNIT VOL.		
132203-001	■ NERO/BLACK	x1	80	410	465	0,40	mc. 0,003		

19 NOVX-SEDILE E SCHIENALE IN PLASTICA DISPONIBILI PER TELAIO IN TUBO OVALE E IN TUBO ELLITTICO									
NOVX-PLASTIC SEAT AND BACKREST AVAILABLE FOR OVAL OR ELLIPTIC TUBE FRAME									
CODICE/CODE	FINITURA/FINISHING	Q. KIT	Q. MIN/PACK	A	B	C	D	KG. x1/WT.x1	VOL. x1/UNIT VOL.
134002-001	■ ROSSO/RED RAL3002	x1	20	470	315	460	400	1,21	mc. 0,008
134003-119	■ NERO/BLACK RAL9005	x1	20	470	315	460	400	1,21	mc. 0,008
134015-003	■ BLU/BLUE RAL5002	x1	20	470	315	460	400	1,21	mc. 0,008

27 90SHSDLF-SCHIENALE + SEDILE MULTISTRATO VERNICIATO FAGGIO + 4 TESTINE									
90SHSDLF-BACKREST + SEAT IN PAINTED PLANED BEECH PLYWOOD									
CODICE/CODE	FINITURA/FINISHING	Q. KIT	Q. MIN/PACK	A	B	C	D	KG. x1/WT.x1	VOL. x1/UNIT VOL.
124007-000	■ FAGGIO/BEECH-WOOD	x1	10	330	465	400	465	2,70	mc. 0,07

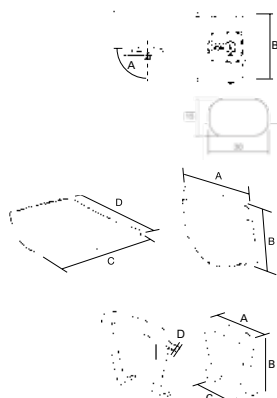

24 92GV-TELAIO PER SEDIA GIREVOLE IN TUBO OVALE 30x15 CON PIASTRA COMANDO A GAS COMPRESO DI SPATOLA, TAPPI ESCLUSI
 92GV-SWIVEL CHAIR FRAME IN 30X15 OVAL TUBE WITH GAS CONTROL PLATE INCL. SPATULA, EXCLUDING CAPS

CODICE/CODE	FINITURA/FINISHING	ATT.BRACC./ARM ATTACH	Q.KIT	Q.MIN/PACK	A	B	KG.x1/WT.x1	VOL.x1/UNIT VOL.
112003-200	■ NERO/BLACK	14	x1	200	87°	425	2,50	mc. 0,015
112003-201	■ NERO/BLACK	12	x1	200	87°	425	2,50	mc. 0,015
112010-200	■ CROMATO/CHROME	14	x1	200	87°	425	2,50	mc. 0,015
112010-201	■ CROMATO/CHROME	12	x1	200	87°	425	2,50	mc. 0,015

19 NOVX-SEDILE E SCHIENALE IN PLASTICA DISPONIBILI PER TELAIO IN TUBO OVALE E IN TUBO ELLITTICO
 NOVX-PLASTIC SEAT AND BACKREST AVAILABLE FOR OVAL OR ELLIPTIC TUBE FRAME

CODICE/CODE	FINITURA/FINISHING	ATT.BRACC./ARM ATTACH	Q.KIT	Q.MIN/PACK	A	B	C	D	KG.x1/WT.x1	VOL.x1/UNIT VOL.
134002-001	■ ROSSO/RED	RAL3002	x1	20	470	315	460	400	1,21	mc. 0,008
134003-119	■ NERO/BLACK	RAL9005	x1	20	470	315	460	400	1,21	mc. 0,008
134015-003	■ BLU/BLUE	RAL5002	x1	20	470	315	460	400	1,21	mc. 0,008

12 90B-BRACCIOLO IN NYLON 90BP-BRACCIOLO IN NYLON CON AGGANCIO PORTA TAVOLETTA
 90B-NYLON ARMREST 90BP-WITH WRITING TABLET HOOK

CODICE/CODE	FINITURA/FINISHING	ATT.BRACC./ARM ATTACH	Q.KIT	Q.MIN/PACK	A	B	C	D	KG.x1/WT.x1	VOL.x1/UNIT VOL.
90BP14 131703-001	■ NERO/BLACK	14*	x1	20	290	250	190	15x15	0,80	mc. 0,0026
90B14 131703-002	■ NERO/BLACK	14	x2	20	290	250	190		0,80	mc. 0,0026
90BP 131703-003	■ NERO/BLACK	12*	x1	20	290	250	190	15x15	0,80	mc. 0,0026
90B 131703-004	■ NERO/BLACK	12	x2	20	290	250	190		0,80	mc. 0,0026

* GANCIO TAV./HOOK TABLE

26 TAPPO COPRITESTA
 COVER HEAD CAP

CODICE/CODE	FINITURA/FINISHING	DIAMETRO/DIAMETER	Q.KIT
134103-180	■ NERO/BLACK	Ø 18	x4
134103-151	■ NERO/BLACK	Ø 15	x4

30 TAPPO COPRITESTA OVALE 30x15
 OVAL COVER HEAD CAP 30x15

CODICE/CODE	FINITURA/FINISHING	Q.KIT
134103-002	■ NERO/BLACK	x2 PLASTICS / x4 WOOD

23 VITE TESTA SVASATA A CROCE M6X20 BRUNITA NERA
 SCREW FLARED CROSS HEAD M6X20 BURNISHING BLACK

CODICE/CODE	FINITURA/FINISHING	Q.KIT
117703-184	■ NERO/BLACK	x4

172
90

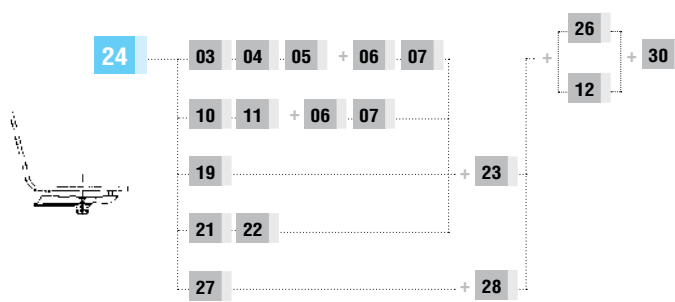

SWIVEL OPTIONS:

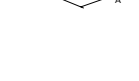
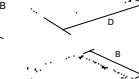
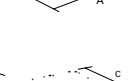
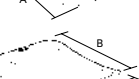
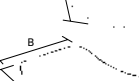

03 ISONET-TELAIO SCHIENALE IN PLASTICA CON VITI PER RETE
ISONET-OUTER FRAME WITH SCREWS FOR NET

CODICE/CODE	FINITURA/FINISHING	Q. KIT	Q. MIN/PACK	A	B	KG. x1/WT.x1	VOL. x1/UNIT VOL.
132103-003	■ NERO/BLACK	x1	25	470	345	0,42	mc. 0,006

04 ISONET-CORNICE SCHIENALE IN PLASTICA PER RETE
ISONET-OPEN FRAME FOR ISONET MODEL

CODICE/CODE	FINITURA/FINISHING	Q. KIT	Q. MIN/PACK	A	B	KG. x1/WT.x1	VOL. x1/UNIT VOL.
132103-004	■ NERO/BLACK	x1	25	470	345	0,31	mc. 0,004

05 ISONET-NET PER SCHIENALE
ISONET-NET FOR BACK

CODICE/CODE	FINITURA/FINISHING	Q. KIT	Q. MIN/PACK	A	B	KG. x1/WT.x1	VOL. x1/UNIT VOL.
132105-500	□ BIANCO/WHITE	x1	25	550	400	0,14	mc. 0,0057
132103-500	■ NERO/BLACK	x1	25	550	400	0,14	mc. 0,0057
132102-500	■ ROSSO/RED	x1	25	550	400	0,14	mc. 0,0057

06 90SDI-SEDILE INTERNO IN PLASTICA
90SDI-INNER PLASTIC FOR METAL FRAME

CODICE/CODE	FINITURA/FINISHING	Q. KIT	Q. MIN/PACK	A	B	KG. x1/WT.x1	VOL. x1/UNIT VOL.
132203-002	■ NERO/BLACK	x1	30	460	400	0,80	mc. 0,004

07 90SDE-SOTTOSEDILE ESTERNO PLASTICA
90SDE-OUTER PLASTIC SEAT FOR METAL FRAME

CODICE/CODE	FINITURA/FINISHING	Q. KIT	Q. MIN/PACK	A	B	KG. x1/WT.x1	VOL. x1/UNIT VOL.
132203-001	■ NERO/BLACK	x1	80	410	465	0,40	mc. 0,003

10 90SHI-SCHIENALE INTERNO IN PLASTICA
90SHI-PLASTIC INTERNAL BACKREST

CODICE/CODE	FINITURA/FINISHING	Q. KIT	Q. MIN/PACK	A	B	KG. x1/WT.x1	VOL. x1/UNIT VOL.
132103-002	■ NERO/BLACK	x1	40	330	470	0,60	mc. 0,004

11 90SHE-COPRISCHIENALE ESTERNO IN PLASTICA
90SHE-EXTERNAL PLASTIC BACKREST COVER

CODICE/CODE	FINITURA/FINISHING	Q. KIT	Q. MIN/PACK	A	B	KG. x1/WT.x1	VOL. x1/UNIT VOL.
132103-001	■ NERO/BLACK	x1	30	475	335	0,40	mc. 0,004

06 90SDI-SEDILE INTERNO IN PLASTICA
90SDI-INNER PLASTIC FOR METAL FRAME

CODICE/CODE	FINITURA/FINISHING	Q. KIT	Q. MIN/PACK	A	B	KG. x1/WT.x1	VOL. x1/UNIT VOL.
132203-002	■ NERO/BLACK	x1	30	460	400	0,80	mc. 0,004

07 90SDE-SOTTOSEDILE ESTERNO PLASTICA
90SDE-OUTER PLASTIC SEAT FOR METAL FRAME

CODICE/CODE	FINITURA/FINISHING	Q. KIT	Q. MIN/PACK	A	B	KG. x1/WT.x1	VOL. x1/UNIT VOL.
132203-001	■ NERO/BLACK	x1	80	410	465	0,40	mc. 0,003

21 PRISMA-SCHIENALE E SEDILE IN PLASTICA DISPONIBILI PER TELAIO IN TUBO OVALE E IN TUBO ELLITTICO
PRISMA-PLASTIC BACKREST AND SEAT AVAILABLE FOR OVAL OR ELLIPTIC TUBE FRAME

CODICE/CODE	FINITURA/FINISHING	Q. KIT	Q. MIN/PACK	A	B	C	D	KG. x1/WT.x1	VOL. x1/UNIT VOL.
134003-110	■ NERO/BLACK	x1	10	470	330	460	430	1,60	mc. 0,016

22 PRISMA-PANNELLO SEDILE DA TAPPEZZARE
PRISMA-SEAT PANEL TO UPHOLSTER

CODICE/CODE	FINITURA/FINISHING	Q. KIT	Q. MIN/PACK	A	B	KG. x1/WT.x1	VOL. x1/UNIT VOL.
132203-010	■ NERO/BLACK	x1	20	400	400	0,40	mc. 0,004

27 90SHSDLF-SCHIENALE + SEDILE MULTISTRATO VERNICIATO FAGGIO + 4 TESTINE
90SHSDLF-BACKREST + SEAT IN PAINTED PLANED BEECH PLYWOOD

CODICE/CODE	FINITURA/FINISHING	Q. KIT	Q. MIN/PACK	A	B	C	D	KG. x1/WT.x1	VOL. x1/UNIT VOL.
124007-000	■ FAGGIO/BEECH-WOOD	x1	10	330	465	400	465	2,70	mc. 0,07

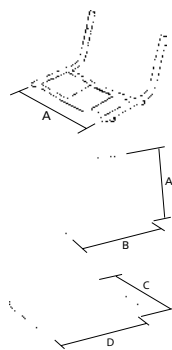

PER I COMPONENTI DELLA PANCA VAI A PAG. 337
FOR THE BENCH COMPONENTS GO TO PAGE 337

25	92PV-TELAIO IN TUBO OVALE O ELITTICO PER PANCA VERNICIATA 92PV-OVAL OR ELIPTIC TUBE FRAME FOR PAINTED BENCH							
CODICE/CODE	FINITURA/FINISHING	ATT. BRACC./ARM ATTACH	Q. KIT	Q. MIN/PACK	A	KG. x1/WT.x1	VOL. x1/UNIT VOL.	
110703-061	■ NERO/BLACK	12 OVALE/OVAL	x1	200	425	2,20	mc. 0,015	
110703-062	■ NERO/BLACK	14 OVALE/OVAL	x1	200	425	2,20	mc. 0,015	
27	90SHSDLF-SCHIENALE + SEDILE MULTISTRATO VERNICIATO FAGGIO + 4 TESTINE 90SHSDLF-BACKREST + SEAT IN PAINTED PLANED BEECH PLYWOOD							
CODICE/CODE	FINITURA/FINISHING		Q. KIT	Q. MIN/PACK	A	B	C	D
124007-000	■ FAGGIO/BEECH-WOOD		x1	10	330	465	400	465
					KG. x1/WT.x1			VOL. x1/UNIT VOL.
					2,70			mc. 0,07
26	TAPPO COPRITESTA COVER HEAD CAP							
CODICE/CODE	FINITURA/FINISHING	DIAMETRO/DIAMETER	Q. KIT					
134103-180	■ NERO/BLACK	Ø 18	x4					
134103-151	■ NERO/BLACK	Ø 15	x4					
30	TAPPO COPRITESTA OVALE 30x15 OVAL COVER HEAD CAP 30x15							
CODICE/CODE	FINITURA/FINISHING	Q. KIT						
134103-002	■ NERO/BLACK	x2 PLASTICS / x4 WOOD						
28	VITE TESTA SVASATA CROCE M6x16 BRUNITA NERA-FISSAGGIO SEDILE/ SCHIENALE FAGGIO M6x16 BLACK BURNISHED FLARED PHILIPS SCREW-BEECH SEAT/BACKREST FIXING							
CODICE/CODE	FINITURA/FINISHING	Q. KIT						
117703-195	■ NERO/BLACK	x4						

OPTIONAL GAMBA
LEG OPTIONAL

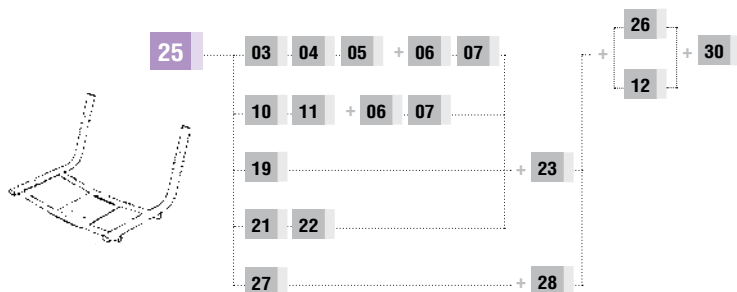

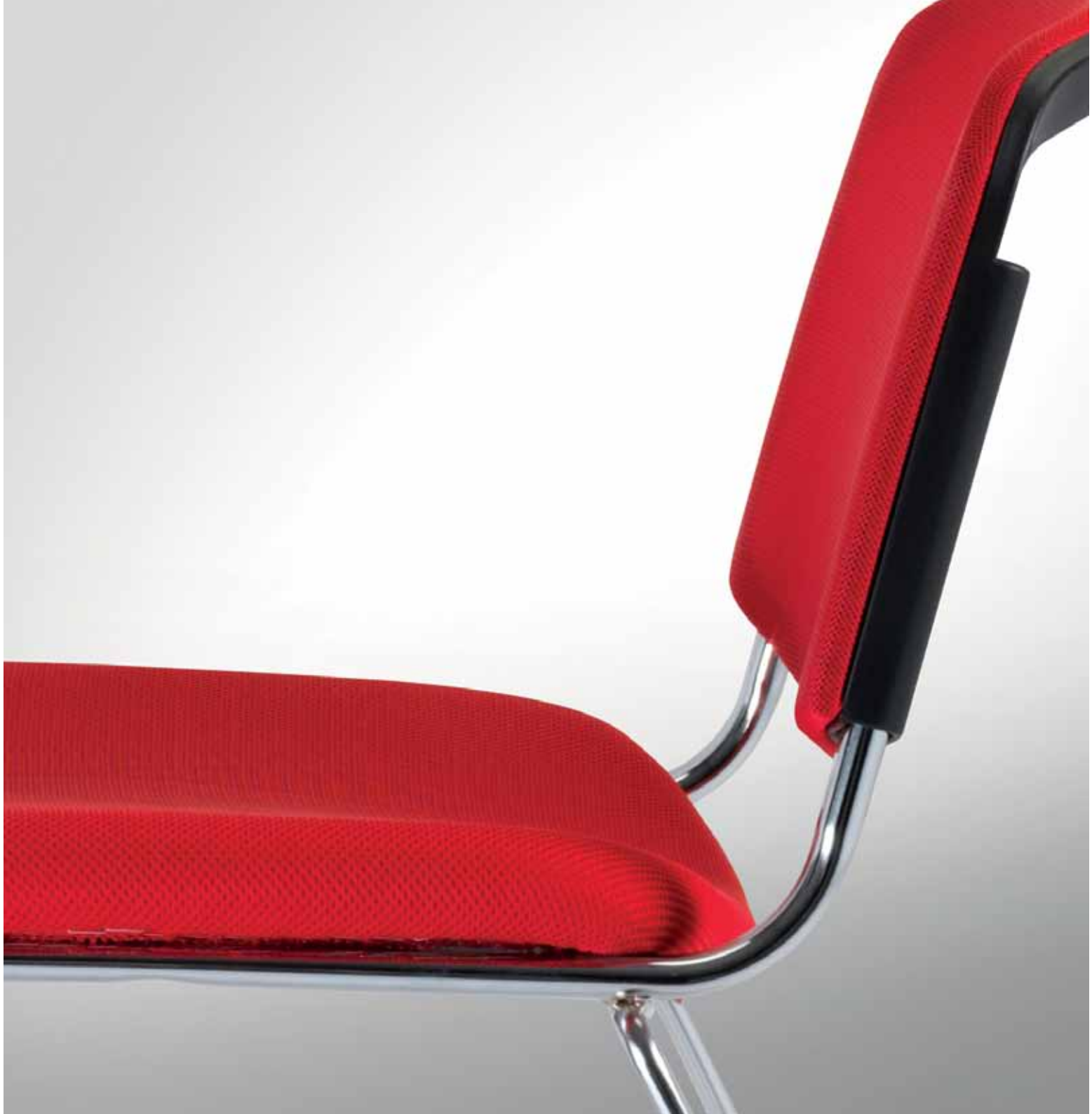





MICHIGAN

SLIDE

4 LEGS

4 LEGS FOR CASTORS

SWIVEL

BENCH



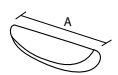
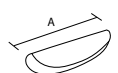
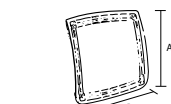
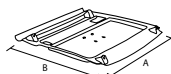
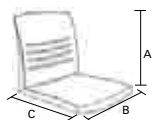
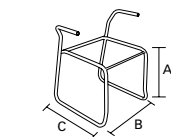

01 + 10 + 12 + 13 + 11 + 18 + 15 + 16 + 23 + 14 + 17

10

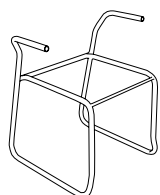

01 TELAIO CHIUSO CON BRACCIOLI TAPPI ESCLUSI

SLED FRAME PIPE D.22 WITH ARMS CAPS EXCLUDED

CODICE/CODE	FINITURA/FINISHING	Q. KIT	Q. MIN/PACK	A	B	C	KG. x1/WT.x1	VOL. x1/UNIT VOL.
111903-063	■ NERO/BLACK	x1	50	450	520	550	4,90	mc. 0,04
111904-063	■ GRIGIO/GREY	x1	50	450	520	550	4,90	mc. 0,04
111910-063	■ CROMATO/CHROME	x1	50	450	520	550	4,90	mc. 0,04

10 MICHIGAN-SCocca INTERA MODELLO MICHIGAN

MICHIGAN-SHELL MODEL MICHIGAN

CODICE/CODE	FINITURA/FINISHING	Q. KIT	Q. MIN/PACK	A	B	C	KG. x1/WT.x1	VOL. x1/UNIT VOL.
133903-030	■ NERO/BLACK	x1	5	430	455	545	3,00	mc. 0,04
133904-030	■ GRIGIO/GREY	x1	5	430	455	545	3,00	mc. 0,04
133915-030	■ BLU/BLUE RAL5002	x1	5	430	455	545	3,00	mc. 0,04

11 MICHIGAN-COPERTINA SOTTOSEDILE IN PLASTICA NERO + VITI

MICHIGAN-OUTER SEAT BLACK WITH SCREW

CODICE/CODE	FINITURA/FINISHING	Q. KIT	Q. MIN/PACK	A	B	KG. x1/WT.x1	VOL. x1/UNIT VOL.
132203-057	■ NERO/BLACK	x1	20	450	480	0,85	0,007

12 MICHIGAN-PANNELLO SCHIENALE DA TAPPEZZARE + VITI

MICHIGAN-PANEL BACK FOR UPHOLSTERY WITH SCREWS

CODICE/CODE	FINITURA/FINISHING	Q. KIT	Q. MIN/PACK	A	B	KG. x1/WT.x1	VOL. x1/UNIT VOL.
132103-012	■ NERO/BLACK	x1	20	370	400	0,53	0,003

13 MICHIGAN-PANNELLO SEDILE DA TAPPEZZARE

MICHIGAN-PANEL SEAT FOR UPHOLSTERY

CODICE/CODE	FINITURA/FINISHING	Q. KIT	Q. MIN/PACK	A	B	KG. x1/WT.x1	VOL. x1/UNIT VOL.
132203-056	■ NERO/BLACK	x1	20	400	430	0,60	0,004

14 VITE HILO TSP+ D.4X16 BRUNITA NERA (VITE PER FISSAGGIO PANNELLO SEDILE)

SCREW AUTO-THREAD TSP+ D.4X16 BURNISHING BLACK (SCREW FOR FIXING SEAT PANEL)

CODICE/CODE	FINITURA/FINISHING	Q. KIT
117803-128	■ NERO/BLACK	x8

15 MICHIGAN-BRACCIOLO IN PLASTICA MODELLO NOTA (SINISTRO)

MICHIGAN-ARMREST PLASTIC MODEL NOTA (LEFT)

CODICE/CODE	FINITURA/FINISHING	Q. KIT	Q. MIN/PACK	A	KG. x1/WT.x1	VOL. x1/UNIT VOL.
131703-061	■ NERO/BLACK	x1	100	220	0,10	0,0001
131704-061	■ GRIGIO/GREY	x1	100	220	0,10	0,0001
131715-061	■ BLU/BLUE RAL5002	x1	100	220	0,10	0,0001

16 MICHIGAN-BRACCIOLO IN PLASTICA MODELLO NOTA (DESTRO)

MICHIGAN-ARMREST PLASTIC MODEL NOTA (RIGHT)

CODICE/CODE	FINITURA/FINISHING	Q. KIT	Q. MIN/PACK	A	KG. x1/WT.x1	VOL. x1/UNIT VOL.
131703-060	■ NERO/BLACK	x1	100	220	0,10	0,0001
131704-060	■ GRIGIO/GREY	x1	100	220	0,10	0,0001
131715-060	■ BLU/BLUE RAL5002	x1	100	220	0,10	0,0001

18 MICHIGAN-COPPIA LISTE/AGGANCI IN PLASTICA NERO

MICHIGAN-PAIR OF LISTS/HOOKS BLACK PLASTIC

CODICE/CODE	FINITURA/FINISHING	Q. KIT	Q. MIN/PACK	KG. x1/WT.x1	VOL. x1/UNIT VOL.
134003-135	■ NERO/BLACK	x1	50	0,25	0,0003

17 VITE HILO TSP+ D.4X16 BRUNITA NERA (VITE PER FISSAGGIO BRACCIOLI)

SCREW AUTO-THREAD TSP+ D.4X16 BURNISHING BLACK (SCREW FOR FIXING ARMRESTS)

CODICE/CODE	FINITURA/FINISHING	Q. KIT
117803-128	■ NERO/BLACK	x4

23 P2P PINZA DUE PIOLI POLITENE NERA

P2P TWO-PINS PLIER IN BLACK POLYTHENE

CODICE/CODE	FINITURA/FINISHING	Q. KIT
134003-003	■ NERO/BLACK	x4

SLIDE OPTIONS:

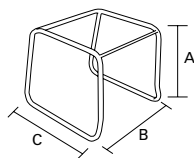
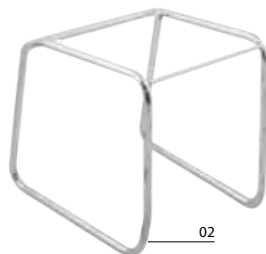

02 TELAIO CHIUSO SENZA BRACCIOLI TAPPI ESCLUSI									
SLED FRAME PIPE D.22 WITHOUT ARMS CAPS EXCLUDED									
CODICE/CODE	FINITURA/FINISHING	Q.KIT	Q.MIN/PACK	A	B	C	KG.x1/WT.x1	VOL.x1/UNIT VOL.	
111903-062	■ NERO/BLACK	x1	100	450	520	550	4,00	mc. 0,03	
111904-062	■ GRIGIO/GREY	x1	100	450	520	550	4,00	mc. 0,03	
111910-062	■ CROMATO/CHROME	x1	100	450	520	550	4,00	mc. 0,03	



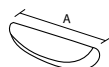
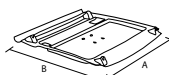
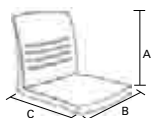
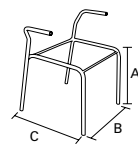

180 MICHIGAN

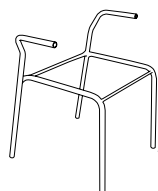

03 TELAIO QUATTRO GAMBE CON BRACCIOLI

FRAME WITH FOUR LEGS WITH ARMS

CODICE/CODE	FINITURA/FINISHING	Q. KIT	Q. MIN/PACK	A	B	C	KG. x1/WT.x1	VOL. x1/UNIT VOL.
111903-061	■ NERO/BLACK	x1	50	450	520	550	4,00	mc. 0,03
111904-061	■ GRIGIO/GREY	x1	50	450	520	550	4,00	mc. 0,03
111910-061	■ CROMATO/CHROME	x1	50	450	520	550	4,00	mc. 0,03

07 TAPPO Ø22 TESTA SFERICA

CAP Ø22 SPHERICAL HEAD

CODICE/CODE	FINITURA/FINISHING	Q. KIT
134203-224	■ NERO/BLACK	x4

10 MICHIGAN-SCOCCA INTERA MODELLO MICHIGAN

MICHIGAN-SHELL MODEL MICHIGAN

CODICE/CODE	FINITURA/FINISHING	Q. KIT	Q. MIN/PACK	A	B	C	KG. x1/WT.x1	VOL. x1/UNIT VOL.
133903-030	■ NERO/BLACK	x1	5	430	455	545	3,00	mc. 0,04
133904-030	■ GRIGIO/GREY	x1	5	430	455	545	3,00	mc. 0,04
133915-030	■ BLU/BLUE RAL5002	x1	5	430	455	545	3,00	mc. 0,04

11 MICHIGAN-COPERTINA SOTTOSEDLILE IN PLASTICA NERO + VITI

MICHIGAN-OUTER SEAT BLACK WITH SCREW

CODICE/CODE	FINITURA/FINISHING	Q. KIT	Q. MIN/PACK	A	B	KG. x1/WT.x1	VOL. x1/UNIT VOL.
132203-057	■ NERO/BLACK	x1	20	450	480	0,85	0,007

12 MICHIGAN-PANNELLO SCHIENALE DA TAPPEZZARE + VITI

MICHIGAN-PANEL BACK FOR UPHOLSTERY WITH SCREWS

CODICE/CODE	FINITURA/FINISHING	Q. KIT	Q. MIN/PACK	A	B	KG. x1/WT.x1	VOL. x1/UNIT VOL.
132103-012	■ NERO/BLACK	x1	20	370	400	0,53	0,003

13 MICHIGAN-PANNELLO SEDILE DA TAPPEZZARE

MICHIGAN-PANEL SEAT FOR UPHOLSTERY

CODICE/CODE	FINITURA/FINISHING	Q. KIT	Q. MIN/PACK	A	B	KG. x1/WT.x1	VOL. x1/UNIT VOL.
132203-056	■ NERO/BLACK	x1	20	400	430	0,60	0,004

14 VITE HILO TSP+ D.4X16 BRUNITA NERA (VITE PER FISSAGGIO PANNELLO SEDILE)

SCREW AUTO-THREAD TSP+ D.4X16 BURNISHING BLACK (SCREW FOR FIXING SEAT PANEL)

CODICE/CODE	FINITURA/FINISHING	Q. KIT
117803-128	■ NERO/BLACK	x8

15 MICHIGAN-BRACCIOLO IN PLASTICA MODELLO NOTA (SINISTRO)

MICHIGAN-ARMREST PLASTIC MODEL NOTA (LEFT)

CODICE/CODE	FINITURA/FINISHING	Q. KIT	Q. MIN/PACK	A	KG. x1/WT.x1	VOL. x1/UNIT VOL.
131703-061	■ NERO/BLACK	x1	100	220	0,10	0,0001
131704-061	■ GRIGIO/GREY	x1	100	220	0,10	0,0001
131715-061	■ BLU/BLUE RAL5002	x1	100	220	0,10	0,0001

16 MICHIGAN-BRACCIOLO IN PLASTICA MODELLO NOTA (DESTRO)

MICHIGAN-ARMREST PLASTIC MODEL NOTA (RIGHT)

CODICE/CODE	FINITURA/FINISHING	Q. KIT	Q. MIN/PACK	A	KG. x1/WT.x1	VOL. x1/UNIT VOL.
131703-060	■ NERO/BLACK	x1	100	220	0,10	0,0001
131704-060	■ GRIGIO/GREY	x1	100	220	0,10	0,0001
131715-060	■ BLU/BLUE RAL5002	x1	100	220	0,10	0,0001

17 VITE HILO TSP+ D.4X16 BRUNITA NERA (VITE PER FISSAGGIO BRACCIOLI)

SCREW AUTO-THREAD TSP+ D.4X16 BURNISHING BLACK (SCREW FOR FIXING ARMRESTS)

CODICE/CODE	FINITURA/FINISHING	Q. KIT
117803-128	■ NERO/BLACK	x4

18 MICHIGAN-COPPIA LISTE/AGGANCI IN PLASTICA NERO

MICHIGAN-PAIR OF LISTS/HOOKS BLACK PLASTIC

CODICE/CODE	FINITURA/FINISHING	Q. KIT	Q. MIN/PACK	KG. x1/WT.x1	VOL. x1/UNIT VOL.
134003-135	■ NERO/BLACK	x1	50	0,25	0,0003

4 LEGS OPTIONS:

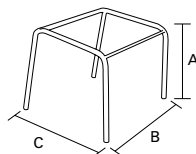
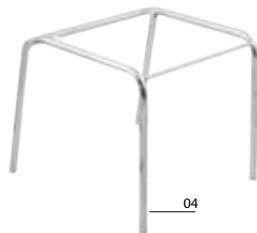

04 TELAIO 4 GAMBE SENZA BRACCIOLI FRAME WITH FOUR LEGS WITHOUT ARMS								
CODICE/CODE	FINITURA/FINISHING	Q. KIT	Q. MIN/PACK	A	B	C	KG. x1/WT.x1	VOL. x1/UNIT VOL.
111903-060	■ NERO/BLACK	x1	100	450	520	550	3,10	mc. 0,02
111904-060	■ GRIGIO/GREY	x1	100	450	520	550	3,10	mc. 0,02
111910-060	■ CROMATO/CHROME	x1	100	450	520	550	3,10	mc. 0,02

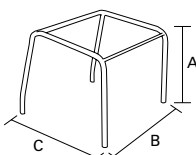
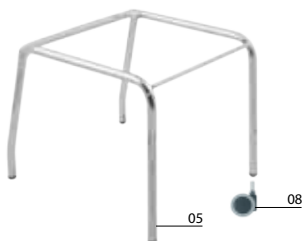

05 TELAIO QUATTRO GAMBE SENZA BRACCIOLI PER RUOTE + 4 RIDUTTORI PER RUOTE FRAME FOUR LEGS WITHOUT ARMS FOR CASTORS +4 ADAPTER FOR CASTORS								
CODICE/CODE	FINITURA/FINISHING	Q. KIT	Q. MIN/PACK	A	B	C	KG. x1/WT.x1	VOL. x1/UNIT VOL.
111903-064	■ NERO/BLACK	x1	100	400	520	550	2,90	mc. 0,02
111904-064	■ GRIGIO/GREY	x1	100	400	520	550	2,90	mc. 0,02
111910-064	■ CROMATO/CHROME	x1	100	400	520	550	2,90	mc. 0,02

08 RUOTA D.50 DESMOPAN CON GAMBO D.11 CASTOR D.50 (DESMOPAN) WITH PIVOT MOUNTED D.11		
CODICE/CODE	FINITURA/FINISHING	Q. KIT
134403-003	■ NERO/BLACK	x4

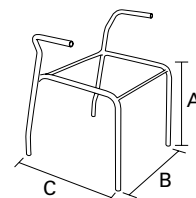
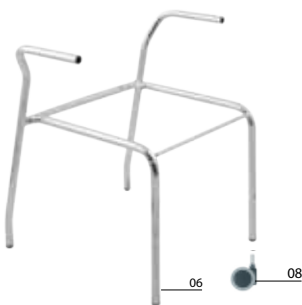

06 TELAIO QUATTRO GAMBE CON BRACCIOLI PER RUOTE + 4 RIDUTTORI PER RUOTE FRAME FOUR LEGS WITH ARMS FOR CASTORS +4 ADAPTER FOR CASTORS								
CODICE/CODE	FINITURA/FINISHING	Q. KIT	Q. MIN/PACK	A	B	C	KG. x1/WT.x1	VOL. x1/UNIT VOL.
111903-065	■ NERO/BLACK	x1	50	400	520	550	3,80	mc. 0,03
111904-065	■ GRIGIO/GREY	x1	50	400	520	550	3,80	mc. 0,03
111910-065	■ CROMATO/CHROME	x1	50	400	520	550	3,80	mc. 0,03

08 RUOTA D.50 DESMOPAN CON GAMBO D.11 CASTOR D.50 (DESMOPAN) WITH PIVOT MOUNTED D.11		
CODICE/CODE	FINITURA/FINISHING	Q. KIT
134403-003	■ NERO/BLACK	x4

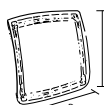
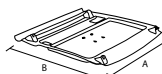
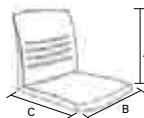
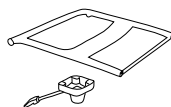

19 MICHIGAN-TELAIO GIREVOLE SENZA BRACCIOLI CON COMANDO A GAS

MICHIGAN-SWIVEL FRAME WITHOUT ARMS WITH GAS LEVER

CODICE/CODE	FINITURA/FINISHING	Q. KIT	Q. MIN/PACK	KG.x1/WT.x1
110903-060	■ NERO/BLACK	x1	100	3,25
110904-060	■ GRIGIO/GREY	x1	100	3,25
110910-060	■ CROMATO/CHROME	x1	100	3,25

10 MICHIGAN-SCocca INTERA MODELLO MICHIGAN

MICHIGAN-SHELL MODEL MICHIGAN

CODICE/CODE	FINITURA/FINISHING	Q. KIT	Q. MIN/PACK	A	B	C	KG.x1/WT.x1	VOL.x1/UNIT VOL.
133903-030	■ NERO/BLACK	x1	5	430	455	545	3,00	mc. 0,04
133904-030	■ GRIGIO/GREY	x1	5	430	455	545	3,00	mc. 0,04
133915-030	■ BLU/BLUE RAL5002	x1	5	430	455	545	3,00	mc. 0,04

11 MICHIGAN-COPERTINA SOTTOSEDILE IN PLASTICA NERO + VITI

MICHIGAN-OUTER SEAT BLACK WITH SCREW

CODICE/CODE	FINITURA/FINISHING	Q. KIT	Q. MIN/PACK	A	B	KG.x1/WT.x1	VOL.x1/UNIT VOL.
132203-057	■ NERO/BLACK	x1	20	450	480	0,85	0,007

12 MICHIGAN-PANNELLO SCHIENALE DA TAPPEZZARE + VITI

MICHIGAN-PANEL BACK FOR UPHOLSTERY WITH SCREWS

CODICE/CODE	FINITURA/FINISHING	Q. KIT	Q. MIN/PACK	A	B	KG.x1/WT.x1	VOL.x1/UNIT VOL.
132103-012	■ NERO/BLACK	x1	20	370	400	0,53	0,003

13 MICHIGAN-PANNELLO SEDILE DA TAPPEZZARE

MICHIGAN-PANEL SEAT FOR UPHOLSTERY

CODICE/CODE	FINITURA/FINISHING	Q. KIT	Q. MIN/PACK	A	B	KG.x1/WT.x1	VOL.x1/UNIT VOL.
132203-056	■ NERO/BLACK	x1	20	400	430	0,60	0,004

14 VITE HILO TSP+ D.4X16 BRUNITA NERA (VITE PER FISSAGGIO PANNELLO SEDILE)

SCREW AUTO-THREAD TSP+ D.4X16 BURNISHING BLACK (SCREW FOR FIXING SEAT PANEL)

CODICE/CODE	FINITURA/FINISHING	Q. KIT
117803-128	■ NERO/BLACK	x8

19 + 10 + 12 + 13 + 11 + 14

10

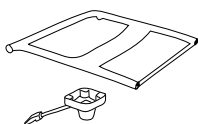

MICHIGAN BENCH



PER I COMPONENTI DELLA PANCA VAI A PAG. 337
FOR THE BENCH COMPONENTS GO TO PAGE 337

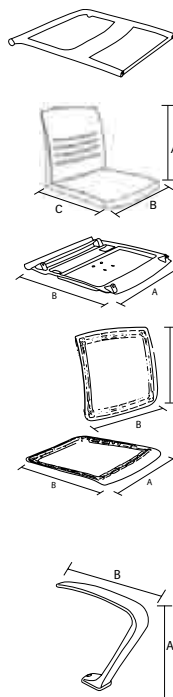

21	MICHIGAN-TELAIO SENZA BRACCIOLI PER ATTACCO SU PANCA MICHIGAN-BENCH FRAME WITHOUT ARMS	Q.KIT	Q.MIN/PACK			KG.x1/WT.x1		
	CODICE/CODE FINITURA/FINISHING							
	110703-037 ■ NERO/BLACK	x1	100			2,90		
	110704-037 ■ GRIGIO/GREY	x1	100			2,90		
110710-037 ■ CROMATO/CHROME	x1	100			2,90			
10	MICHIGAN-SCocca INTERA MODELLO MICHIGAN MICHIGAN-SHELL MODEL MICHIGAN	Q.KIT	Q.MIN/PACK	A	B	C	KG.x1/WT.x1	VOL.x1/UNIT VOL.
	CODICE/CODE FINITURA/FINISHING							
	133903-030 ■ NERO/BLACK	x1	5	430	455	545	3,00	mc. 0,04
	133904-030 ■ GRIGIO/GREY	x1	5	430	455	545	3,00	mc. 0,04
133915-030 ■ BLU/BLUE RAL5002	x1	5	430	455	545	3,00	mc. 0,04	
11	MICHIGAN-COPERTINA SOTTOSEDILE IN PLASTICA NERO + VITI MICHIGAN-OUTER SEAT BLACK WITH SCREW	Q.KIT	Q.MIN/PACK	A	B			
	CODICE/CODE FINITURA/FINISHING					KG.x1/WT.x1	VOL.x1/UNIT VOL.	
132203-057 ■ NERO/BLACK	x1	20	450	480		0,85	0,007	
12	MICHIGAN-PANNELLO SCHIENALE DA TAPPEZZARE + VITI MICHIGAN-PANEL BACK FOR UPHOLSTERY WITH SCREWS	Q.KIT	Q.MIN/PACK	A	B			
	CODICE/CODE FINITURA/FINISHING					KG.x1/WT.x1	VOL.x1/UNIT VOL.	
132103-012 ■ NERO/BLACK	x1	20	370	400		0,53	0,003	
13	MICHIGAN-PANNELLO SEDILE DA TAPPEZZARE MICHIGAN-PANEL SEAT FOR UPHOLSTERY	Q.KIT	Q.MIN/PACK	A	B			
	CODICE/CODE FINITURA/FINISHING					KG.x1/WT.x1	VOL.x1/UNIT VOL.	
132203-056 ■ NERO/BLACK	x1	20	400	430		0,60	0,004	
14	VITE HILO TSP+ D.4X16 BRUNITA NERA (VITE PER FISSAGGIO PANNELLO SEDILE) SCREW AUTO-THREAD TSP+ D.4X16 BURNISHING BLACK (SCREW FOR FIXING SEAT PANEL)	Q.KIT						
	CODICE/CODE FINITURA/FINISHING							
117803-128 ■ NERO/BLACK	x8							
22	SITON-BRACCIOLO IN ALLUMINIO PER PANCA SITON-ALUMINIUM ARM FOR BENCH	Q.KIT	Q.MIN/PACK	A	B			
	CODICE/CODE FINITURA/FINISHING					KG.x1/WT.x1	VOL.x1/UNIT VOL.	
111704-030 ■ ALLUMINIO/ALUMINIUM	x1	10	280	303		1,30	0,0011	

21 + 10 + 12 + 13 + 11 + 14 + 22



10



OPTIONAL GAMBA LEG OPTIONAL



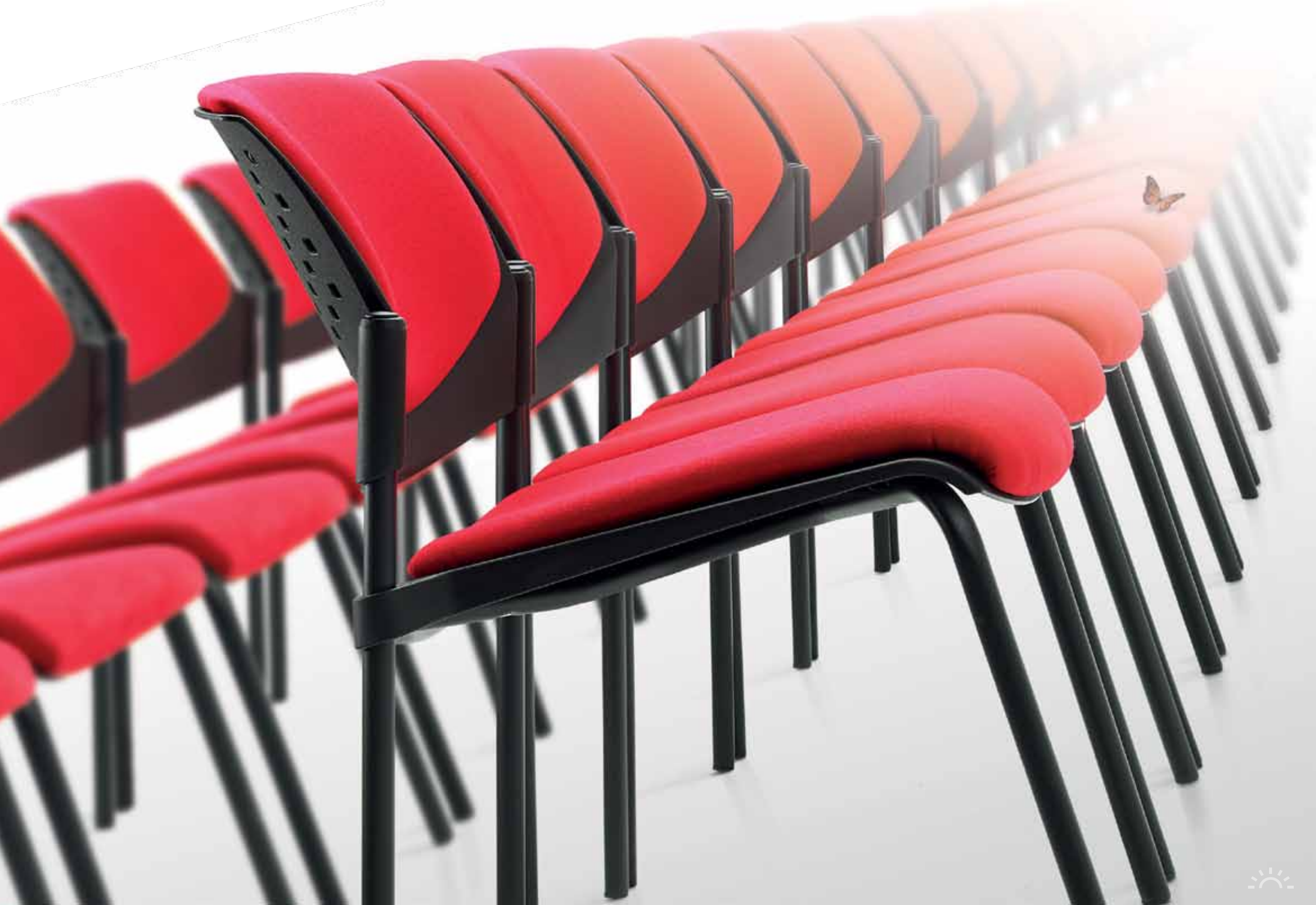



BUTTERFLY

SLIDE

4 LEGS

SWIVEL

BENCH



BUTTERFLY 4 LEGS

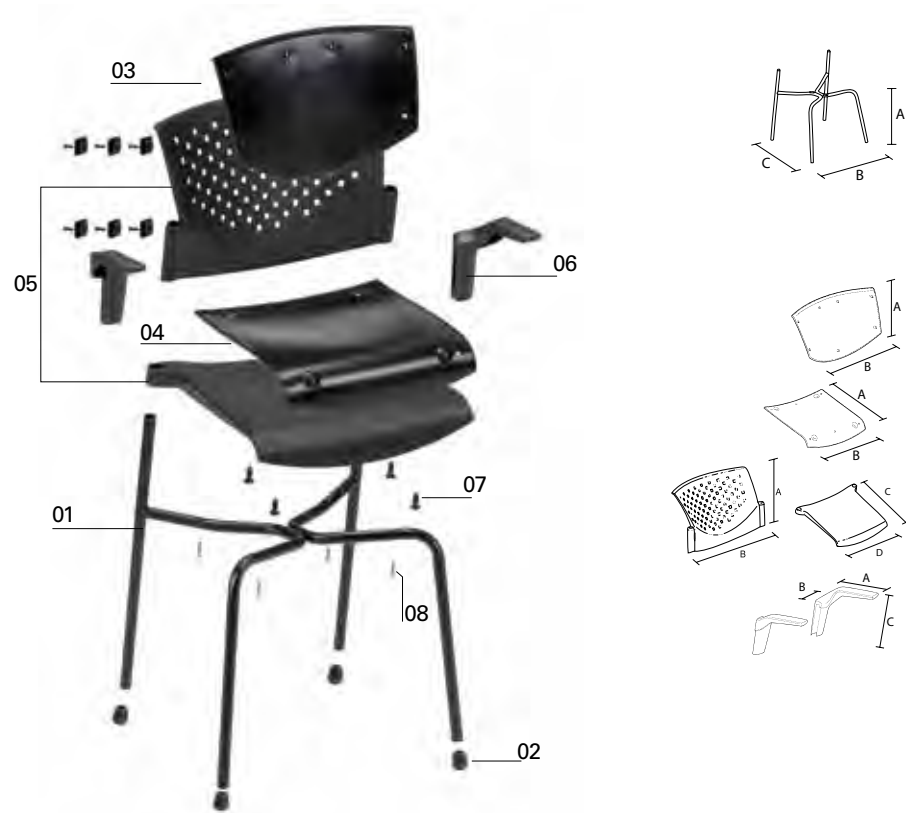

01	BUTTERFLY-TELAIO 4 GAMBE FISSO, TAPPI ESCLUSI BUTTERFLY-FIXED FRAME, CAPS EXCLUDED								
CODICE/CODE	FINITURA/FINISHING	Q. KIT	Q. MIN/PACK	A	B	C	KG. x1/WT.x1	VOL. x1/UNIT VOL.	
112603-020	■ NERO/BLACK	x1	80	450	535	530	2,50	mc. 0,017	
112604-020	■ GRIGIO/GREY	x1	80	450	535	530	2,50	mc. 0,017	
112610-020	■ CROMATO/CHROME	x1	80	450	535	530	2,50	mc. 0,017	
02	TAPPO Ø22 TESTA SFERICA CAP Ø22 SPHERICAL HEAD								
CODICE/CODE	FINITURA/FINISHING	Q. KIT							
134203-224	■ NERO/BLACK	x4							
134204-220	■ GRIGIO/GREY RAL 9006	x4							
03	BUTTERFLY-PANNELLO SCHIENALE DA TAPPEZZARE + CONFEZIONE BUTTERFLY-BACK PANEL FOR UPHOLSTERY + ACCESSORIES								
CODICE/CODE	FINITURA/FINISHING	Q. KIT	Q. MIN/PACK	A	B		KG. x1/WT.x1	VOL. x1/UNIT VOL.	
132103-036	■ NERO/BLACK	x1	20	270	430		0,50	mc. 0,004	
04	BUTTERFLY-PANNELLO SEDILE DA TAPPEZZARE BUTTERFLY-PANEL SEAT FOR UPHOLSTERY								
CODICE/CODE	FINITURA/FINISHING	Q. KIT	Q. MIN/PACK	A	B		KG. x1/WT.x1	VOL. x1/UNIT VOL.	
132203-016	■ NERO/BLACK	x1	20	423	368		0,60	mc. 0,004	
05	BUTTERFLY-COPPIA SEDILE SCHIENALE IN PLASTICA COLORATO BUTTERFLY-PLASTIC SEAT/BACK COLOURED AT SIGHT								
CODICE/CODE	FINITURA/FINISHING	Q. KIT	Q. MIN/PACK	A	B	C	D	KG. x1/WT.x1	VOL. x1/UNIT VOL.
134003-035	■ NERO/BLACK	x1	10	323	495	442	512	1,44	mc. 0,02
06	BUTTERFLY-BRACCIOLO SINISTRO E DESTRO BUTTERFLY-LEFT AND RIGHT ARM								
CODICE/CODE	FINITURA/FINISHING	Q. KIT	Q. MIN/PACK	A	B	C		KG. x1/WT.x1	VOL. x1/UNIT VOL.
131703-025	■ NERO/BLACK DESTRO/RIGHT	x1	40	216	82	170		0,14	mc. 0,002
131703-026	■ NERO/BLACK SINISTRO/LEFT	x1	40	216	82	170		0,14	mc. 0,002
07	VITE AUTOFILETTANTE 5X14 PER PANNELLO DA TAPPEZZARE SCREW AUTO-THREAD 5X14 FOR UPHOLSTERY SEAT								
CODICE/CODE	FINITURA/FINISHING	Q. KIT							
117803-156	■ NERO/BLACK	x4							
08	VITE TRUCCIOLARE TSP 5X35 PER FISSAGGIO SEDILE SCREW CHIPBOARD 5X35 FOR FIXINF SEAT								
CODICE/CODE	FINITURA/FINISHING	Q. KIT							
117811-153	■ ZINCATA/ZINC	x4							



BUTTERFLY SLIDE

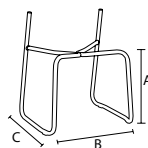
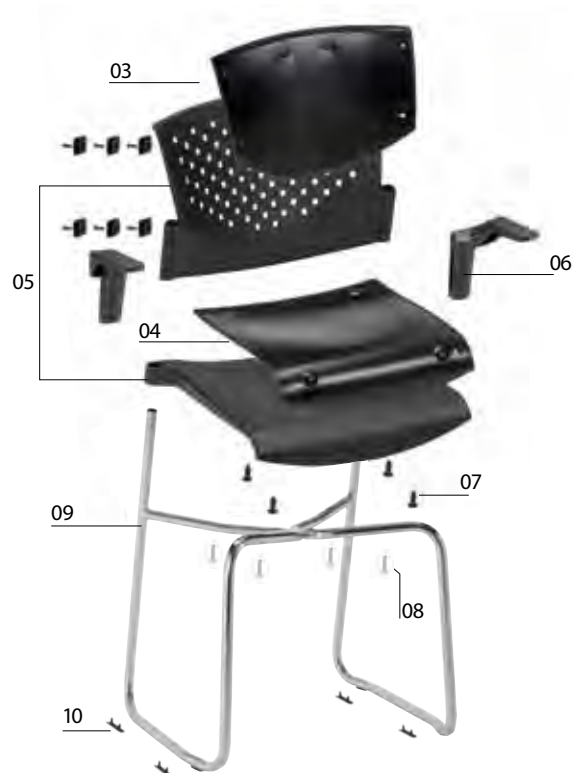

09 BUTTERFLY-TELAIO CHIUSO IN TUBO D.22 TAPPI ESCLUSI

BUTTERFLY-CLOSED FRAME PIPE D.22 CAPS EXCLUDED

CODICE/CODE	FINITURA/FINISHING	Q. KIT	Q. MIN/PACK	A	B	C	KG. x1/WT.x1	VOL. x1/UNIT VOL.
112603-021	■ NERO/BLACK	x1	40	450	550	510	3,30	mc. 0,055
112604-021	■ GRIGIO/GREY	x1	40	450	550	510	3,30	mc. 0,055
112610-023	■ CROMATO/CHROME	x1	40	450	550	510	3,30	mc. 0,055

10 P2P PINZA DUE PIOLI IN POLITENE NERA

P2P TWO PINS PLIERS IN BLACK POLYTHENE

CODICE/CODE	FINITURA/FINISHING	Q. KIT
134003-003	■ NERO/BLACK	x4

09 + 03 + 04 + 05 + 07 + 06 + 08 + 10

05

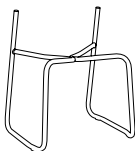

BUTTERFLY SWIVEL

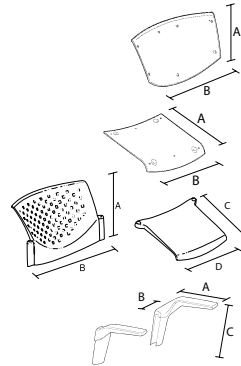
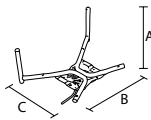

11	BUTTERFLY-TELAIO GIREVOLE CON PIASTRA COMANDO A GAS BUTTERFLY-SWIVEL METAL FRAME WITH GAS PLATE									
CODICE/CODE	FINITURA/FINISHING	Q. KIT	Q. MIN/PACK	A	B	C	KG. x1/WT.x1	VOL. x1/UNIT VOL.		
112603-200	■ NERO/BLACK	x1	80	495	395	355	2,30	mc. 0,046		
112604-200	■ GRIGIO/GREY	x1	80	495	395	355	2,30	mc. 0,046		
02	TAPPO Ø22 TESTA SFERICA CAP Ø22 SPHERICAL HEAD									
CODICE/CODE	FINITURA/FINISHING	Q. KIT								
134203-224	■ NERO/BLACK	x4								
134204-220	■ GRIGIO/GREY RAL 9006	x4								
03	BUTTERFLY-PANNELLO SCHIENALE DA TAPPEZZARE + CONFEZIONE BUTTERFLY-BACK PANEL FOR UPHOLSTERY + ACCESSORIES									
CODICE/CODE	FINITURA/FINISHING	Q. KIT	Q. MIN/PACK	A	B		KG. x1/WT.x1	VOL. x1/UNIT VOL.		
132103-036	■ NERO/BLACK	x1	20	270	430		0,50	mc. 0,004		
04	BUTTERFLY-PANNELLO SEDILE DA TAPPEZZARE BUTTERFLY-PANEL SEAT FOR UPHOLSTERY									
CODICE/CODE	FINITURA/FINISHING	Q. KIT	Q. MIN/PACK	A	B		KG. x1/WT.x1	VOL. x1/UNIT VOL.		
132203-016	■ NERO/BLACK	x1	20	423	368		0,60	mc. 0,004		
05	BUTTERFLY-COPPIA SEDILE SCHIENALE IN PLASTICA COLORATO BUTTERFLY-PLASTIC SEAT/BACK COLOURED AT SIGHT									
CODICE/CODE	FINITURA/FINISHING	Q. KIT	Q. MIN/PACK	A	B	C	D	KG. x1/WT.x1	VOL. x1/UNIT VOL.	
134003-035	■ NERO/BLACK	x1	10	323	495	442	512	1,44	mc. 0,02	
06	BUTTERFLY-BRACCIOLO SINISTRO E DESTRO BUTTERFLY-LEFT AND RIGHT ARM									
CODICE/CODE	FINITURA/FINISHING	Q. KIT	Q. MIN/PACK	A	B	C		KG. x1/WT.x1	VOL. x1/UNIT VOL.	
131703-025	■ NERO/BLACK DESTRO/RIGHT	x1	40	216	82	170		0,14	mc. 0,002	
131703-026	■ NERO/BLACK SINISTRO/LEFT	x1	40	216	82	170		0,14	mc. 0,002	
07	VITE AUTOFILETTANTE 5X14 PER PANNELLO DA TAPPEZZARE SCREW AUTO-THREAD 5X14 FOR UPHOLSTERY SEAT									
CODICE/CODE	FINITURA/FINISHING	Q. KIT								
117803-156	■ NERO/BLACK	x4								
08	VITE TRUCCIOLO TSP 5X35 PER FISSAGGIO SEDILE SCREW CHIPBOARD 5X35 FOR FIXINF SEAT									
CODICE/CODE	FINITURA/FINISHING	Q. KIT								
117811-153	■ ZINCATA/ZINC	x4								

11 + 03 + 04 + 05 + 07 + 06 + 08 + 02

05

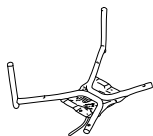

4 LEGS OPTIONS:

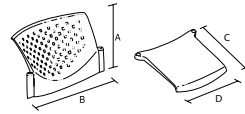

05 BUTTERFLY-COPPIA SEDILE SCHIENALE IN PLASTICA COLORATO		BUTTERFLY-PLASTIC SEAT/BACK COLOURED AT SIGHT							
CODICE/CODE	FINITURA/FINISHING	Q. KIT	Q. MIN/PACK	A	B	C	D	KG. x1/WT.x1	VOL. x1/UNIT VOL.
134003-035	■ NERO/BLACK	x1	10	323	495	442	512	1,44	mc. 0,02

+ 08 VITE / SCREW

SLIDE OPTIONS:

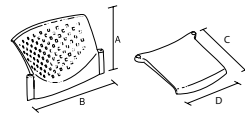

05 BUTTERFLY-COPPIA SEDILE SCHIENALE IN PLASTICA COLORATO		BUTTERFLY-PLASTIC SEAT/BACK COLOURED AT SIGHT							
CODICE/CODE	FINITURA/FINISHING	Q. KIT	Q. MIN/PACK	A	B	C	D	KG. x1/WT.x1	VOL. x1/UNIT VOL.
134003-035	■ NERO/BLACK	x1	10	323	495	442	512	1,44	mc. 0,02

+ 08 VITE / SCREW

SWIVEL OPTIONS:

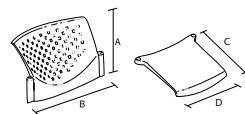

05 BUTTERFLY-COPPIA SEDILE SCHIENALE IN PLASTICA COLORATO		BUTTERFLY-PLASTIC SEAT/BACK COLOURED AT SIGHT							
CODICE/CODE	FINITURA/FINISHING	Q. KIT	Q. MIN/PACK	A	B	C	D	KG. x1/WT.x1	VOL. x1/UNIT VOL.
134003-035	■ NERO/BLACK	x1	10	323	495	442	512	1,44	mc. 0,02

+ 08 VITE / SCREW



PER I COMPONENTI DELLA PANCA VAI A PAG. 337
FOR THE BENCH COMPONENTS GO TO PAGE 337

BUTTERFLY

12	BUTTERFLY-TELAIO PER PANCA TAPPI ESCLUSI BUTTERFLY-BENCH FRAME CAPS EXCLUDED								
CODICE/CODE	FINITURA/FINISHING	Q. KIT	Q. MIN/PACK	A	B	C	KG. x1/WT.x1	VOL. x1/UNIT VOL.	
110703-045	■ NERO/BLACK	x1	80	495	395	355	2,10	mc. 0,046	
110704-060	■ GRIGIO/GREY	x1	80	495	395	355	2,10	mc. 0,046	
02	TAPPO Ø22 TESTA SFERICA CAP Ø22 SPHERICAL HEAD								
CODICE/CODE	FINITURA/FINISHING	Q. KIT							
134203-224	■ NERO/BLACK	x4							
134204-220	■ GRIGIO/GREY RAL 9006	x4							
03	BUTTERFLY-PANNELLO SCHIENALE DA TAPPEZZARE + CONFEZIONE BUTTERFLY-BACK PANEL FOR UPHOLSTERY + ACCESSORIES								
CODICE/CODE	FINITURA/FINISHING	Q. KIT	Q. MIN/PACK	A	B		KG. x1/WT.x1	VOL. x1/UNIT VOL.	
132103-036	■ NERO/BLACK	x1	20	270	430		0,50	mc. 0,004	
04	BUTTERFLY-PANNELLO SEDILE DA TAPPEZZARE BUTTERFLY-PANEL SEAT FOR UPHOLSTERY								
CODICE/CODE	FINITURA/FINISHING	Q. KIT	Q. MIN/PACK	A	B		KG. x1/WT.x1	VOL. x1/UNIT VOL.	
132203-016	■ NERO/BLACK	x1	20	423	368		0,60	mc. 0,004	
05	BUTTERFLY-COPPIA SEDILE SCHIENALE IN PLASTICA COLORATO BUTTERFLY-PLASTIC SEAT/BACK COLOURED AT SIGHT								
CODICE/CODE	FINITURA/FINISHING	Q. KIT	Q. MIN/PACK	A	B	C	D	KG. x1/WT.x1	VOL. x1/UNIT VOL.
134003-035	■ NERO/BLACK	x1	10	323	495	442	512	1,44	mc. 0,02
06	BUTTERFLY-BRACCIOLO SINISTRO E DESTRO BUTTERFLY-LEFT AND RIGHT ARM								
CODICE/CODE	FINITURA/FINISHING	Q. KIT	Q. MIN/PACK	A	B	C		KG. x1/WT.x1	VOL. x1/UNIT VOL.
131703-025	■ NERO/BLACK DESTRO/RIGHT	x1	40	216	82	170		0,14	mc. 0,002
131703-026	■ NERO/BLACK SINISTRO/LEFT	x1	40	216	82	170		0,14	mc. 0,002
07	VITE AUTOFILETTANTE 5X14 PER PANNELLO DA TAPPEZZARE SCREW AUTO-THREAD 5X14 FOR UPHOLSTERY SEAT								
CODICE/CODE	FINITURA/FINISHING	Q. KIT							
117803-156	■ NERO/BLACK	x4							
08	VITE TRUCCIOLARE TSP 5X35 PER FISSAGGIO SEDILE SCREW CHIPBOARD 5X35 FOR FIXING SEAT								
CODICE/CODE	FINITURA/FINISHING	Q. KIT							
117811-153	■ ZINCATA/ZINC	x4							

12 + 03 + 04 + 05 + 07 + 06 + 08 + 02

05

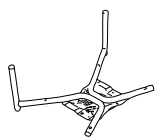

OPTIONAL GAMBA
LEG OPTIONAL



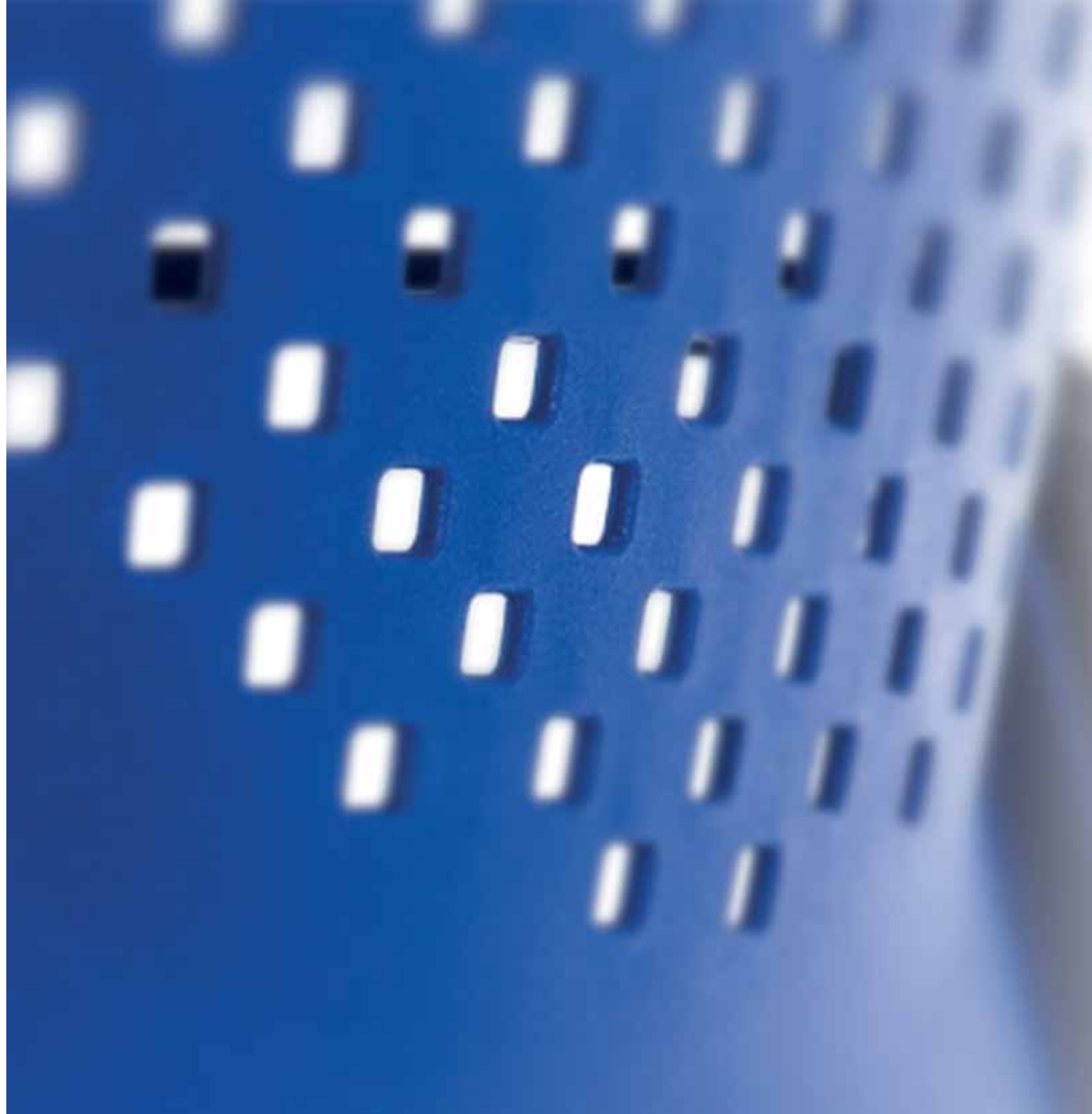





SLIDE



4 LEGS



BENCH

BELLA



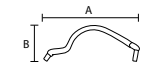
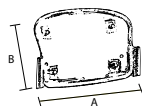
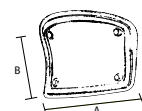
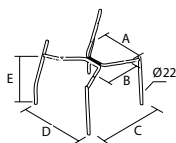

01 BELLA-TELAIO FISSO PER SEDIA TAPPI ESCLUSI
BELLA-FIXED METAL FRAME FOR CHAIR CAPS EXCLUDED

CODICE/CODE	FINITURA/FINISHING	Q. KIT	Q. MIN/PACK	A	B	C	D	E	KG. x1/WT.x1	VOL. x1/UNIT VOL.
111803-020	■ NERO/BLACK	x1	80	265	285	485	530	450	2,80	mc. 0,035
111804-010	■ GRIGIO/GREY	x1	80	265	285	485	530	450	2,80	mc. 0,035
111810-001	■ CROMATO/CHROME	x1	80	265	285	485	530	450	2,80	mc. 0,035

02 TAPPO Ø22 TESTA SFERICA
CAP Ø22 SPHERICAL HEAD

CODICE/CODE	FINITURA/FINISHING	Q. KIT
134203-224	■ NERO/BLACK	x4
134204-220	■ GRIGIO/GREY RAL 9006	x4

03 BELLA SHI-SCHIENALE INTERNO PLASTICA
BELLA-SHI-INNER PLASTIC BACK

CODICE/CODE	FINITURA/FINISHING	Q. KIT	Q. MIN/PACK	A	B	KG. x1/WT.x1	VOL. x1/UNIT VOL.
132103-024	■ NERO/BLACK	x1	20	450	340	0,42	mc. 0,008

04 BELLA SHE-SCHIENALE ESTERNO PLASTICA
BELLA-SHE-EXTERNAL PLASTIC BACK

CODICE/CODE	FINITURA/FINISHING	Q. KIT	Q. MIN/PACK	A	B	KG. x1/WT.x1	VOL. x1/UNIT VOL.
132103-023	■ NERO/BLACK	x1	20	510	350	0,63	mc. 0,01
132104-023	■ GRIGIO/GREY RAL 7040	x1	20	510	350	0,63	mc. 0,01

05 BELLA SDI-SEDILE INTERNO PLASTICA
BELLA-SDI-INNER PLASTIC SEAT

CODICE/CODE	FINITURA/FINISHING	Q. KIT	Q. MIN/PACK	A	B	KG. x1/WT.x1	VOL. x1/UNIT VOL.
132203-024	■ NERO/BLACK	x1	20	430	450	0,70	mc. 0,008

06 BELLA SDE-SEDILE ESTERNO PLASTICA
BELLA-SDE-EXTERNAL PLASTIC SEAT

CODICE/CODE	FINITURA/FINISHING	Q. KIT	Q. MIN/PACK	A	B	KG. x1/WT.x1	VOL. x1/UNIT VOL.
132203-023	■ NERO/BLACK	x1	20	440	460	0,54	mc. 0,005
132204-023	■ GRIGIO/GREY RAL 7040	x1	20	440	460	0,54	mc. 0,005

07 BELLA-BRACCIOLO SINISTRO E DESTRO
BELLA-LEFT AND RIGHT ARM

CODICE/CODE	FINITURA/FINISHING	Q. KIT	Q. MIN/PACK	A	B	C	KG. x1/WT.x1	VOL. x1/UNIT VOL.
131703-020	■ NERO/BLACK DESTRO/RIGHT	x1	10	410	153	43	0,28	mc. 0,002
131703-021	■ NERO/BLACK SINISTRO/LEFT	x1	10	410	153	43	0,28	mc. 0,002

08 VITE TSP+M6X35 ZINCATA (VITE FISSAGGIO SEDILE)
SCREW TSP M6X35 ZINC (SCREW FOR FIXING UPHOLSTERED SEAT)

CODICE/CODE	FINITURA/FINISHING	Q. KIT
117711-183	■ ZINCATA/ZINC	x4

01 + 03 + 04 + 05 + 06 + 07 + 08 + 02

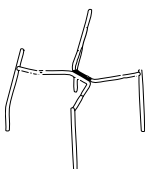

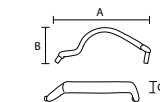
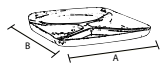
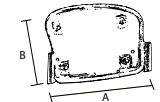
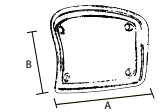
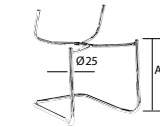

09	BELLA-TELAIO FISSO A SLITTA TAPPI ESCLUSI BELLA-FIXED SLIDE FRAME CAPS EXCLUDED								
CODICE/CODE	FINITURA/FINISHING	Q. KIT	Q. MIN/PACK	A	KG. x1/WT.x1	VOL. x1/UNIT VOL.			
111803-015	■ NERO/BLACK	x1	50	450	4,10	mc. 0,06			
111804-015	■ GRIGIO/GREY	x1	50	450	4,10	mc. 0,06			
111810-015	■ CROMATO/CHROME	x1	50	450	4,10	mc. 0,06			
10	PINZA DUE PIOLI IN POLITILENE NERA TWO PINS PLIER IN BLACK POLYTHENE								
CODICE/CODE	FINITURA/FINISHING	Q. KIT							
134003-003	■ NERO/BLACK	x6							
11	PIEDINO ANTIRIBALTAMENTO IN PLASTICA NERA BLACK PLASTIC ANTI-UPSETTING FEET								
CODICE/CODE	FINITURA/FINISHING	Q. KIT	Q. MIN/PACK		KG. x1/WT.x1	VOL. x1/UNIT VOL.			
134303-006	■ NERO/BLACK	x2	100		0,025	mc. 0,0001			
03	BELLA SHI-SCHIENALE INTERNO PLASTICA BELLA-SHI-INNER PLASTIC BACK								
CODICE/CODE	FINITURA/FINISHING	Q. KIT	Q. MIN/PACK	A	B	KG. x1/WT.x1	VOL. x1/UNIT VOL.		
132103-024	■ NERO/BLACK	x1	20	450	340	0,42	mc. 0,008		
04	BELLA SHE-SCHIENALE ESTERNO PLASTICA BELLA-SHE-EXTERNAL PLASTIC BACK								
CODICE/CODE	FINITURA/FINISHING	Q. KIT	Q. MIN/PACK	A	B	KG. x1/WT.x1	VOL. x1/UNIT VOL.		
132103-023	■ NERO/BLACK	x1	20	510	350	0,63	mc. 0,01		
132104-023	■ GRIGIO/GREY RAL 7040	x1	20	510	350	0,63	mc. 0,01		
05	BELLA SDI-SEDILE INTERNO PLASTICA BELLA-SDI-INNER PLASTIC SEAT								
CODICE/CODE	FINITURA/FINISHING	Q. KIT	Q. MIN/PACK	A	B	KG. x1/WT.x1	VOL. x1/UNIT VOL.		
132203-024	■ NERO/BLACK	x1	20	430	450	0,70	mc. 0,008		
06	BELLA SDE-SEDILE ESTERNO PLASTICA BELLA-SDE-EXTERNAL PLASTIC SEAT								
CODICE/CODE	FINITURA/FINISHING	Q. KIT	Q. MIN/PACK	A	B	KG. x1/WT.x1	VOL. x1/UNIT VOL.		
132203-023	■ NERO/BLACK	x1	20	440	460	0,54	mc. 0,005		
132204-023	■ GRIGIO/GREY RAL 7040	x1	20	440	460	0,54	mc. 0,005		
07	BELLA-BRACCIOLO SINISTRO E DESTRO BELLA-LEFT AND RIGHT ARM								
CODICE/CODE	FINITURA/FINISHING	Q. KIT	Q. MIN/PACK	A	B	C	KG. x1/WT.x1	VOL. x1/UNIT VOL.	
131703-020	■ NERO/BLACK DESTRO/RIGHT	x1	10	410	153	43	0,28	mc. 0,002	
131703-021	■ NERO/BLACK SINISTRO/LEFT	x1	10	410	153	43	0,28	mc. 0,002	
08	VITE TSP-M6X35 ZINCATA (VITE FISSAGGIO SEDILE) SCREW TSP M6X35 ZINC (SCREW FOR FIXING UPHOLSTERED SEAT)								
CODICE/CODE	FINITURA/FINISHING	Q. KIT							
117711-183	■ ZINCATA/ZINC	x4							

09 + 03 + 04 + 05 + 06 + 07 + 08 + 10 + 11

OPTIONAL



OPTIONAL 11
PIEDINO ANTIRIBALTAMENTO
FEET ANTI-UPSETTING



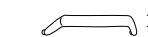
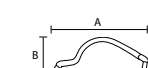
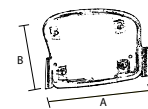
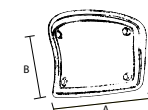
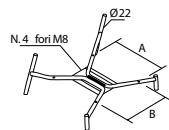

PER I COMPONENTI DELLA PANCA VAI A PAG. 337
FOR THE BENCH COMPONENTS GO TO PAGE 337

12 BELLA-TELAIO PER PANCA TAPPI ESCLUSI BELLA-FRAME FOR BENCH CAPS EXCLUDED										
CODICE/CODE	FINITURA/FINISHING	Q. KIT	Q. MIN/PACK	A	B	C	KG. x1/WT.x1	VOL. x1/UNIT VOL.		
110703-070	■ NERO/BLACK	x1	80	495	396	355	2,10	mc. 0,046		
110704-020	■ GRIGIO/GREY	x1	80	495	396	355	2,10	mc. 0,046		
02 TAPPO Ø22 TESTA SFERICA CAP Ø22 SPHERICAL HEAD										
CODICE/CODE	FINITURA/FINISHING	Q. KIT								
134203-224	■ NERO/BLACK	x4								
134204-220	■ GRIGIO/GREY RAL 9006	x4								
03 BELLA SHI-SCHIENALE INTERNO PLASTICA BELLA-SHI-INNER PLASTIC BACK										
CODICE/CODE	FINITURA/FINISHING	Q. KIT	Q. MIN/PACK	A	B	KG. x1/WT.x1		VOL. x1/UNIT VOL.		
132103-024	■ NERO/BLACK	x1	20	450	340	0,42		mc. 0,008		
04 BELLA SHE-SCHIENALE ESTERNO PLASTICA BELLA-SHE-EXTERNAL PLASTIC BACK										
CODICE/CODE	FINITURA/FINISHING	Q. KIT	Q. MIN/PACK	A	B	KG. x1/WT.x1		VOL. x1/UNIT VOL.		
132103-023	■ NERO/BLACK	x1	20	510	350	0,63		mc. 0,01		
132104-023	■ GRIGIO/GREY RAL 7040	x1	20	510	350	0,63		mc. 0,01		
05 BELLA SDI-SEDILE INTERNO PLASTICA BELLA-SDI-INNER PLASTIC SEAT										
CODICE/CODE	FINITURA/FINISHING	Q. KIT	Q. MIN/PACK	A	B	KG. x1/WT.x1		VOL. x1/UNIT VOL.		
132203-024	■ NERO/BLACK	x1	20	430	450	0,70		mc. 0,008		
06 BELLA SDE-SEDILE ESTERNO PLASTICA BELLA-SDE-EXTERNAL PLASTIC SEAT										
CODICE/CODE	FINITURA/FINISHING	Q. KIT	Q. MIN/PACK	A	B	KG. x1/WT.x1		VOL. x1/UNIT VOL.		
132203-023	■ NERO/BLACK	x1	20	440	460	0,54		mc. 0,005		
132204-023	■ GRIGIO/GREY RAL 7040	x1	20	440	460	0,54		mc. 0,005		
07 BELLA-BRACCIOLLO SINISTRO E DESTRO BELLA-LEFT AND RIGHT ARM										
CODICE/CODE	FINITURA/FINISHING	Q. KIT	Q. MIN/PACK	A	B	C	KG. x1/WT.x1		VOL. x1/UNIT VOL.	
131703-020	■ NERO/BLACK DESTRO/RIGHT	x1	10	410	153	43	0,28		mc. 0,002	
131703-021	■ NERO/BLACK SINISTRO/LEFT	x1	10	410	153	43	0,28		mc. 0,002	
08 VITE TSP-M6X35 ZINCATA (VITE FISSAGGIO SEDILE) SCREW TSP M6X35 ZINC (SCREW FOR FIXING UPHOLSTERED SEAT)										
CODICE/CODE	FINITURA/FINISHING	Q. KIT								
117711-183	■ ZINCATA/ZINC	x4								

12 03 04 + 05 06 + 07 + 08 + 02

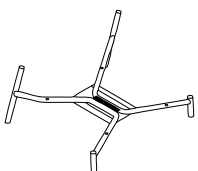

OPTIONAL GAMBA LEG OPTIONAL









AVIATOR

SLIDE

4 LEGS



AVIATOR 4 LEGS

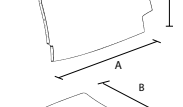
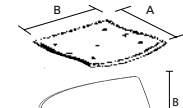
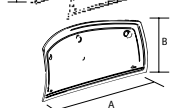
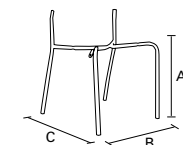

200
AVIATOR

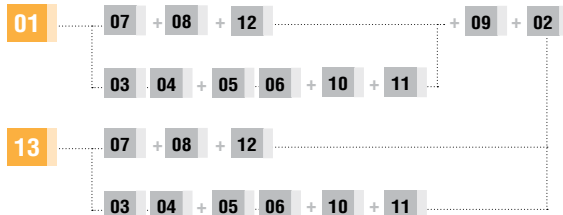

01 AVIATOR-TELAIO PER SEDIA FISSA IN TUBO D. 22 PER BRACCIOLI TAPPI ESCLUSI

AVIATOR-FRAME FOR FIXED CHAIR PIPE D.22 FOR ARMS CAPS EXCLUDED

CODICE/CODE	FINITURA/FINISHING	Q. KIT	Q. MIN/PACK	A	B	C	KG. x1/WT.x1	VOL. x1/UNIT VOL.
112703-022	■ NERO/BLACK	x1	80	450	500	450	2,70	mc. 0,035
112704-022	■ GRIGIO/GREY	x1	80	450	500	450	2,70	mc. 0,035
112710-025	■ CROMATO/CHROME	x1	80	450	500	450	2,70	mc. 0,035

02 TAPPO D.22 TESTA SFERICA

CAP D.22 SPHERICAL HEAD

CODICE/CODE	FINITURA/FINISHING	Q. KIT
134203-224	■ NERO/BLACK	x4
134204-220	■ GRIGIO/GREY	x4

03 AVIATOR SHE-SCHIENALE ESTERNO CON DUE PIASTRINE PLASTICA NERO

AVIATOR-SHE-BLACK PLASTIC EXTERNAL BACK WITH TWO LITTLE PLATES

CODICE/CODE	FINITURA/FINISHING	Q. KIT	Q. MIN/PACK	A	B	KG. x1/WT.x1	VOL. x1/UNIT VOL.
132103-031	■ NERO/BLACK	x1	20	520	240	0,50	mc. 0,005

04 AVIATOR SHI-SCHIENALE INTERNO PLASTICA NERO

AVIATOR-SHI-BLACK PLASTIC INNER BACK

CODICE/CODE	FINITURA/FINISHING	Q. KIT	Q. MIN/PACK	A	B	KG. x1/WT.x1	VOL. x1/UNIT VOL.
132103-030	■ NERO/BLACK	x1	20	520	240	0,31	mc. 0,005

05 AVIATOR SDE-SEDILE ESTERNO PLASTICA NERO

AVIATOR-SDE-BLACK PLASTIC EXTERNAL SEAT

CODICE/CODE	FINITURA/FINISHING	Q. KIT	Q. MIN/PACK	A	B	KG. x1/WT.x1	VOL. x1/UNIT VOL.
132203-042	■ NERO/BLACK	x1	20	462	437	0,62	mc. 0,008

06 AVIATOR SDI-SEDILE INTERNO PLASTICA NERO

AVIATOR-SDI-BLACK PLASTIC INNER SEAT

CODICE/CODE	FINITURA/FINISHING	Q. KIT	Q. MIN/PACK	A	B	KG. x1/WT.x1	VOL. x1/UNIT VOL.
132203-041	■ NERO/BLACK	x1	20	462	437	0,68	mc. 0,008

07 SCHIENALE A VISTA COLORATO CON 2 PIASTRINE

BACK ON SIGHT COLOURED WITH TWO LITTLE PLATES

CODICE/CODE	FINITURA/FINISHING	Q. KIT	Q. MIN/PACK	A	B	KG. x1/WT.x1	VOL. x1/UNIT VOL.
132105-020	■ BEIGE/BEIGE PPL09	x1	20	520	240	0,59	mc. 0,005
132107-021	■ ARANCIO/ORANGE PPL22	x1	20	520	240	0,59	mc. 0,005

08 SEDILE A VISTA COLORATO

SEAT ON SIGHT COLOURED

CODICE/CODE	FINITURA/FINISHING	Q. KIT	Q. MIN/PACK	A	B	KG. x1/WT.x1	VOL. x1/UNIT VOL.
132205-020	■ BEIGE/BEIGE PPL09	x1	20	462	437	0,85	mc. 0,008
132207-021	■ ARANCIO/ORANGE PPL22	x1	20	462	437	0,85	mc. 0,008

09 AVIATOR B-BRACCIOLO DESTRO E SINISTRO NERO

AVIATOR B-LEFT RIGHT BLACK ARM

CODICE/CODE	FINITURA/FINISHING	Q. KIT	Q. MIN/PACK	KG. x1/WT.x1	VOL. x1/UNIT VOL.
131703-015	■ NERO/BLACK DESTRO/RIGHT	x1	10	0,35	mc. 0,003
131703-016	■ NERO/BLACK SINISTRO/LEFT	x1	10	0,35	mc. 0,003

10 VITE AUTOFILETTANTE TSP+D. 3. 5X9.5 ZINCATA (VITE PER FISSAGGIO SCHIENALE)

SCREW AUTO THREADING TSP+D3.5X9.5 ZINC (SCREW FOR FIXING BACK)

CODICE/CODE	FINITURA/FINISHING	Q. KIT
117811-106	■ ZINCATA/ZINC	x2

11 VITE TSP M6X35 ZINCATA (VITE FISSAGGIO SEDILE IMBOTTITO)

SCREW TSP M6X35 ZINC (SCREW FOR FIXING UPHOLSTERED SEAT)

CODICE/CODE	FINITURA/FINISHING	Q. KIT
117711-183	■ ZINCATA/ZINC	x4

12 VITE AUTOFILETTANTE TC+D. 5X19 ZINCATA (VITE FISSAGGIO SEDILE COLORATO A VISTA)

SCREW AUTO THREADING TC+D.5X19 ZINC (SCREW FOR FIXING COLOURED SEAT AT SIGHT)

CODICE/CODE	FINITURA/FINISHING	Q. KIT
117811-180	■ ZINCATA/ZINC	x4

4 LEGS OPTIONS:

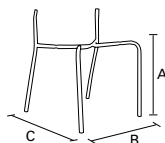

03 AVIATOR-TELAIO PER SEDIA FISSA IN TUBO D.22 TAPPI ESCLUSI AVIATOR-FRAME FOR FIXED CHAIR PIPE D.22 CAPS EXCLUDED									
CODICE/CODE	FINITURA/FINISHING	Q.KIT	Q.MIN/PACK	A	B	C	KG.x1/WT.x1	VOL.x1/UNIT VOL.	
112703-023	■ NERO/BLACK	x1	80	450	500	450	2,70	mc. 0,035	
112704-023	■ GRIGIO/GREY	x1	80	450	500	450	2,70	mc. 0,035	
112710-026	■ CROMATO/CHROME	x1	80	450	500	450	2,70	mc. 0,035	

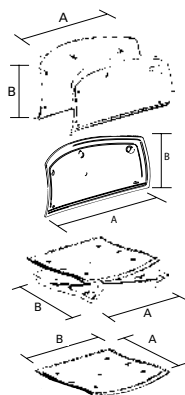

03 AVIATOR SHE-SCHIENALE ESTERNO CON DUE PIASTRINE PLASTICA NERO AVIATOR SHE-BLACK PLASTIC EXTERNAL BACK WITH TWO LITTLE PLATES									
CODICE/CODE	FINITURA/FINISHING	Q.KIT	Q.MIN/PACK	A	B	KG.x1/WT.x1	VOL.x1/UNIT VOL.		
132103-031	■ NERO/BLACK	x1	20	520	240	0,50	mc. 0,005		

04 AVIATOR SHI-SCHIENALE INTERNO PLASTICA NERO AVIATOR SHI-BLACK PLASTIC INNER BACK									
CODICE/CODE	FINITURA/FINISHING	Q.KIT	Q.MIN/PACK	A	B	KG.x1/WT.x1	VOL.x1/UNIT VOL.		
132103-030	■ NERO/BLACK	x1	20	520	240	0,31	mc. 0,005		

05 AVIATOR SDE-SEDILE ESTERNO PLASTICA NERO AVIATOR SDE-BLACK PLASTIC EXTERNAL SEAT									
CODICE/CODE	FINITURA/FINISHING	Q.KIT	Q.MIN/PACK	A	B	KG.x1/WT.x1	VOL.x1/UNIT VOL.		
132203-042	■ NERO/BLACK	x1	20	462	437	0,62	mc. 0,008		

06 AVIATOR SDI-SEDILE INTERNO PLASTICA NERO AVIATOR SDI-BLACK PLASTIC INNER SEAT									
CODICE/CODE	FINITURA/FINISHING	Q.KIT	Q.MIN/PACK	A	B	KG.x1/WT.x1	VOL.x1/UNIT VOL.		
132203-041	■ NERO/BLACK	x1	20	462	437	0,68	mc. 0,008		

+ 10 + 11 VITI / SCREWS

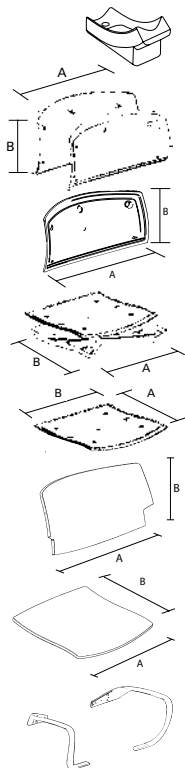
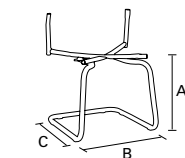

14 07 + 08 + 12 + 09 + 15 + 16
 03 04 + 05 06 + 10 + 11

OPTIONAL



14 AVIATOR-TELAIO FISSO A SLITTA TAPPI ESCLUSI

AVIATOR-FIXED SLIDE FRAME CAPS EXCLUDED

CODICE/CODE	FINITURA/FINISHING	Q. KIT	Q. MIN/PACK	A	B	C	KG.x1/WT.x1	VOL.x1/UNIT VOL.
110503-094	■ NERO/BLACK	x1	50	450	500	450	4,50	mc. 0,06
110504-094	■ GRIGIO/GREY	x1	50	450	500	450	4,50	mc. 0,06
110510-094	■ CROMATO/CHROME	x1	50	450	500	450	4,50	mc. 0,06

15 P2P PINZA DUE PIOLI IN POLITENE NERA

P2P TWO PINS PLIERS IN BLACK POLYTHENE

CODICE/CODE	FINITURA/FINISHING	Q. KIT
134003-003	■ NERO/BLACK	x6

16 PIEDINO ANTIRIBALTAMENTO IN PLASTICA NERA

ANTIUPSETTING BLACK PLASTIC FOOT

CODICE/CODE	FINITURA/FINISHING	Q. KIT	Q. MIN/PACK	KG.x1/WT.x1	VOL.x1/UNIT VOL.
134303-006	■ NERO/BLACK	x2	100	0,025	mc. 0,0001

03 AVIATOR SHE-SCHIENALE ESTERNO CON DUE PIASTRINE PLASTICA NERO

AVIATOR-SHE-BLACK PLASTIC EXTERNAL BACK WITH TWO LITTLE PLATES

CODICE/CODE	FINITURA/FINISHING	Q. KIT	Q. MIN/PACK	A	B	KG.x1/WT.x1	VOL.x1/UNIT VOL.
132103-031	■ NERO/BLACK	x1	20	520	240	0,50	mc. 0,005

04 AVIATOR SHI-SCHIENALE INTERNO PLASTICA NERO

AVIATOR SHI-BLACK PLASTIC INNER BACK

CODICE/CODE	FINITURA/FINISHING	Q. KIT	Q. MIN/PACK	A	B	KG.x1/WT.x1	VOL.x1/UNIT VOL.
132103-030	■ NERO/BLACK	x1	20	520	240	0,31	mc. 0,005

05 AVIATOR SDE-SEDILE ESTERNO PLASTICA NERO

AVIATOR SDE-BLACK PLASTIC EXTERNAL SEAT

CODICE/CODE	FINITURA/FINISHING	Q. KIT	Q. MIN/PACK	A	B	KG.x1/WT.x1	VOL.x1/UNIT VOL.
132203-042	■ NERO/BLACK	x1	20	462	437	0,62	mc. 0,008

06 AVIATOR SDI-SEDILE INTERNO PLASTICA NERO

AVIATOR SDI-BLACK PLASTIC INNER SEAT

CODICE/CODE	FINITURA/FINISHING	Q. KIT	Q. MIN/PACK	A	B	KG.x1/WT.x1	VOL.x1/UNIT VOL.
132203-041	■ NERO/BLACK	x1	20	462	437	0,68	mc. 0,008

07 SCHIENALE A VISTA COLORATO CON 2 PIASTRINE

BACK ON SIGHT COLOURED WITH TWO LITTLE PLATES

CODICE/CODE	FINITURA/FINISHING	Q. KIT	Q. MIN/PACK	A	B	KG.x1/WT.x1	VOL.x1/UNIT VOL.
132105-020	■ BEIGE/BEIGE PPL09	x1	20	520	240	0,59	mc. 0,005
132107-021	■ ARANCIO/ORANGE PPL22	x1	20	520	240	0,59	mc. 0,005

08 SEDILE A VISTA COLORATO

SEAT ON SIGHT COLOURED

CODICE/CODE	FINITURA/FINISHING	Q. KIT	Q. MIN/PACK	A	B	KG.x1/WT.x1	VOL.x1/UNIT VOL.
132205-020	■ BEIGE/BEIGE PPL09	x1	20	462	437	0,85	mc. 0,008
132207-021	■ ARANCIO/ORANGE PPL22	x1	20	462	437	0,85	mc. 0,008

09 AVIATOR B-BRACCIOLO DESTRO E SINISTRO NERO

AVIATOR B-LEFT RIGHT BLACK ARM

CODICE/CODE	FINITURA/FINISHING	Q. KIT	Q. MIN/PACK	KG.x1/WT.x1	VOL.x1/UNIT VOL.
131703-015	■ NERO/BLACK DESTRO/RIGHT	x1	10	0,35	mc. 0,003
131703-016	■ NERO/BLACK SINISTRO/LEFT	x1	10	0,35	mc. 0,003

10 VITE AUTOFILETTANTE TSP+D.3,5X9,5 ZINCATA (VITE PER FISSAGGIO SCHIENALE)

SCREW AUTO THREADING TSP+D3,5X9,5 ZINC (SCREW FOR FIXING BACK)

CODICE/CODE	FINITURA/FINISHING	Q. KIT
117811-106	■ ZINCATA/ZINC	x2

11 VITE TSP M6X35 ZINCATA (VITE FISSAGGIO SEDILE IMBOTTITO)

SCREW TSP M6X35 ZINC (SCREW FOR FIXING UPHOLSTERED SEAT)

CODICE/CODE	FINITURA/FINISHING	Q. KIT
117711-183	■ ZINCATA/ZINC	x4

12 VITE AUTOFILETTANTE TC+D.5X19 ZINCATA (VITE FISSAGGIO SEDILE COLORATO A VISTA)

SCREW AUTO THREADING TC+D.5X19 ZINC (SCREW FOR FIXING COLOURED SEAT AT SIGHT)

CODICE/CODE	FINITURA/FINISHING	Q. KIT
117811-180	■ ZINCATA/ZINC	x4

OPTIONAL 16 PIEDINO ANTIRIBALTAMENTO FEET ANTI-UPSETTING



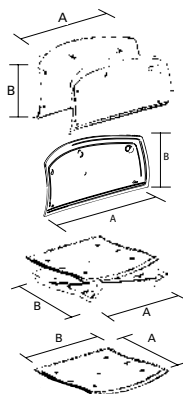

03	AVIATOR SHE-SCHENALE ESTERNO CON DUE PIASTRINE PLASTICA NERO AVIATOR SHE-BLACK PLASTIC EXTERNAL BACK WITH TWO LITTLE PLATES							
CODICE/CODE	FINITURA/FINISHING	Q. KIT	Q. MIN/PACK	A	B	KG. x1/WT.x1	VOL. x1/UNIT VOL.	
132103-031	■ NERO/BLACK	x1	20	520	240	0,50	mc. 0,005	
04	AVIATOR SHI-SCHENALE INTERNO PLASTICA NERO AVIATOR SHI-BLACK PLASTIC INNER BACK							
CODICE/CODE	FINITURA/FINISHING	Q. KIT	Q. MIN/PACK	A	B	KG. x1/WT.x1	VOL. x1/UNIT VOL.	
132103-030	■ NERO/BLACK	x1	20	520	240	0,31	mc. 0,005	
05	AVIATOR SDE-SEDILE ESTERNO PLASTICA NERO AVIATOR SDE-BLACK PLASTIC EXTERNAL SEAT							
CODICE/CODE	FINITURA/FINISHING	Q. KIT	Q. MIN/PACK	A	B	KG. x1/WT.x1	VOL. x1/UNIT VOL.	
132203-042	■ NERO/BLACK	x1	20	462	437	0,62	mc. 0,008	
06	AVIATOR SDI-SEDILE INTERNO PLASTICA NERO AVIATOR SDI-BLACK PLASTIC INNER SEAT							
CODICE/CODE	FINITURA/FINISHING	Q. KIT	Q. MIN/PACK	A	B	KG. x1/WT.x1	VOL. x1/UNIT VOL.	
132203-041	■ NERO/BLACK	x1	20	462	437	0,68	mc. 0,008	

+ 10 + 11 VITI / SCREWS

THE HEAVYWEIGHTS
UFC 146

VELASQUEZ VS BIGFOOT
NELSON VS HERMAN
VELASQUEZ VS BIGFOOT
NELSON VS HERMAN
VELASQUEZ VS BIGFOOT
NELSON VS HERMAN

DOS SANTOS VS MIR
SUNDAY, MAY 27
NSW / VIC / QLD / ACT - 12PM REPLAY 5PM • SA - 11.30AM REPLAY 5.30PM • WA - 10AM REPLAY 4PM

DOS SANTOS VS MIR
SUNDAY, MAY 27
NSW / VIC / QLD / ACT - 12PM REPLAY 5PM • SA - 11.30AM REPLAY 5.30PM • WA - 10AM REPLAY 4PM

WORLD HEAVYWEIGHT CHAMPIONSHIP

FOX SPORTS PLUS • WEIGH-INS • PRELIMS • POST-SHOW LOVE ON FOX SPORTS





4 LEGS



SWIVEL

BENCH



VICTOR

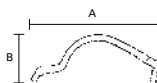
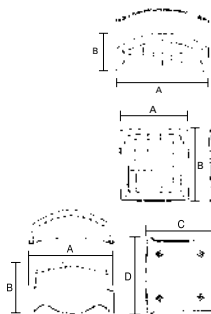
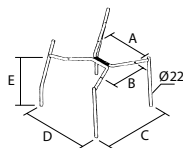

01 VICTOR-TELAIO FISSO PER SEDIA VICTOR-FIXED METAL FRAME FOR CHAIR										
CODICE/CODE	FINITURA/FINISHING	Q. KIT	Q. MIN/PACK	A	B	C	D	E	KG. x1/WT.x1	VOL. x1/UNIT VOL.
111803-020	■ NERO/BLACK	x1	80	265	285	485	530	450	2,80	mc. 0,035
111804-010	■ GRIGIO/GREY	x1	80	265	285	485	530	450	2,80	mc. 0,035
111810-001	■ CROMATO/CHROME	x1	80	265	285	485	530	450	2,80	mc. 0,035

02 TAPPO Ø22 TESTA SFERICA CAP Ø22 SPHERICAL HEAD										
CODICE/CODE	FINITURA/FINISHING	Q. KIT								
134203-224	■ NERO/BLACK	x4								
134204-220	■ GRIGIO/GREY	x4	RAL 9006							

03 VICTOR-PANNELLO SCHIENALE DA TAPPEZZARE VICTOR-PANEL BACK FOR UPHOLSTERY									
CODICE/CODE	FINITURA/FINISHING	Q. KIT	Q. MIN/PACK	A	B			KG. x1/WT.x1	VOL. x1/UNIT VOL.
132103-021	■ NERO/BLACK	x1	20	395	158			0,57	mc. 0,002

04 VICTOR-PANNELLO SEDILE DA TAPPEZZARE VICTOR-PANEL SEAT FOR UPHOLSTERY									
CODICE/CODE	FINITURA/FINISHING	Q. KIT	Q. MIN/PACK	A	B			KG. x1/WT.x1	VOL. x1/UNIT VOL.
132203-021	■ NERO/BLACK	x1	20	395	415			0,396	mc. 0,004

05 VICTOR-COPPIA SEDILE SCHIENALE IN PLASTICA COLORATO VICTOR-PLASTIC SEAT/BACK COLOURED AT SIGHT									
CODICE/CODE	FINITURA/FINISHING	Q. KIT	Q. MIN/PACK	A	B	C	D	KG. x1/WT.x1	VOL. x1/UNIT VOL.
134003-037	■ NERO/BLACK	x1	10	500	322	430	480	1,42	mc. 0,02
134015-037	■ BLU/BLUE	x1	10	500	322	430	480	1,42	mc. 0,02

06 VITE TBL +FR 5X14 PER PANNELLO DA TAPPEZZARE SCREW TBL +FR 5X14 FOR UPHOLSTERY PANEL									
CODICE/CODE	FINITURA/FINISHING	Q. KIT							
117803-156	■ NERO/BLACK	x10							

07 VITE TGS +HILO D.5X35 CEMENTATA PER FISSAGGIO SEDILE SCREW TGS +HILO D.5X35 FOR FIXING SEAT									
CODICE/CODE	FINITURA/FINISHING	Q. KIT							
117811-153	■ ZINCATA/ZINC	x4							

08 VICTOR-BRACCIOLO SINISTRO E DESTRO VICTOR-LEFT AND RIGHT ARM									
CODICE/CODE	FINITURA/FINISHING	Q. KIT	Q. MIN/PACK	A	B			KG. x1/WT.x1	VOL. x1/UNIT VOL.
131703-020	■ NERO/BLACK	x1	10	410	153	DESTRO/RIGHT		0,28	mc. 0,002
131703-021	■ NERO/BLACK	x1	10	410	153	SINISTRO/LEFT		0,28	mc. 0,002

01 + 03 + 04 + 05 + 06 + 07 + 08 + 02

05

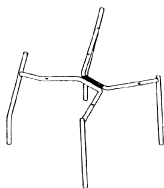

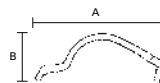
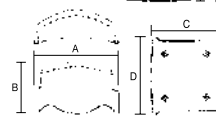
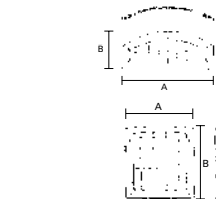
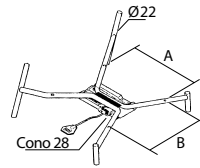

09	VICTOR-TELAIO GIREVOLE CON PIASTRA COMANDO A GAS VICTOR-SWIVEL METAL FRAME WITH PLATE FOR GAS									
CODICE/CODE	FINITURA/FINISHING	Q. KIT	Q. MIN/PACK	A	B	KG. x1/WT.x1	VOL. x1/UNIT VOL.			
111803-200	■ NERO/BLACK	x1	80	265	285	2,50	mc. 0,02			
111804-013	■ GRIGIO/GREY	x1	80	265	285	2,50	mc. 0,02			
111810-010	■ CROMATO/CHROME	x1	80	265	285	2,50	mc. 0,02			
02	TAPPO Ø22 TESTA SFERICA CAP Ø22 SPHERICAL HEAD									
CODICE/CODE	FINITURA/FINISHING	Q. KIT								
134203-224	■ NERO/BLACK	x4								
134204-220	■ GRIGIO/GREY RAL 9006	x4								
03	VICTOR-PANNELLO SCHIENALE DA TAPPEZZARE VICTOR-PANEL BACK FOR UPHOLSTERY									
CODICE/CODE	FINITURA/FINISHING	Q. KIT	Q. MIN/PACK	A	B	KG. x1/WT.x1	VOL. x1/UNIT VOL.			
132103-021	■ NERO/BLACK	x1	20	395	158	0,57	mc. 0,002			
04	VICTOR-PANNELLO SEDILE DA TAPPEZZARE VICTOR-PANEL SEAT FOR UPHOLSTERY									
CODICE/CODE	FINITURA/FINISHING	Q. KIT	Q. MIN/PACK	A	B	KG. x1/WT.x1	VOL. x1/UNIT VOL.			
132203-021	■ NERO/BLACK	x1	20	395	415	0,396	mc. 0,004			
05	VICTOR-COPPIA SEDILE SCHIENALE IN PLASTICA COLORATO VICTOR-PLASTIC SEAT/BACK COLOURED AT SIGHT									
CODICE/CODE	FINITURA/FINISHING	Q. KIT	Q. MIN/PACK	A	B	C	D	KG. x1/WT.x1	VOL. x1/UNIT VOL.	
134003-037	■ NERO/BLACK	x1	10	500	322	430	480	1,42	mc. 0,02	
134015-037	■ BLU/BLEUE RAL 5002	x1	10	500	322	430	480	1,42	mc. 0,02	
06	VITE TBL +FR 5X14 PER PANNELLO DA TAPPEZZARE SCREW TBL +FR 5X14 FOR UPHOLSTERY PANEL									
CODICE/CODE	FINITURA/FINISHING	Q. KIT								
117803-156	■ NERO/BLACK	x10								
07	VITE TGS +HILO D.5X35 CEMENTATA PER FISSAGGIO SEDILE SCREW TGS +HILO D.5x35 FOR FIXING SEAT									
CODICE/CODE	FINITURA/FINISHING	Q. KIT								
117811-153	■ ZINCATA/ZINC	x4								
08	VICTOR-BRACCIOLO SINISTRO E DESTRO VICTOR-LEFT AND RIGHT ARM									
CODICE/CODE	FINITURA/FINISHING	Q. KIT	Q. MIN/PACK	A	B	KG. x1/WT.x1	VOL. x1/UNIT VOL.			
131703-020	■ NERO/BLACK DESTRO/RIGHT	x1	10	410	153	0,28	mc. 0,002			
131703-021	■ NERO/BLACK SINISTRO/LEFT	x1	10	410	153	0,28	mc. 0,002			

09 + 03 + 04 + 05 + 06 + 07 + 08 + 02

05

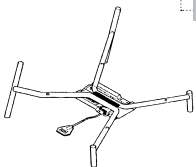

4 LEGS OPTIONS:

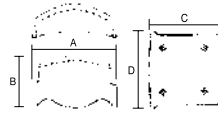

05 VICTOR-COPPIA SEDILE SCHIENALE IN PLASTICA COLORATO		Q. KIT	Q. MIN/PACK	A	B	C	D	KG.x1/WT.x1	VOL.x1/UNIT VOL.
VICTOR-PLASTIC SEAT/BACK COLOURED AT SIGHT									
CODICE/CODE	FINITURA/FINISHING								
134003-037	■ NERO/BLACK	x1	10	500	322	430	480	1,42	mc. 0,02
134015-037	■ BLU/BLUE RAL 5002	x1	10	500	322	430	480	1,42	mc. 0,02

+ 07 VITE / SCREW

SWIVEL OPTIONS:

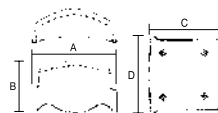

05 VICTOR-COPPIA SEDILE SCHIENALE IN PLASTICA COLORATO		Q. KIT	Q. MIN/PACK	A	B	C	D	KG.x1/WT.x1	VOL.x1/UNIT VOL.
VICTOR-PLASTIC SEAT/BACK COLOURED AT SIGHT									
CODICE/CODE	FINITURA/FINISHING								
134003-037	■ NERO/BLACK	x1	10	500	322	430	480	1,42	mc. 0,02
134015-037	■ BLU/BLUE RAL 5002	x1	10	500	322	430	480	1,42	mc. 0,02

+ 07 VITE / SCREW



PER I COMPONENTI DELLA PANCA VAI A PAG. 337
FOR THE BENCH COMPONENTS GO TO PAGE 337

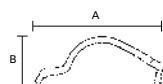
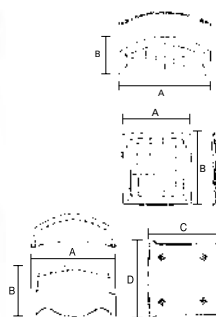
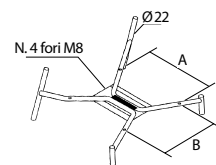

10	VICTOR-TELAIO PER PANCA TAPPI ESCLUSI VICTOR-BENCH FRAME, CAPS EXCLUDED								
CODICE/CODE	FINITURA/FINISHING	Q. KIT	Q. MIN/PACK	A	B	KG. x1/WT.x1	VOL. x1/UNIT VOL.		
110703-070	■ NERO/BLACK	x1	80	265	285	2,10	mc. 0,02		
110704-020	■ GRIGIO/GREY	x1	80	265	285	2,10	mc. 0,02		
02	TAPPO Ø22 TESTA SFERICA CAP Ø22 SPHERICAL HEAD								
CODICE/CODE	FINITURA/FINISHING	Q. KIT							
134203-224	■ NERO/BLACK	x4							
134204-220	■ GRIGIO/GREY RAL 9006	x4							
03	VICTOR-PANNELLO SCHIENALE DA TAPPEZZARE VICTOR-PANEL BACK FOR UPHOLSTERY								
CODICE/CODE	FINITURA/FINISHING	Q. KIT	Q. MIN/PACK	A	B	KG. x1/WT.x1	VOL. x1/UNIT VOL.		
132103-021	■ NERO/BLACK	x1	20	395	158	0,57	mc. 0,002		
04	VICTOR-PANNELLO SEDILE DA TAPPEZZARE VICTOR-PANEL SEAT FOR UPHOLSTERY								
CODICE/CODE	FINITURA/FINISHING	Q. KIT	Q. MIN/PACK	A	B	KG. x1/WT.x1	VOL. x1/UNIT VOL.		
132203-021	■ NERO/BLACK	x1	20	395	415	0,396	mc. 0,004		
05	VICTOR-COPPIA SEDILE SCHIENALE IN PLASTICA COLORATO VICTOR-PLASTIC SEAT/BACK COLOURED AT SIGHT								
CODICE/CODE	FINITURA/FINISHING	Q. KIT	Q. MIN/PACK	A	B	C	D	KG. x1/WT.x1	VOL. x1/UNIT VOL.
134003-037	■ NERO/BLACK	x1	10	500	322	430	480	1,42	mc. 0,02
134015-037	■ BLU/BLUE RAL 5002	x1	10	500	322	430	480	1,42	mc. 0,02
06	VITE TBL +FR 5X14 PER PANNELLO DA TAPPEZZARE SCREW TBL +FR 5X14 FOR UPHOLSTERY PANEL								
CODICE/CODE	FINITURA/FINISHING	Q. KIT							
117803-156	■ NERO/BLACK	x10							
07	VITE TGS +HILO D.5X35 CEMENTATA PER FISSAGGIO SEDILE SCREW TGS +HILO D.5X35 FOR FIXING SEAT								
CODICE/CODE	FINITURA/FINISHING	Q. KIT							
117811-153	■ ZINCATA/ZINC	x4							
08	VICTOR-BRACCIOLO SINISTRO E DESTRO VICTOR-LEFT AND RIGHT ARM								
CODICE/CODE	FINITURA/FINISHING	Q. KIT	Q. MIN/PACK	A	B	KG. x1/WT.x1	VOL. x1/UNIT VOL.		
131703-020	■ NERO/BLACK DESTRO/RIGHT	x1	10	410	153	0,28	mc. 0,002		
131703-021	■ NERO/BLACK SINISTRO/LEFT	x1	10	410	153	0,28	mc. 0,002		

10 + 03 + 04 + 05 + 06 + 07 + 08 + 02

05

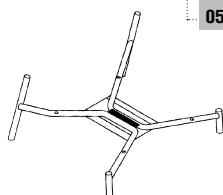

OPTIONAL GAMBA
LEG OPTIONAL





WHAT TIME IS IT?





4 LEGS



CONFORT



CONFORT 4 LEGS

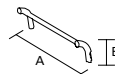
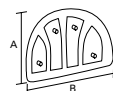
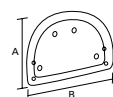
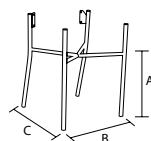

01	CONFORT-TELAIO QUATTRO GAMBE FISSO PER BRACCIOLI SENZA TAPPI CONFORT-FIXED FOUR LEGS FRAME FOR ARMS WITHOUT CAPS							
CODICE/CODE	FINITURA/FINISHING	Q. KIT	Q. MIN/PACK	A	B	C	KG. x1/WT.x1	VOL. x1/UNIT VOL.
112603-050	■ NERO/BLACK	x1	80	450	500	425	3,20	mc. 0,035
112604-050	■ GRIGIO/GREY	x1	80	450	500	425	3,20	mc. 0,035
112610-050	■ CROMATO/CHROME	x1	80	450	500	425	3,20	mc. 0,035
02	PUNTALE ALETTATO TONDO D.25 NERO BLACK INNER CAP D.25							
CODICE/CODE	FINITURA/FINISHING	Q. KIT						
134203-253	■ NERO/BLACK	x4						
03	CONFORT-SCHIENALE INTERNO DA TAPPEZZARE CONFORT-INSIDE BACK FOR UPHOLSTERY							
CODICE/CODE	FINITURA/FINISHING	Q. KIT	Q. MIN/PACK	A	B			
132103-050	■ NERO/BLACK	x1	20	305	450			
04	CONFORT-SCHIENALE ESTERNO PLASTICA CONFORT-OUTER PLASTIC BACK							
CODICE/CODE	FINITURA/FINISHING	Q. KIT	Q. MIN/PACK	A	B			
132103-051	■ NERO/BLACK	x1	20	305	450			
05	CONFORT-SEDILE INTERNO DA TAPPEZZARE CONFORT-INSIDE SEAT FOR UPHOLSTERY							
CODICE/CODE	FINITURA/FINISHING	Q. KIT	Q. MIN/PACK	A	B			
132203-060	■ NERO/BLACK	x1	20	425	435			
06	COPIA BRACCIOLI DESTRO/SINISTRO IN PLASTICA PAIR OF PLASTIC ARMS RIGHT/LEFT							
CODICE/CODE	FINITURA/FINISHING	Q. KIT	Q. MIN/PACK	A	B			
131703-047	■ NERO/BLACK	x1	20	410	153			
07	VITE M6X30 TESTA SVASATA A CROCE BRUNITA NERA (VITE PER FISSAGGI SEDILE) FLARED CROSS HEAD SCREW M6X30 BLACK BURNISHING (SCREW FOR SEAT FIXING)							
CODICE/CODE	FINITURA/FINISHING	Q. KIT						
117703-189	■ NERO/BLACK	x4						
08	VITE M6X20 TESTA SVASATA A CROCE BRUNITA NERA (VITE PER FISSAGGIO SCHIENALE) FLARED CROSS HEAD SCREW M6X20 BLACK BURNISHING (SCREW FOR BACK FIXING)							
CODICE/CODE	FINITURA/FINISHING	Q. KIT						
117703-184	■ NERO/BLACK	x4						

01 03 + 04 + 05 + 06 + 07 + 08 + 02

09 03 + 04 + 05 + 10



4 LEGS OPTIONS:

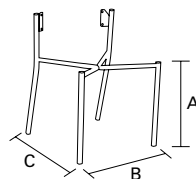

09 CONFORT-TELAIO QUATTRO GAMBE FISSO SENZA TAPPI CONFORT-FIXED FOUR LEGS FRAME WITHOUT CAPS									
CODICE/CODE	FINITURA/FINISHING	Q. KIT	Q. MIN/PACK	A	B	C	KG. x1/WT.x1	VOL. x1/UNIT VOL.	
112603-051	■ NERO/BLACK	x1	80	450	500	425	2,50	mc. 0,035	
112604-051	■ GRIGIO/GREY	x1	80	450	500	425	2,50	mc. 0,035	
112610-051	■ CROMATO/CHROME	x1	80	450	500	425	2,50	mc. 0,035	
10 TAPPO COPRITESTA ALETTATO D.25 NERO COVER HEAD D.25 BLACK									
CODICE/CODE	FINITURA/FINISHING	Q. KIT							
134103-250	■ NERO/BLACK	x4							
02 PUNTALE ALETTATO TONDO D.25 NERO BLACK INNER CAP D.25									
CODICE/CODE	FINITURA/FINISHING	Q. KIT							
134203-253	■ NERO/BLACK	x4							





SLIDE



4 LEGS



SWIVEL



MOON



EN 15373



EN 13761

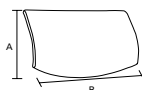
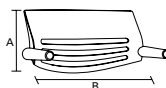
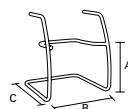
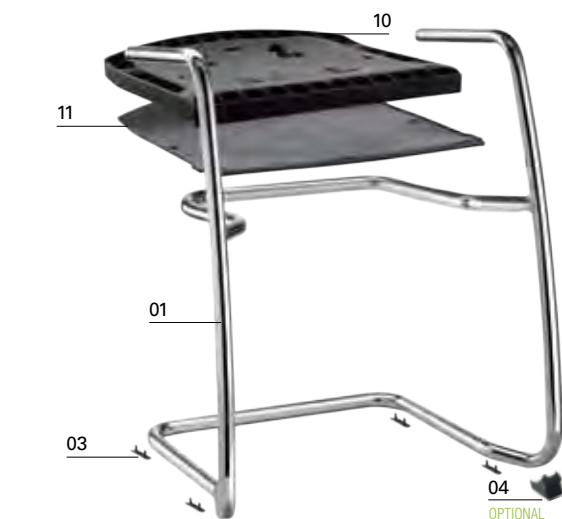

OPTIONAL

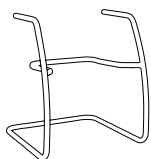
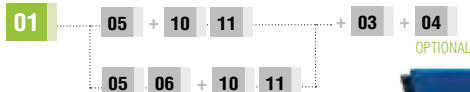

01	MOON-BASE A SLITTA IN TUBO ASFORM D.25 TAPPI ESCLUSI MOON-SLIDE FRAME PIPE D. 25 WITHOUT CAPS								
CODICE/CODE	FINITURA/FINISHING	Q. KIT	Q. MIN/PACK	A	B	C	KG.x1/WT.x1	VOL.x1/UNIT VOL.	
110503-120	■ NERO/BLACK	x1	36	450	560	550	4,80	mc. 0,045	
110504-120	■ GRIGIO/GREY	x1	36	450	560	550	4,80	mc. 0,045	
110510-120	■ CROMATO/CHROME	x1	36	450	560	550	4,80	mc. 0,045	
03	P2P PINZA DUE PIOLI IN POLITENE NERA P2P TWO-PINS PLIER IN BLACK POLYTHENE								
CODICE/CODE	FINITURA/FINISHING	Q. KIT							
134003-003	■ NERO/BLACK	x6							
04	PIEDINO ANTIRIBALTAMENTO IN PLASTICA NERO PLASTIC BLACK FEET ANTI-UPSETTING								
CODICE/CODE	FINITURA/FINISHING	Q. KIT	Q. MIN/PACK				KG.x1/WT.x1	VOL.x1/UNIT VOL.	
134303-006	■ NERO/BLACK	x2	100				0,025	mc. 0,0001	
05	MOON-SCHIENALE ESTERNO PORTANTE CON ACCESSORI MOON-INSIDE BACK CARRIER WITH ACCESSORIES								
CODICE/CODE	FINITURA/FINISHING	Q. KIT	Q. MIN/PACK	A	B		KG.x1/WT.x1	VOL.x1/UNIT VOL.	
132103-052	■ NERO/BLACK	x1	12	270	510		1,60	mc. 0,017	
132105-052	□ BIANCO/WHITE	x1	12	270	510		1,60	mc. 0,017	
06	MOON-PANNELLO SCHIENALE DA TAPPEZZARE MOON-BACK PANNEL FOR UPHOLSTERY								
CODICE/CODE	FINITURA/FINISHING	Q. KIT	Q. MIN/PACK	A	B		KG.x1/WT.x1	VOL.x1/UNIT VOL.	
132103-053	■ NERO/BLACK	x1	20	300	400		0,29	mc. 0,003	
07	VITE HILO TLB+ 5X12 CLIPPER ZINCATA NERA SCREW HILO TLB+ 5X12 CLIPPER ZINC BLACK								
CODICE/CODE	FINITURA/FINISHING	Q. KIT							
117803-151	■ NERO/BLACK	x6							
08	COPRIVITE CLIPPER IN PLASTICA NERO SCREW COVER CLIPPER IN BLACK PLASTIC								
CODICE/CODE	FINITURA/FINISHING	Q. KIT							
134403-200	■ NERO/BLACK	x6							
09	COPRIVITE CLIPPER IN PLASTICA BIANCO SCREW COVER CLIPPER IN WHITE PLASTIC								
CODICE/CODE	FINITURA/FINISHING	Q. KIT							
134405-200	□ BIANCO/WHITE	x6							
10	MOON-SEDILE INTERNO DA TAPPEZZARE MOON-INSIDE SEAT TO BE UPHOLSTERED								
CODICE/CODE	FINITURA/FINISHING	Q. KIT	Q. MIN/PACK	A	B		KG.x1/WT.x1	VOL.x1/UNIT VOL.	
132203-061	■ NERO/BLACK	x1	10	490	470		1,90	mc. 0,011	
11	MOON-SOTTOSEDILE ESTERNO PLASTICA NERO + 8 VITI MOON-EXTERNAL BLACK PLASTIC UNDERSEAT + 8 SCREWS								
CODICE/CODE	FINITURA/FINISHING	Q. KIT	Q. MIN/PACK	A	B		KG.x1/WT.x1	VOL.x1/UNIT VOL.	
132203-064	■ NERO/BLACK	x1	20	470	440		0,57	mc. 0,0025	

OPTIONAL 04
PIEDINO ANTIRIBALTAMENTO
FEET ANTI-UPSETTING



MOON 4 LEGS

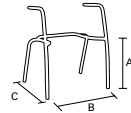

12 MOON-TELAIO QUATTRO GAMBE D.25 SENZA TAPPI MOON-FOUR LEGS FRAME D.25 WITHOUT CAPS

CODICE/CODE	FINITURA/FINISHING	Q. KIT	Q. MIN/PACK	A	B	C	KG. x1/WT.x1	VOL. x1/UNIT VOL.
112603-060	■ NERO/BLACK	x1	30	450	560	550	3,60	mc. 0,045
112604-060	■ GRIGIO/GREY	x1	30	450	560	550	3,60	mc. 0,045
112610-060	■ CROMATO/CHROME	x1	30	450	560	550	3,60	mc. 0,045

13 PUNTALE ALETTATO TESTA SFERICA D.25 NERO CAP D.25 SPHERICAL HEAD BLACK

CODICE/CODE	FINITURA/FINISHING	Q. KIT
134203-250	■ NERO/BLACK	x4

14 MOON-SEDILE INTERNO DA TAPPEZZARE PER 4 GAMBE MOON-INSIDE SEAT TO BE UPHOLSTERED FOR 4 LEGS

CODICE/CODE	FINITURA/FINISHING	Q. KIT	Q. MIN/PACK	A	B	KG. x1/WT.x1	VOL. x1/UNIT VOL.
132203-063	■ NERO/BLACK	x1	10	490	470	1,90	mc. 0,011

12 + 05 + 14 + 11 + 13

05 + 06 + 14 + 11

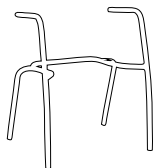

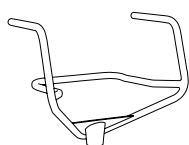
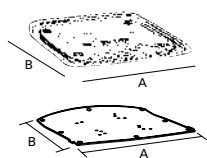
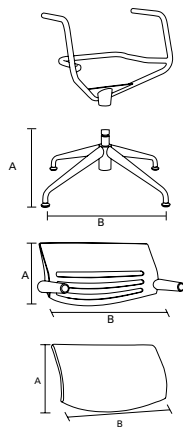

15	MOON-TELAIO GIREVOLE D.25 CON BRACCIOLI SENZA TAPPI MOON-D.25 METAL FRAME WITH SWIVEL ARMS WITHOUT CAPS								
CODICE/CODE	FINITURA/FINISHING	Q. KIT	Q. MIN/PACK			KG. x1/WT.x1	VOL. x1/UNIT VOL.		
110903-036	■ NERO/BLACK	x1	60			4,70	mc. 0,045		
110904-036	■ GRIGIO/GREY	x1	60			4,70	mc. 0,045		
110910-036	■ CROMATO/CHROME	x1	60			4,70	mc. 0,045		
16	MOON-BASE 4 RAZZE D.650 CON MECCANISMO ASSEMBLATO DI RITORNO AUTOMATICO MOON-FOUR-STAR BASE D.650 WITH AUTO-RETURN SWIVEL MECHANISM ASSEMBLED								
CODICE/CODE	FINITURA/FINISHING	Q. KIT	Q. MIN/PACK	A	B	KG. x1/WT.x1	VOL. x1/UNIT VOL.		
110210-065	■ CROMATO/CHROME	x1	100	290	500	3,00	mc. 0,04		
05	MOON-SCHIENALE ESTERNO PORTANTE CON ACCESSORI MOON-INSIDE BACK CARRIER WITH ACCESSORIES								
CODICE/CODE	FINITURA/FINISHING	Q. KIT	Q. MIN/PACK	A	B	KG. x1/WT.x1	VOL. x1/UNIT VOL.		
132103-052	■ NERO/BLACK	x1	12	270	510	1,60	mc. 0,017		
132105-052	□ BIANCO/WHITE	x1	12	270	510	1,60	mc. 0,017		
06	MOON-PANNELLO SCHIENALE DA TAPPEZZARE MOON-BACK PANNELL FOR UPHOLSTERY								
CODICE/CODE	FINITURA/FINISHING	Q. KIT	Q. MIN/PACK	A	B	KG. x1/WT.x1	VOL. x1/UNIT VOL.		
132103-053	■ NERO/BLACK	x1	20	300	400	0,29	mc. 0,003		
07	VITE HILO TLB+ 5X12 CLIPPER ZINCATA NERA SCREW HILO TLB+ 5X12 CLIPPER ZINC BLACK								
CODICE/CODE	FINITURA/FINISHING	Q. KIT							
117803-151	■ NERO/BLACK	x6							
08	COPRIVITE CLIPPER IN PLASTICA NERO SCREW COVER CLIPPER IN BLACK PLASTIC								
CODICE/CODE	FINITURA/FINISHING	Q. KIT							
134403-200	■ NERO/BLACK	x6							
09	COPRIVITE CLIPPER IN PLASTICA BIANCO SCREW COVER CLIPPER IN WHITE PLASTIC								
CODICE/CODE	FINITURA/FINISHING	Q. KIT							
134405-200	■ BIANCO/WHITE	x6							
10	MOON-SEDILE INTERNO DA TAPPEZZARE MOON-INSIDE SEAT TO BE UPHOLSTERED								
CODICE/CODE	FINITURA/FINISHING	Q. KIT	Q. MIN/PACK	A	B	KG. x1/WT.x1	VOL. x1/UNIT VOL.		
132203-061	■ NERO/BLACK	x1	10	490	470	1,90	mc. 0,011		
11	MOON-SOTTOSEDILE ESTERNO PLASTICA NERO + 8 VITI MOON-EXTERNAL BLACK PLASTIC UNDERSEAT + 8 SCREWS								
CODICE/CODE	FINITURA/FINISHING	Q. KIT	Q. MIN/PACK	A	B	KG. x1/WT.x1	VOL. x1/UNIT VOL.		
132203-064	■ NERO/BLACK	x1	20	470	440	0,57	mc. 0,0025		







MAGIX

SLIDE

4 LEGS

SWIVEL

BENCH



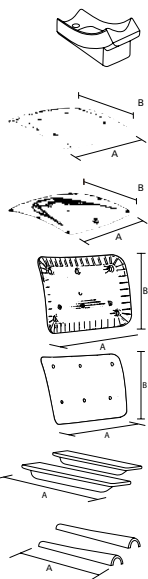
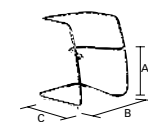

222
MAGIX

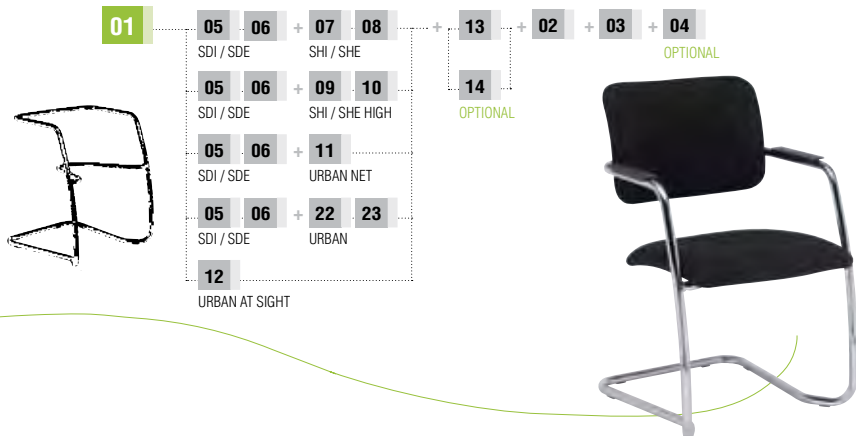

Q. KIT	Q. MIN/PACK	A	B	C	KG. x1/WT.x1	VOL. x1/UNIT VOL.
01 MAGIX-BASE A SLITTA IN TUBO ASFORM D.25 TAPPI ESCLUSI MAGIX-SLIDE FRAME PIPE D.25 WITHOUT CAPS						
CODICE/CODE	FINITURA/FINISHING					
110503-009	■ NERO/BLACK	x1	48	450 560 560	4,90	mc. 0,045
110504-112	■ GRIGIO/GREY	x1	48	450 560 560	4,90	mc. 0,045
110510-095	■ CROMATO/CHROME	x1	48	450 560 560	4,90	mc. 0,045
02 COPERTINA A PINZA D.25 IN PLASTICA NERO INNERS CAP/PLIERS COVER D.25 BLACK PLASTIC						
CODICE/CODE	FINITURA/FINISHING	Q. KIT				
134003-062	■ NERO/BLACK	x1				
03 PINZA DUE PIOLI IN POLITILENE NERA PLIERS TWO PIN BLACK						
CODICE/CODE	FINITURA/FINISHING	Q. KIT				
134003-003	■ NERO/BLACK	x6				
04 PIEDINO ANTIRIBALTAMENTO IN PLASTICA NERO PLASTIC BLACK FEET ANTI-UPSETTING						
CODICE/CODE	FINITURA/FINISHING	Q. KIT	Q. MIN/PACK			
134303-006	■ NERO/BLACK	x2	100	KG. x1/WT.x1	VOL. x1/UNIT VOL.	
				0,025	mc. 0,0001	
05 MAGIX SDI-SEDILE INTERNO PLASTICA NERO MAGIX SDI-BLACK PLASTIC INNER SEAT						
CODICE/CODE	FINITURA/FINISHING	Q. KIT	Q. MIN/PACK	A	B	
132203-035	■ NERO/BLACK	x1	10	480	460	
KG. x1/WT.x1	VOL. x1/UNIT VOL.					
1,10	mc. 0,045					
06 MAGIX SDE-SEDILE ESTERNO PLASTICA NERO MAGIX SDE-BLACK PLASTIC EXTERNAL SEAT						
CODICE/CODE	FINITURA/FINISHING	Q. KIT	Q. MIN/PACK	A	B	
132203-036	■ NERO/BLACK	x1	20	450	420	
KG. x1/WT.x1	VOL. x1/UNIT VOL.					
0,34	mc. 0,051					
07 MAGIX SHI-SCHIENALE INTERNO PLASTICA NERO MAGIX SHI-BLACK PLASTIC INNER BACK						
CODICE/CODE	FINITURA/FINISHING	Q. KIT	Q. MIN/PACK	A	B	
132103-040	■ NERO/BLACK	x1	20	470	290	
KG. x1/WT.x1	VOL. x1/UNIT VOL.					
0,95	mc. 0,004					
08 MAGIX SHE-SCHIENALE ESTERNO PLASTICA NERO MAGIX SHE-BLACK PLASTIC EXTERNAL BACK						
CODICE/CODE	FINITURA/FINISHING	Q. KIT	Q. MIN/PACK	A	B	
132103-041	■ NERO/BLACK	x1	20	470	290	
KG. x1/WT.x1	VOL. x1/UNIT VOL.					
0,26	mc. 0,055					
13 BRACCIOLO DESTRO E SINISTRO PLASTICA NERO LEFT RIGHT BLACK PLASTIC ARM						
CODICE/CODE	FINITURA/FINISHING	Q. KIT	Q. MIN/PACK	A		
131703-040	■ NERO/BLACK	x2	100	200	KG. x1/WT.x1	VOL. x1/UNIT VOL.
					0,04	mc. 0,0004
14 BRACCIOLO DESTRO E SINISTRO PLASTICA CONICO LEFT RIGHT BLACK PLASTIC CONIC ARM						
CODICE/CODE	FINITURA/FINISHING	Q. KIT	Q. MIN/PACK	A		
131703-041	■ NERO/BLACK	x2	100	205	KG. x1/WT.x1	VOL. x1/UNIT VOL.
					0,04	mc. 0,0002
17 VITE TBL +FR 5X14 BRUNITA NERA SHAVING SCREW TBL +FR 5X14 BLACK						
CODICE/CODE	FINITURA/FINISHING	Q. KIT				
117803-156	■ NERO/BLACK	x6				
18 VITE TSP+M6X35 ZINCATA SCREW TSP+M6X35 ZINC						
CODICE/CODE	FINITURA/FINISHING	Q. KIT				
117711-183	■ ZINCATA/ZINC	x4				
19 VITE TRUCCIOLORE TSP+D. 4X25 ZINCATA SHAVING SCREW TSP+D. 4X25 ZINC						
CODICE/CODE	FINITURA/FINISHING	Q. KIT				
117811-117	■ ZINCATA/ZINC	x4				
28 VITE TSPCEI M6X40 SCREW TSPCEI M6X40						
CODICE/CODE	FINITURA/FINISHING	Q. KIT				
117711-250	■ ZINCATA/ZINC	x3				

OPTIONAL 04
PIEDINO ANTIRIBALTAMENTO
FEET ANTI-UPSETTING



OPTIONAL 14
BRACCIOLO CONICO
CONIC ARM



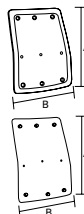

09 MAGIX SHI-SCHIENALE INTERNO ALTO PLASTICA NERO								
MAGIX SHI-INSIDE BLACK PLASTIC INNER BACK								
CODICE/CODE	FINITURA/FINISHING	Q. KIT	Q. MIN/PACK	A	B	KG.x1/WT.x1	VOL.x1/UNIT VOL.	
132103-043	■ NERO/BLACK	x1	20	540	450	1,80	mc. 0,0055	

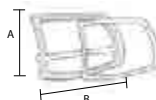

10 MAGIX SHE-SCHIENALE ALTO ESTERNO PLASTICA NERO								
MAGIX SHE-BLACK PLASTIC EXTERNAL HIGH BACK								
CODICE/CODE	FINITURA/FINISHING	Q. KIT	Q. MIN/PACK	A	B	KG.x1/WT.x1	VOL.x1/UNIT VOL.	
132103-042	■ NERO/BLACK	x1	20	540	450	0,50	mc. 0,0069	

+ 17 + 18 + 19 + 28

VITI / SCREWS

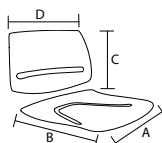

11 SCHIENALE E CORNICE PER RETE URBAN								
OUTER BACK AND OPEN FRAME FOR URBAN NET								
CODICE/CODE	FINITURA/FINISHING	Q. KIT	Q. MIN/PACK	A	B	KG.x1/WT.x1	VOL.x1/UNIT VOL.	
132103-037	■ NERO/BLACK	x1	10	288	453	0,98	mc. 0,015	

+ 17 + 18 + 19 + 20

VITI / SCREWS

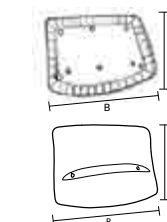

12 SEDILE E SCHIENALE A VISTA URBAN									
SEAT AND BACK SIGHT URBAN									
CODICE/CODE	FINITURA/FINISHING	Q. KIT	Q. MIN/PACK	A	B	C	D	KG.x1/WT.x1	VOL.x1/UNIT VOL.
134003-112	■ NERO/BLACK	x1	10	452	425	288	453	2,5	mc. 0,016
134004-112	■ GRIGIO/GREY	x1	10	452	425	288	453	2,5	mc. 0,016
134005-112	□ BIANCO/WHITE	x1	10	452	425	288	453	2,5	mc. 0,016

+ 18 + 19 + 20

VITI / SCREWS

22 SCHIENALE INTERNO URBAN								
INNER BACK URBAN								
CODICE/CODE	FINITURA/FINISHING	Q. KIT	Q. MIN/PACK	A	B	KG.x1/WT.x1	VOL.x1/UNIT VOL.	
132103-039	■ NERO/BLACK	x1	20	450	540	0,77	mc. 0,006	

23 SCHIENALE ESTERNO URBAN								
OUTER BACK URBAN								
CODICE/CODE	FINITURA/FINISHING	Q. KIT	Q. MIN/PACK	A	B	KG.x1/WT.x1	VOL.x1/UNIT VOL.	
132103-038	■ NERO/BLACK	x1	20	450	540	0,24	mc. 0,006	

+ 17 + 18 + 19 + 28

VITI / SCREWS

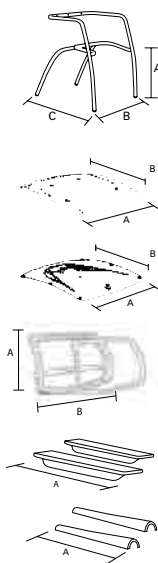

224

MAGIX

15	MAGIX-TELAIO QUATTRO GAMBE D.25 SENZA TAPPI MAGIX-FOUR LEGS FRAME D.25 WITHOUT CAPS	Q. KIT	Q. MIN/PACK	A	B	C	KG. x1/WT.x1	VOL. x1/UNIT VOL.	
CODICE/CODE	FINITURA/FINISHING								
110103-006	■ NERO/BLACK	x1	30	450	550	550	4,10	mc. 0,045	
110104-006	■ GRIGIO/GREY	x1	30	450	550	550	4,10	mc. 0,045	
110110-006	■ CROMATO/CHROME	x1	30	450	550	550	4,10	mc. 0,045	
05	MAGIX SDI-SEDILE INTERNO PLASTICA NERO MAGIX SDI-BLACK PLASTIC INNER SEAT	Q. KIT	Q. MIN/PACK	A	B		KG. x1/WT.x1	VOL. x1/UNIT VOL.	
CODICE/CODE	FINITURA/FINISHING								
132203-035	■ NERO/BLACK	x1	10	480	460		1,10	mc. 0,045	
06	MAGIX SDE-SEDILE ESTERNO PLASTICA NERO MAGIX SDE-BLACK PLASTIC EXTERNAL SEAT	Q. KIT	Q. MIN/PACK	A	B		KG. x1/WT.x1	VOL. x1/UNIT VOL.	
CODICE/CODE	FINITURA/FINISHING								
132203-036	■ NERO/BLACK	x1	20	450	420		0,34	mc. 0,051	
11	SCHIENALE E CORNICE PER RETE URBAN OUTER BACK AND OPEN FRAME FOR URBAN NET	Q. KIT	Q. MIN/PACK	A	B	C	D	KG. x1/WT.x1	VOL. x1/UNIT VOL.
CODICE/CODE	FINITURA/FINISHING								
132103-037	■ NERO/BLACK	x1	10	288	453			0,98	mc. 0,015
13	BRACCIOLLO DESTRO E SINISTRO PLASTICA NERO LEFT RIGHT BLACK PLASTIC ARM	Q. KIT	Q. MIN/PACK	A				KG. x1/WT.x1	VOL. x1/UNIT VOL.
CODICE/CODE	FINITURA/FINISHING								
131703-040	■ NERO/BLACK	x2	100	200				0,04	mc. 0,0004
14	BRACCIOLLO DESTRO E SINISTRO PLASTICA CONICO LEFT RIGHT BLACK PLASTIC CONIC ARM	Q. KIT	Q. MIN/PACK	A				KG. x1/WT.x1	VOL. x1/UNIT VOL.
CODICE/CODE	FINITURA/FINISHING								
131703-041	■ NERO/BLACK	x2	100	205				0,04	mc. 0,0002
17	VITE TBL +FR 5X14 BRUNITA NERA SHAVING SCREW TBL +FR 5X14 BLACK	Q. KIT							
CODICE/CODE	FINITURA/FINISHING								
117803-156	■ NERO/BLACK	x6							
18	VITE TSP+M6X35 ZINCATA SCREW TSP+M6X35 ZINC	Q. KIT							
CODICE/CODE	FINITURA/FINISHING								
117711-183	■ ZINCATA/ZINC	x4							
19	VITE TRUCCIOLARE TSP+D.4X25 ZINCATA SHAVING SCREW TSP+D.4X25 ZINC	Q. KIT							
CODICE/CODE	FINITURA/FINISHING								
117811-117	■ ZINCATA/ZINC	x4							
20	VITE TSPCEI M6X35 SCREW TSPCEI M6x35	Q. KIT							
CODICE/CODE	FINITURA/FINISHING								
117711-180	■ ZINCATA/ZINC	x3							
21	TAPPI-PUNTALE ALETTATO TESTA SFERICA D.25 CAPS-SPHERICAL HEAD CAP D.25	Q. KIT							
CODICE/CODE	FINITURA/FINISHING								
134203-250	■ NERO/BLACK	x4							

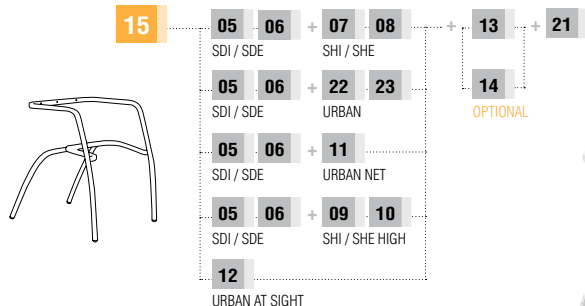

OPTIONAL 14
BRACCIOLLO CONICO
CONIC ARM



4 LEGS OPTIONS:

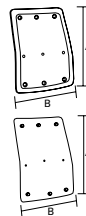

09 MAGIX SHI-SCHIENALE INTERNO ALTO PLASTICA NERO							
MAGIX SHI-INSIDE BLACK PLASTIC INNER BACK							
CODICE/CODE	FINITURA/FINISHING	Q. KIT	Q. MIN/PACK	A	B	KG. x1/WT.x1	VOL. x1/UNIT VOL.
132103-043	■ NERO/BLACK	x1	20	540	450	1,80	mc. 0,0055

10 MAGIX SHE-SCHIENALE ALTO ESTERNO PLASTICA NERO							
MAGIX SHE-BLACK PLASTIC EXTERNAL HIGH BACK							
CODICE/CODE	FINITURA/FINISHING	Q. KIT	Q. MIN/PACK	A	B	KG. x1/WT.x1	VOL. x1/UNIT VOL.
132103-042	■ NERO/BLACK	x1	20	540	450	0,50	mc. 0,0069

+ 17 + 18 + 19 + 28

VITI / SCREWS

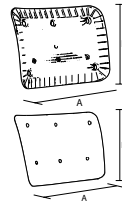

07 MAGIX SHI-SCHIENALE INTERNO PLASTICA NERO							
MAGIX SHI-BLACK PLASTIC INNER BACK							
CODICE/CODE	FINITURA/FINISHING	Q. KIT	Q. MIN/PACK	A	B	KG. x1/WT.x1	VOL. x1/UNIT VOL.
132103-040	■ NERO/BLACK	x1	20	470	290	0,95	mc. 0,004

08 MAGIX SHE-SCHIENALE ESTERNO PLASTICA NERO							
MAGIX SHE-BLACK PLASTIC EXTERNAL BACK							
CODICE/CODE	FINITURA/FINISHING	Q. KIT	Q. MIN/PACK	A	B	KG. x1/WT.x1	VOL. x1/UNIT VOL.
132103-041	■ NERO/BLACK	x1	20	470	290	0,26	mc. 0,0055

+ 17 + 18 + 19 + 28

VITI / SCREWS

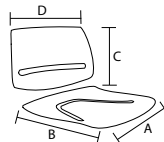

12 SEDILE E SCHIENALE A VISTA URBAN									
SEAT AND BACK SIGHT URBAN									
CODICE/CODE	FINITURA/FINISHING	Q. KIT	Q. MIN/PACK	A	B	C	D	KG. x1/WT.x1	VOL. x1/UNIT VOL.
134003-112	■ NERO/BLACK	x1	10	452	425	288	453	2,5	mc. 0,016
134004-112	■ GRIGIO/GREY	x1	10	452	425	288	453	2,5	mc. 0,016
134005-112	□ BIANCO/WHITE	x1	10	452	425	288	453	2,5	mc. 0,016

+ 18 + 19 + 20

VITI / SCREWS

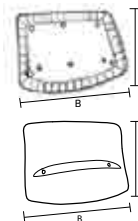

22 SCHIENALE INTERNO URBAN							
INNER BACK URBAN							
CODICE/CODE	FINITURA/FINISHING	Q. KIT	Q. MIN/PACK	A	B	KG. x1/WT.x1	VOL. x1/UNIT VOL.
132103-039	■ NERO/BLACK	x1	20	450	540	0,77	mc. 0,006

23 SCHIENALE ESTERNO URBAN							
OUTER BACK URBAN							
CODICE/CODE	FINITURA/FINISHING	Q. KIT	Q. MIN/PACK	A	B	KG. x1/WT.x1	VOL. x1/UNIT VOL.
132103-038	■ NERO/BLACK	x1	20	450	540	0,24	mc. 0,006

+ 17 + 18 + 19 + 28

VITI / SCREWS

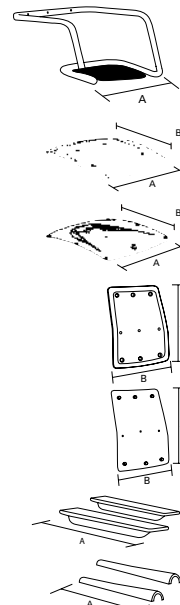

226
MAGIX

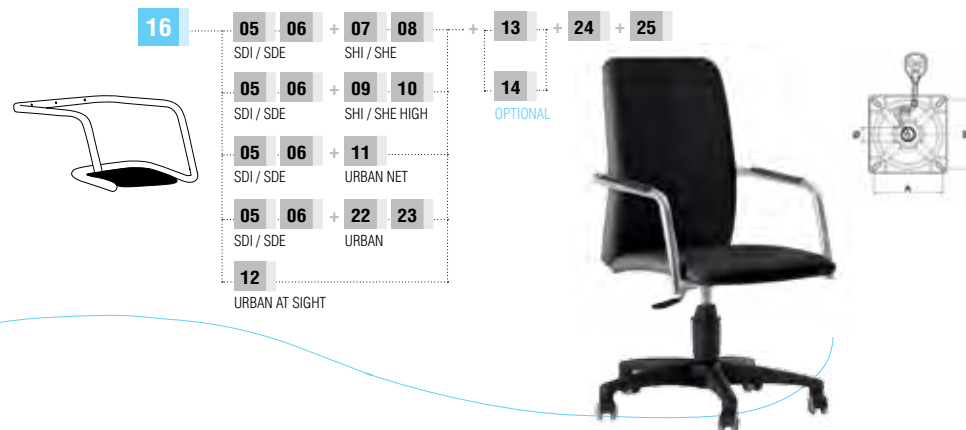

16	MAGIX-TELAIO GIREVOLE D.25 CON BRACCIOLI SENZA TAPPI MAGIX-D.25 SWIVEL/METAL FRAME ARMS WITHOUT CAPS							
CODICE/CODE	FINITURA/FINISHING	Q. KIT	Q. MIN/PACK	A	B	KG. x1/WT.x1	VOL. x1/UNIT VOL.	
110903-034	■ NERO/BLACK	x1	50	550		5,00	mc. 0,045	
110904-034	■ GRIGIO/GREY	x1	50	550		5,00	mc. 0,045	
110910-034	■ CROMATO/CHROME	x1	50	550		5,00	mc. 0,045	
05	MAGIX SDI-SEDILE INTERNO PLASTICA NERO MAGIX SDI-BLACK PLASTIC INNER SEAT							
CODICE/CODE	FINITURA/FINISHING	Q. KIT	Q. MIN/PACK	A	B	KG. x1/WT.x1	VOL. x1/UNIT VOL.	
132203-035	■ NERO/BLACK	x1	10	480	460	1,10	mc. 0,045	
06	MAGIX SDE-SEDILE ESTERNO PLASTICA NERO MAGIX SDE-BLACK PLASTIC EXTERNAL SEAT							
CODICE/CODE	FINITURA/FINISHING	Q. KIT	Q. MIN/PACK	A	B	KG. x1/WT.x1	VOL. x1/UNIT VOL.	
132203-036	■ NERO/BLACK	x1	20	450	420	0,34	mc. 0,051	
09	MAGIX SHI-SCHIENALE INTERNO ALTO PLASTICA NERO MAGIX SHI-INSIDE BLACK PLASTIC INNER BACK							
CODICE/CODE	FINITURA/FINISHING	Q. KIT	Q. MIN/PACK	A	B	KG. x1/WT.x1	VOL. x1/UNIT VOL.	
132103-043	■ NERO/BLACK	x1	20	540	450	1,80	mc. 0,0055	
10	MAGIX SHE-SCHIENALE ALTO ESTERNO PLASTICA NERO MAGIX SHE-BLACK PLASTIC EXTERNAL HIGH BACK							
CODICE/CODE	FINITURA/FINISHING	Q. KIT	Q. MIN/PACK	A	B	KG. x1/WT.x1	VOL. x1/UNIT VOL.	
132103-042	■ NERO/BLACK	x1	20	540	450	0,50	mc. 0,0069	
13	BRACCIOLLO DESTRO E SINISTRO PLASTICA NERO LEFT RIGHT BLACK PLASTIC ARM							
CODICE/CODE	FINITURA/FINISHING	Q. KIT	Q. MIN/PACK	A		KG. x1/WT.x1	VOL. x1/UNIT VOL.	
131703-040	■ NERO/BLACK	x2	100	200		0,04	mc. 0,0004	
14	BRACCIOLLO DESTRO E SINISTRO PLASTICA CONICO LEFT RIGHT BLACK PLASTIC CONIC ARM							
CODICE/CODE	FINITURA/FINISHING	Q. KIT	Q. MIN/PACK	A		KG. x1/WT.x1	VOL. x1/UNIT VOL.	
131703-041	■ NERO/BLACK	x2	100	205		0,04	mc. 0,0002	
17	VITE TBL +FR 5X14 BRUNITA NERA SHAVING SCREW TBL +FR 5X14 BLACK							
CODICE/CODE	FINITURA/FINISHING	Q. KIT						
117803-156	■ NERO/BLACK	x6						
18	VITE TSP+M6X35 ZINCATA SCREW TSP+M6X35 ZINC							
CODICE/CODE	FINITURA/FINISHING	Q. KIT						
117711-183	■ ZINCATA/ZINC	x4						
19	VITE TRUCCIOLARE TSP+D.4X25 ZINCATA SHAVING SCREW TSP+D.4X25 ZINC							
CODICE/CODE	FINITURA/FINISHING	Q. KIT						
117811-117	■ ZINCATA/ZINC	x4						
28	VITE TSPCEI M6X40 SCREW TSPCEI M6X40							
CODICE/CODE	FINITURA/FINISHING	Q. KIT						
117711-250	■ ZINCATA/ZINC	x3						
24	TAPPO COPRITESTA ALETTATO D.25 NERO COVER HEAD D.25 BLACK							
CODICE/CODE	FINITURA/FINISHING	Q. KIT						
134103-250	■ NERO/BLACK	x2						
25	PSS28NR-PIASTRA SGABELLO C/SPAT. C/28 3° L4 NERA PSS28NR- SQUARE METAL PLATE WITH STRAIGHT LEVER C/28 3° L4							
CODICE/CODE	FINITURA/FINISHING	Q. KIT	Q. MIN/PACK	A	B	Ø	KG. x1/WT.x1	VOL. x1/UNIT VOL.
113003-104	■ NERO/BLACK	x1	20	150	150	28	1,23	mc. 0,002

OPTIONAL 14

BRACCIOLLO CONICO
CONIC ARM



SWIVEL OPTIONS:

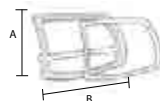

11 SCHIENALE E CORNICE PER RETE URBAN OUTER BACK AND OPEN FRAME FOR URBAN NET								
CODICE/CODE	FINITURA/FINISHING	Q. KIT	Q. MIN/PACK	A	B	KG. x1/WT.x1	VOL. x1/UNIT VOL.	
132103-037	■ NERO/BLACK	x1	10	288	453	0,98	mc. 0,015	

+ 17 + 18 + 19 + 20

VITI / SCREWS

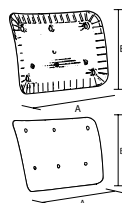

07 MAGIX SHI-SCHIENALE INTERNO PLASTICA NERO MAGIX SHI-BLACK PLASTIC INNER BACK								
CODICE/CODE	FINITURA/FINISHING	Q. KIT	Q. MIN/PACK	A	B	KG. x1/WT.x1	VOL. x1/UNIT VOL.	
132103-040	■ NERO/BLACK	x1	20	470	290	0,95	mc. 0,004	

08 MAGIX SHE-SCHIENALE ESTERNO PLASTICA NERO MAGIX SHE-BLACK PLASTIC EXTERNAL BACK								
CODICE/CODE	FINITURA/FINISHING	Q. KIT	Q. MIN/PACK	A	B	KG. x1/WT.x1	VOL. x1/UNIT VOL.	
132103-041	■ NERO/BLACK	x1	20	470	290	0,26	mc. 0,055	

+ 17 + 18 + 19 + 28

VITI / SCREWS

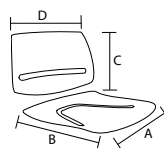

12 SEDILE E SCHIENALE A VISTA URBAN SEAT AND BACK SIGHT URBAN									
CODICE/CODE	FINITURA/FINISHING	Q. KIT	Q. MIN/PACK	A	B	C	D	KG. x1/WT.x1	VOL. x1/UNIT VOL.
134003-112	■ NERO/BLACK	x1	10	452	425	288	453	2,5	mc. 0,016
134004-112	■ GRIGIO/GREY	x1	10	452	425	288	453	2,5	mc. 0,016
134005-112	□ BIANCO/WHITE	x1	10	452	425	288	453	2,5	mc. 0,016

+ 18 + 19 + 20

VITI / SCREWS

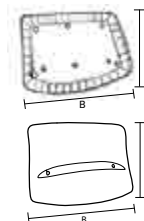

22 SCHIENALE INTERNO URBAN INNER BACK URBAN								
CODICE/CODE	FINITURA/FINISHING	Q. KIT	Q. MIN/PACK	A	B	KG. x1/WT.x1	VOL. x1/UNIT VOL.	
132103-039	■ NERO/BLACK	x1	20	450	540	0,77	mc. 0,006	

23 SCHIENALE ESTERNO URBAN OUTER BACK URBAN								
CODICE/CODE	FINITURA/FINISHING	Q. KIT	Q. MIN/PACK	A	B	KG. x1/WT.x1	VOL. x1/UNIT VOL.	
132103-038	■ NERO/BLACK	x1	20	450	540	0,24	mc. 0,006	

+ 17 + 18 + 19 + 28

VITI / SCREWS

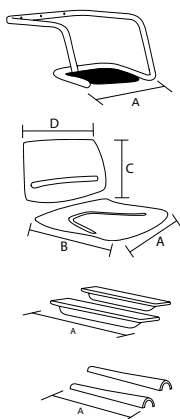

PER GLI ALTRI COMPONENTI DELLA PANCA VAI A PAG. 337
FOR THE OTHER BENCH COMPONENTS GO TO PAGE 337

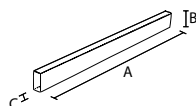

228
MAGIX

27 MAGIX-TELAIO PANCA D.25 CON BRACCIOLI SENZA TAPPI MAGIX-D 25 BENCH METAL FRAME ARMS WITHOUT CAPS						
CODICE/CODE	FINITURA/FINISHING	Q.KIT	Q.MIN/PACK	A	KG.x1/WT.x1	VOL.x1/UNIT VOL.
110703-200	■ NERO/BLACK	x1	60	550	5,00	mc. 0,045
110704-200	■ GRIGIO/GREY	x1	60	550	5,00	mc. 0,045
110710-200	■ CROMATO/CHROME	x1	60	550	5,00	mc. 0,045

12 SEDILE E SCHIENALE A VISTA URBAN SEAT AND BACK SIGHT URBAN									
CODICE/CODE	FINITURA/FINISHING	Q.KIT	Q.MIN/PACK	A	B	C	D	KG.x1/WT.x1	VOL.x1/UNIT VOL.
134003-112	■ NERO/BLACK	x1	10	452	425	288	453	2,5	mc. 0,016
134004-112	■ GRIGIO/GREY	x1	10	452	425	288	453	2,5	mc. 0,016
134005-112	□ BIANCO/WHITE	x1	10	452	425	288	453	2,5	mc. 0,016

13 BRACCIOLO DESTRO E SINISTRO PLASTICA NERO LEFT RIGHT BLACK PLASTIC ARM						
CODICE/CODE	FINITURA/FINISHING	Q.KIT	Q.MIN/PACK	A	KG.x1/WT.x1	VOL.x1/UNIT VOL.
131703-040	■ NERO/BLACK	x2	100	200	0,04	mc. 0,0004

14 BRACCIOLO DESTRO E SINISTRO PLASTICA CONICO LEFT RIGHT BLACK PLASTIC CONIC ARM						
CODICE/CODE	FINITURA/FINISHING	Q.KIT	Q.MIN/PACK	A	KG.x1/WT.x1	VOL.x1/UNIT VOL.
131703-041	■ NERO/BLACK	x2	100	205	0,04	mc. 0,0002

18 VITE TSP+M6X35 ZINCATA SCREW TSP+M6X35 ZINC						
CODICE/CODE	FINITURA/FINISHING	Q.KIT				
117711-183	■ ZINCATA/ZINC	x4				

19 VITE TRUCCIOLARE TSP+D.4X25 ZINCATA SHAVING SCREW TSP+D.4X25 ZINC						
CODICE/CODE	FINITURA/FINISHING	Q.KIT				
117811-117	■ ZINCATA/ZINC	x4				

20 VITE TSPCEI M6X35 SCREW TSPCEI M6x35						
CODICE/CODE	FINITURA/FINISHING	Q.KIT				
117711-180	■ ZINCATA/ZINC	x3				

24 TAPPO COPRITESTA ALETTATO D.25 NERO COVER HEAD D.25 BLACK						
CODICE/CODE	FINITURA/FINISHING	Q.KIT				
134103-250	■ NERO/BLACK	x2				

26 90T(03) TRAVE PER PANCA 80x40 90T(03) BEAM FOR BENCH 80X40								
CODICE/CODE	FINITURA/FINISHING	Q.KIT	Q.MIN/PACK	A	B	C	KG.x1/WT.x1	VOL.x1/UNIT VOL.
110703-190	■ NERO/BLACK	x1	1	1160	80	40	3,20	mc. 0,0045
110704-190	■ GRIGIO/GREY	x1	1	1160	80	40	3,20	mc. 0,0045
110703-191	■ NERO/BLACK	x1	1	1710	80	40	4,71	mc. 0,005
110704-191	■ GRIGIO/GREY	x1	1	1710	80	40	4,71	mc. 0,005
110703-192	■ NERO/BLACK	x1	1	2260	80	40	6,22	mc. 0,0085
110704-192	■ GRIGIO/GREY	x1	1	2260	80	40	6,22	mc. 0,0085
110703-193	■ NERO/BLACK	x1	1	2800	80	40	7,72	mc. 0,01
110704-193	■ GRIGIO/GREY	x1	1	2800	80	40	7,72	mc. 0,01

27		05	06	+	07	08	+	13	+	24	+	26	
SDI / SDE		SHI / SHE		OPTIONAL									
SDI / SDE		SHI / SHE HIGH											
SDI / SDE		URBAN NET											
SDI / SDE		URBAN											



OPTIONAL 13
BRACCIOLO PLASTICA
PLASTIC ARM



OPTIONAL GAMBA
LEG OPTIONAL









SLIDE



4 LEGS



FLASH



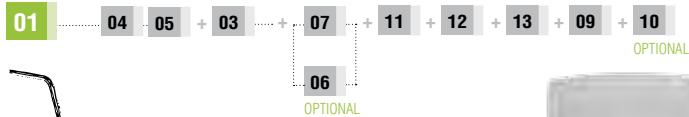
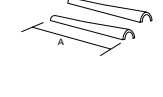
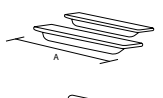
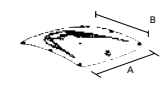
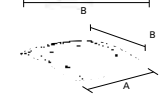
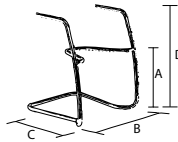

01	FLASH-BASE A SLITTA IN TUBO D.25 TAPPI ESCLUSI FLASH-SLIDE FRAME PIPE D.25 WITHOUT CAPS								
CODICE/CODE	FINITURA/FINISHING	Q. KIT	Q. MIN/PACK	A	B	C	D	KG. x1/WT.x1	VOL. x1/UNIT VOL.
110503-071	■ NERO/BLACK	x1	36	450	560	560	830	5,00	mc. 0,045
110504-071	■ GRIGIO/GREY	x1	36	450	560	560	830	5,00	mc. 0,045
110510-071	■ CROMATO/CHROME	x1	36	450	560	560	830	5,00	mc. 0,045
03	FLASH-SCHIENALE IN PLASTICA FLASH-PLASTIC BACK								
CODICE/CODE	FINITURA/FINISHING	Q. KIT	Q. MIN/PACK	A	B			KG. x1/WT.x1	VOL. x1/UNIT VOL.
132103-070	■ NERO/BLACK	x1	10	300	480			0,90	mc. 0,01
132104-070	■ GRIGIO/GREY	x1	10	300	480			0,90	mc. 0,01
04	FLASH-SEDILE INTERNO PLASTICA NERO FLASH-BLACK PLASTIC INNER SEAT								
CODICE/CODE	FINITURA/FINISHING	Q. KIT	Q. MIN/PACK	A	B			KG. x1/WT.x1	VOL. x1/UNIT VOL.
132203-035	■ NERO/BLACK	x1	10	480	460			1,10	mc. 0,045
05	FLASH-SEDILE ESTERNO PLASTICA NERO FLASH-BLACK PLASTIC EXTERNAL SEAT								
CODICE/CODE	FINITURA/FINISHING	Q. KIT	Q. MIN/PACK	A	B			KG. x1/WT.x1	VOL. x1/UNIT VOL.
132203-036	■ NERO/BLACK	x1	20	450	420			0,34	mc. 0,051
06	BRACCIOLLO DESTRO E SINISTRO PLASTICA NERO LEFT RIGHT BLACK PLASTIC ARM								
CODICE/CODE	FINITURA/FINISHING	Q. KIT	Q. MIN/PACK	A				KG. x1/WT.x1	VOL. x1/UNIT VOL.
131703-040	■ NERO/BLACK	x2	100	200				0,04	mc. 0,0004
07	BRACCIOLLO DESTRO E SINISTRO PLASTICA CONICO LEFT RIGHT BLACK PLASTIC CONIC ARM								
CODICE/CODE	FINITURA/FINISHING	Q. KIT	Q. MIN/PACK	A				KG. x1/WT.x1	VOL. x1/UNIT VOL.
131703-041	■ NERO/BLACK	x2	100	205				0,04	mc. 0,0002
09	PINZA DUE PIOLI IN POLITILENE NERA PLIERS TWO PIN BLACK								
CODICE/CODE	FINITURA/FINISHING	Q. KIT							
134003-003	■ NERO/BLACK	x6							
10	PIEDINO ANTIRIBALTAMENTO IN PLASTICA NERO PLASTIC BLACK FEET ANTI-UPSETTING								
CODICE/CODE	FINITURA/FINISHING	Q. KIT	Q. MIN/PACK					KG. x1/WT.x1	VOL. x1/UNIT VOL.
134303-006	■ NERO/BLACK	x2	100					0,025	mc. 0,0001
11	VITE TRUCCIOLARE TSP+D.4X25 ZINCATA SHAVING SCREW TSP+D.4X25 ZINC								
CODICE/CODE	FINITURA/FINISHING	Q. KIT							
117811-117	■ ZINCATA/ZINC	x4							
12	VITE TBL +FR 5X14 BRUNITA NERA SHAVING SCREW TBL +FR 5X14 BLACK								
CODICE/CODE	FINITURA/FINISHING	Q. KIT							
117803-156	■ NERO/BLACK	x6							
13	VITE 4.8TSP+M6X35 ZINCATA SCREW 4.8TSP+M6X35 ZINC								
CODICE/CODE	FINITURA/FINISHING	Q. KIT							
117711-183	■ ZINCATA/ZINC	x4							
14	VITE TRUCCIOLARE TSP+D.4X20 ZINCATA (PER FISSAGGIO SCHIENALE) SHAVING SCREW TSP+D.4X20 ZINC. (FOR FIXING BACK)								
CODICE/CODE	FINITURA/FINISHING	Q. KIT							
117811-121	■ ZINCATA/ZINC	x2							

OPTIONAL 10

PIEDINO ANTIRIBALTAMENTO
FEET ANTI-UPSETTING



OPTIONAL 06

BRACCIOLLO PLASTICA
PLASTIC ARM



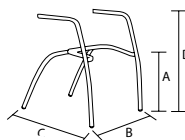

02 FLASH-TELAIO 4 GAMBE CON BRACCIOLI IN TUBO D.25 TAPPI ESCLUSI
FLASH-FOUR LEGS FRAME PIPE D.25 WITH ARMS WITHOUT CAPS

CODICE/CODE	FINITURA/FINISHING	Q. KIT	Q. MIN/PACK	A	B	C	D	KG. x1/WT.x1	VOL. x1/UNIT VOL.
110103-040	■ NERO/BLACK	x1	30	450	550	570	830	3,60	mc. 0,045
110104-040	■ GRIGIO/GREY	x1	30	450	550	570	830	3,60	mc. 0,045
110110-040	■ CROMATO/CHROME	x1	30	450	550	570	830	3,60	mc. 0,045

08 PUNTALE ALETTATO TESTA SFERICA D.25 NERO
CAP D.25 SPHERICAL HEAD BLACK

CODICE/CODE	FINITURA/FINISHING	Q. KIT
134203-250	■ NERO/BLACK	x4

OPTIONAL 07
BRACCIOLO CONICO
CONIC ARM



02 + 04 + 05 + 03 + 06 + 11 + 12 + 13 + 08

07
OPTIONAL

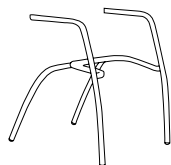



“...Is an elegantly designed, single shell armchair with an upholstered seat and the choice of mesh or upholstered back. A visitor with the appearance of an executive chair with a clever locking system between the seat and back panels.”

QNOVE





SLIDE



4 LEGS



BENCH



Q9



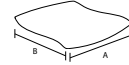
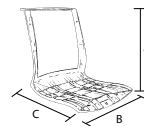
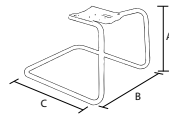

01	Q9-BASE A SLITTA IN TUBO D.25 TAPPI ESCLUSI Q9-SLIDE FRAME PIPE D.25 WITHOUT CAPS								
CODICE/CODE	FINITURA/FINISHING	Q. KIT	Q. MIN/PACK	A	B	C	KG. x1/WT.x1	VOL. x1/UNIT VOL.	
110503-131	■ NERO/BLACK	x1	64	400	560	550	4,10	mc. 0,032	
110504-131	■ GRIGIO/GREY	x1	64	400	560	550	4,10	mc. 0,032	
110510-111	■ CROMATO/CHROME	x1	64	400	560	550	4,10	mc. 0,032	
03	PIEDINO ANTIRIBALTAMENTO IN PLASTICA NERA ANTIUPSETTING BLACK PLASTIC FOOT								
CODICE/CODE	FINITURA/FINISHING	Q. KIT							
134303-006	■ NERO/BLACK	x2							
04	TAPPO COPRITESTA D.25 COVER HEAD CAP D.25								
CODICE/CODE	FINITURA/FINISHING	Q. KIT							
134110-250	■ CROMATO/CHROME	x2							
134103-250	■ NERO/BLACK	x2							
05	P2P-PINZA A DUE PIOLI IN PLASTICA P2P-PLIERS TWO PINS BLACK								
CODICE/CODE	FINITURA/FINISHING	Q. KIT							
134003-003	■ NERO/BLACK	x6							
06	Q9-MONOSCOCCA IN PLASTICA+CONFEZIONE Q9-PLASTIC SHELL + PACKAGING								
CODICE/CODE	FINITURA/FINISHING	Q. KIT	Q. MIN/PACK	A	B	C	KG. x1/WT.x1	VOL. x1/UNIT VOL.	
133903-007	■ NERO/BLACK	x1	5	550	480	480	3,20	mc. 0,021	
133905-007	□ BIANCO/WHITE	x1	5	550	480	480	3,20	mc. 0,021	
08	Q9-PANNELLO SCHIENALE IN PLASTICA DA TAPPEZZARE Q9-FRAME BACK IN PLASTIC FOR UPHOLSTERY								
CODICE/CODE	FINITURA/FINISHING	Q. KIT	Q. MIN/PACK	A	B		KG. x1/WT.x1	VOL. x1/UNIT VOL.	
132103-061	■ NERO/BLACK	x1	10	460	460		1,30	mc. 0,01	
132105-012	□ BIANCO/WHITE	x1	10	460	460		1,30	mc. 0,01	
09	Q9-PANNELLO SEDILE IN PLASTICA DA TAPPEZZARE Q9-FRAME SEAT IN PLASTIC FOR UPHOLSTERY								
CODICE/CODE	FINITURA/FINISHING	Q. KIT	Q. MIN/PACK	A	B		KG. x1/WT.x1	VOL. x1/UNIT VOL.	
132203-040	■ NERO/BLACK	x1	10	480	480		0,80	mc. 0,009	
10	VITE TESTA CILINDRICA A CROCE M6X16 ZINCATA (PER FISSARE SCOCCA) SCREW CYLINDRICAL CROSS HEAD M6X16 ZINC (FOR FIX SHELL)								
CODICE/CODE	FINITURA/FINISHING	Q. KIT							
117711-191	■ ZINCATA/ZINC	x4							

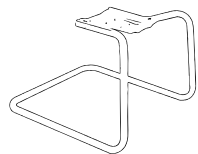

OPTIONAL 03 PIEDINO ANTIRIBALTAMENTO FEET ANTI-UPSETTING



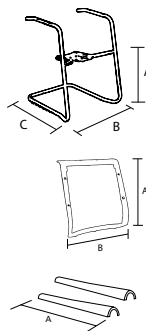

02	Q9-BASE A SLITTA CON BRACCIOLI IN TUBO D.25 TAPPI ESCLUSI Q9-SLIDE FRAME PIPE D.25 WITH ARMS WITHOUT CAPS							
CODICE/CODE	FINITURA/FINISHING	Q. KIT	Q. MIN/PACK	A	B	C	KG. x1/WT.x1	VOL. x1/UNIT VOL.
110503-095	■ NERO/BLACK	x1	36	400	560	550	5,60	mc. 0,045
110504-132	■ GRIGIO/GREY	x1	36	400	560	550	5,60	mc. 0,045
110510-132	■ CROMATO/CHROME	x1	36	400	560	550	5,60	mc. 0,045
07	Q9-CORNICE SCHIENALE IN PLASTICA PER RETE Q9-FRAME BACK IN PLASTIC MESH							
CODICE/CODE	FINITURA/FINISHING	Q. KIT	Q. MIN/PACK	A	B	KG. x1/WT.x1	VOL. x1/UNIT VOL.	
132103-060	■ NERO/BLACK	x1	20	460	460	0,52	mc. 0,007	
132105-011	□ BIANCO/WHITE	x1	20	460	460	0,52	mc. 0,007	
11	Q9-BRACCIOLO DESTRO E SINISTRO PLASTICA CONICO Q9-BLACK PLASTIC CONIC ARM							
CODICE/CODE	FINITURA/FINISHING	Q. KIT	Q. MIN/PACK	A	KG. x1/WT.x1	VOL. x1/UNIT VOL.		
131703-041	■ NERO/BLACK	x2	100	205	0,04	mc. 0,0002		
12	VITE TRUCCIOLARE TSP+ D.4X25 ZINCATA (PER FISSARE BRACCIOLI) SHAVING SCREW TSP+ D.4X25 ZINC (FOR FIX ARM)							
CODICE/CODE	FINITURA/FINISHING	Q. KIT						
117811-117	■ ZINCATA/ZINC	x4						
16	TAPPO COPRITESTA CROMATO D.25 COVER HEAD CAP D.25 CHROME							
CODICE/CODE	FINITURA/FINISHING	Q. KIT						
134110-250	■ CROMATO/CHROME	x2						

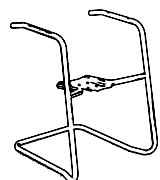

OPTIONAL 03
PIEDINO ANTIRIBALTAMENTO
FEET ANTI-UPSETTING



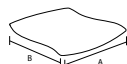
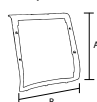
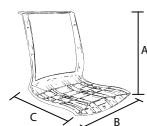
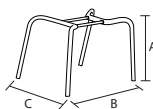

13 Q9-TELAIO 4 GAMBE IN TUBO D.25		Q. KIT		Q. MIN/PACK			A B C			KG. x1/WT.x1		VOL. x1/UNIT VOL.	
110103-035	■ NERO/BLACK	x1	150	400	530	580				3,20	mc. 0,03		
110104-035	■ GRIGIO/GREY	x1	150	400	530	580				3,20	mc. 0,03		
110110-035	■ CROMATO/CHROME	x1	150	400	530	580				3,20	mc. 0,03		

14 PUNTALE ALETTATO TESTA SFERICA D.25		Q. KIT											
134203-250	■ NERO/BLACK	x4											

06 Q9-MONOCOCCA IN PLASTICA+CONFEZIONE		Q. KIT		Q. MIN/PACK			A B C			KG. x1/WT.x1		VOL. x1/UNIT VOL.	
133903-007	■ NERO/BLACK	x1	5	550	480	480				3,20	mc. 0,021		
133905-007	□ BIANCO/WHITE	x1	5	550	480	480				3,20	mc. 0,021		

07 Q9-CORNICE SCHIENALE IN PLASTICA PER RETE		Q. KIT		Q. MIN/PACK			A B			KG. x1/WT.x1		VOL. x1/UNIT VOL.	
132103-060	■ NERO/BLACK	x1	20	460	460				0,52	mc. 0,007			
132105-011	□ BIANCO/WHITE	x1	20	460	460				0,52	mc. 0,007			

09 Q9-PANNELLO SEDILE IN PLASTICA DA TAPPEZZARE		Q. KIT		Q. MIN/PACK			A B			KG. x1/WT.x1		VOL. x1/UNIT VOL.	
132203-040	■ NERO/BLACK	x1	10	480	480				0,80	mc. 0,009			

10 VITE TESTA CILINDRICA A CROCE M6X16 ZINCATA (PER FISSARE SCOCCA)		Q. KIT											
117711-191	■ ZINCATA/ZINC	x4											

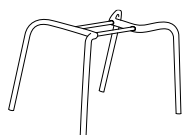
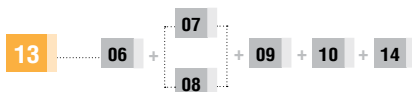

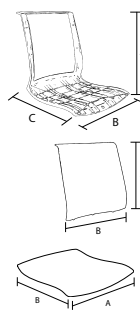

06 Q9-MONOSCOCCA IN PLASTICA+CONFEZIONE								
Q9-PLASTIC SHELL + PACKAGING								
CODICE/CODE	FINITURA/FINISHING	Q. KIT	Q. MIN/PACK	A	B	C	KG. x1/WT.x1	VOL. x1/UNIT VOL.
133903-007	■ NERO/BLACK	x1	5	550	480	480	3,20	mc. 0,021
133905-007	□ BIANCO/WHITE	x1	5	550	480	480	3,20	mc. 0,021
08 Q9-PANNELLO SCHIENALE IN PLASTICA DA TAPPEZZARE								
Q9-FRAME BACK IN PLASTIC FOR UPHOLSTERY								
CODICE/CODE	FINITURA/FINISHING	Q. KIT	Q. MIN/PACK	A	B		KG. x1/WT.x1	VOL. x1/UNIT VOL.
132103-061	■ NERO/BLACK	x1	10	460	460		1,30	mc. 0,01
132105-012	□ BIANCO/WHITE	x1	10	460	460		1,30	mc. 0,01
09 Q9-PANNELLO SEDILE IN PLASTICA DA TAPPEZZARE								
Q9-FRAME SEAT IN PLASTIC FOR UPHOLSTERY								
CODICE/CODE	FINITURA/FINISHING	Q. KIT	Q. MIN/PACK	A	B		KG. x1/WT.x1	VOL. x1/UNIT VOL.
132203-040	■ NERO/BLACK	x1	10	480	480		0,80	mc. 0,009

+ **10** VITE / SCREW



PER I COMPONENTI DELLA PANCA VAI A PAG. 337
FOR THE BENCH COMPONENTS GO TO PAGE 337

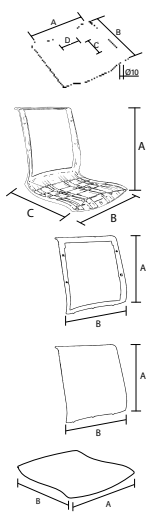

15	92P(01)-PIASTRA PER ATTACCO SCOCCA SU PANCA 92P(01)-METAL PLATE FOR SHELL FIXING ON BENCHES								
CODICE/CODE	FINITURA/FINISHING	Q. KIT	Q. MIN/PACK	A	B	C	D	KG.x1/WT.x1	VOL.x1/UNIT VOL.
110703-013	■ NERO/BLACK	x1	15	153	200	65	55	0,85	mc. 0002
06	Q9-MONOSCOCCA IN PLASTICA+CONFEZIONE Q9-PLASTIC SHELL + PACKAGING								
CODICE/CODE	FINITURA/FINISHING	Q. KIT	Q. MIN/PACK	A	B	C	KG.x1/WT.x1	VOL.x1/UNIT VOL.	
133903-007	■ NERO/BLACK	x1	5	550	480	480	3,20	mc. 0,021	
133905-007	□ BIANCO/WHITE	x1	5	550	480	480	3,20	mc. 0,021	
07	Q9-CORNICE SCHIENALE IN PLASTICA PER RETE Q9-FRAME BACK IN PLASTIC MESH								
CODICE/CODE	FINITURA/FINISHING	Q. KIT	Q. MIN/PACK	A	B	KG.x1/WT.x1	VOL.x1/UNIT VOL.		
132103-060	■ NERO/BLACK	x1	20	460	460	0,52	mc. 0,007		
132105-011	□ BIANCO/WHITE	x1	20	460	460	0,52	mc. 0,007		
08	Q9-PANNELLO SCHIENALE IN PLASTICA DA TAPPEZZARE Q9-FRAME BACK IN PLASTIC FOR UPHOLSTERY								
CODICE/CODE	FINITURA/FINISHING	Q. KIT	Q. MIN/PACK	A	B	KG.x1/WT.x1	VOL.x1/UNIT VOL.		
132103-061	■ NERO/BLACK	x1	10	460	460	1,30	mc. 0,01		
132105-012	□ BIANCO/WHITE	x1	10	460	460	1,30	mc. 0,01		
09	Q9-PANNELLO SEDILE IN PLASTICA DA TAPPEZZARE Q9-FRAME SEAT IN PLASTIC FOR UPHOLSTERY								
CODICE/CODE	FINITURA/FINISHING	Q. KIT	Q. MIN/PACK	A	B	KG.x1/WT.x1	VOL.x1/UNIT VOL.		
132203-040	■ NERO/BLACK	x1	10	480	480	0,80	mc. 0,009		
10	VITE TESTA CILINDRICA A CROCE M6X16 ZINCATA (PER FISSARE SCOCCA) SCREW CYLINDRICAL CROSS HEAD M6X16 ZINC (FOR FIX SHELL)								
CODICE/CODE	FINITURA/FINISHING	Q. KIT							
117711-191	■ ZINCATA/ZINC	x4							



OPTIONAL GAMBA
LEG OPTIONAL





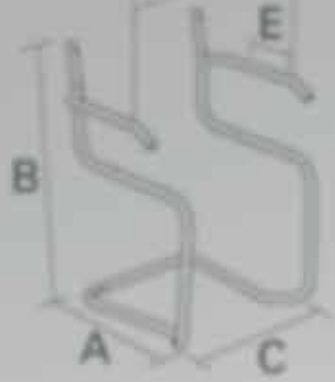

+ COMPONENTS

BASI A SLITTA

SLIDE BASES



BASI A SLITTA/SLIDE BASES COMPONENTS

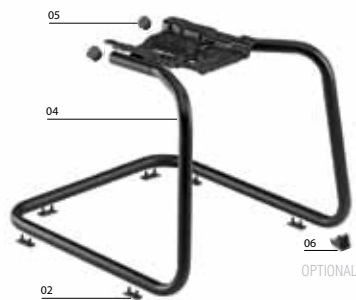
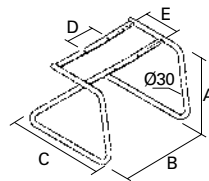

OPTIONAL

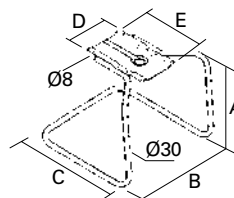

01 SL43-BASE A SLITTA IN TUBO Ø30 TAPPI ESCLUSI SL43-SLIDE FRAME PIPE Ø30 WITHOUT CAPS										
CODICE/CODE	FINITURA/FINISHING	Q.KIT	Q.MIN/PACK	A	B	C	D	E	KG.x1/WT.x1	VOL.x1/UNIT VOL.
110503-003	■ NERO/BLACK	x1	64	400	530	530	155	200	4,70	mc. 0,0313
110504-001	■ GRIGIO/GRAY	x1	64	400	530	530	155	200	4,70	mc. 0,0313
110510-020	■ CROMATO/CHROME	x1	64	400	530	530	155	200	4,70	mc. 0,0313

02 PINZA DUE PIOLI IN POLITILENE NERA TWO PINS PLIERS IN BLACK POLYTHENE										
CODICE/CODE	FINITURA/FINISHING	Q.KIT								
134003-003	■ NERO/BLACK	x4								

03 TAPPO COPRITESTA ALETTATO Ø30 NERO RIBBED INSERT Ø30 BLACK										
CODICE/CODE	FINITURA/FINISHING	Q.KIT								
134103-300	■ NERO/BLACK	x2								

04 SL40-BASE A SLITTA IN TUBO Ø25 TAPPI ESCLUSI SL40-SLIDE FRAME PIPE Ø25 WITHOUT CAPS										
CODICE/CODE	FINITURA/FINISHING	Q.KIT	Q.MIN/PACK	A	B	C	D	E	KG.x1/WT.x1	VOL.x1/UNIT VOL.
110503-021	■ NERO/BLACK	x1	96	430	480	520	170	200	4,10	mc. 0,0313
110504-010	■ GRIGIO/GRAY	x1	96	430	480	520	170	200	4,10	mc. 0,0313
110510-002	■ CROMATO/CHROME	x1	96	430	480	520	170	200	4,10	mc. 0,0313

02 PINZA DUE PIOLI IN POLITILENE NERA TWO PINS PLIERS IN BLACK POLYTHENE										
CODICE/CODE	FINITURA/FINISHING	Q.KIT								
134003-003	■ NERO/BLACK	x6								

05 TAPPO COPRITESTA ALETTATO Ø25 NERO RIBBED INSERT Ø25 BLACK										
CODICE/CODE	FINITURA/FINISHING	Q.KIT								
134103-250	■ NERO/BLACK	x2								

06 PIEDINO ANTIRIBALTAMENTO IN PLASTICA NERO PLASTIC BLACK FEET ANTI-UPSETTING										
CODICE/CODE	FINITURA/FINISHING	Q.KIT								
134303-006	■ NERO/BLACK	x2								

OPTIONAL 06

PIEDINO ANTIRIBALTAMENTO
FEET ANTI-UPSETTING

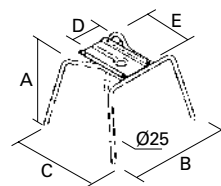

02 RG31-TELAIO FISSO IN TUBO Ø25 TAPPI ESCLUSI RG31-FIXED FRAME PIPE Ø25 WITHOUT CAPS										
CODICE/CODE	FINITURA/FINISHING	Q.KIT	Q.MIN/PACK	A	B	C	D	E	KG.x1/WT.x1	VOL.x1/UNIT VOL.
110603-012	■ NERO/BLACK	x1	150	430	470	550	170	200	3,70	mc. 0,028
110604-041	■ GRIGIO/GREY	x1	150	430	470	550	170	200	3,70	mc. 0,028
110610-017	■ CROMATO/CHROME	x1	150	430	470	550	170	200	3,70	mc. 0,028

03 PUNTALE ALETTATO TONDO Ø25 NERO RIBBED ROUND INSERT CAP Ø25 BLACK										
CODICE/CODE	FINITURA/FINISHING	Q.KIT								
134203-253	■ NERO/BLACK	x4								

BASI A SLITTA/SLIDE BASES COMPONENTS

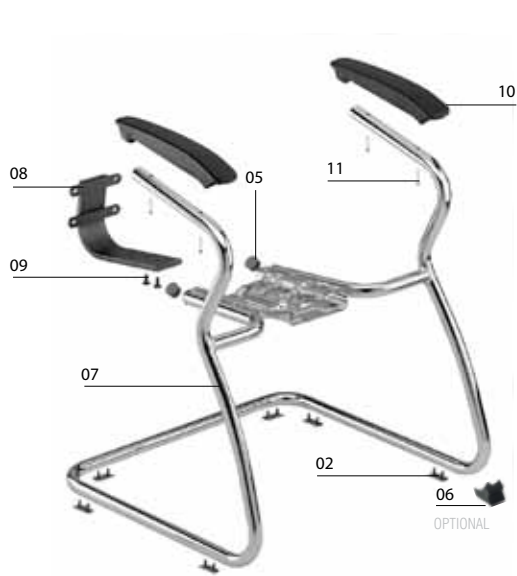

OPTIONAL 06
PIEDINO ANTIRIBALTAMENTO
FEET ANTI-UPSETTING

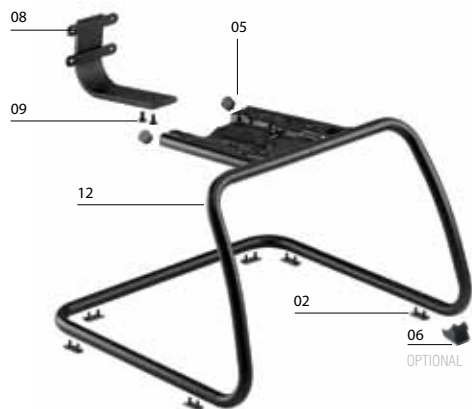
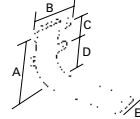
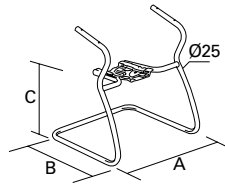

OPTIONAL 06
PIEDINO ANTIRIBALTAMENTO
FEET ANTI-UPSETTING

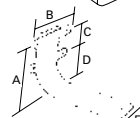
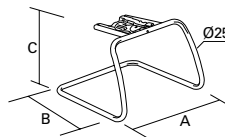

07 SL45-BASE A SLITTA IN TUBO Ø25 CON BRACCIOLI, TAPPI ESCLUSI									
SL45-SLIDE FRAME PIPE Ø25 WITH ARMS WITHOUT CAPS									
CODICE/CODE	FINITURA/FINISHING	Q. KIT	Q. MIN/PACK	A	B	C	KG. x1/WT.x1	VOL. x1/UNIT VOL.	
110503-005	■ NERO/BLACK	x1	50	590	560	400	5,50	mc. 0,055	
110504-015	■ GRIGIO/GRAY	x1	50	590	560	400	5,50	mc. 0,055	
110510-045	■ CROMATO/CHROME	x1	50	590	560	400	5,50	mc. 0,055	

02 PINZA DUE PIOLI IN POLITILENE NERA									
TWO PINS PLIERS IN BLACK POLYTHENE									
CODICE/CODE	FINITURA/FINISHING	Q. KIT							
134003-003	■ NERO/BLACK	x6							

05 TAPPO COPRITESTA ALETTATO Ø25 NERO									
RIBBED INSERT Ø25 BLACK									
CODICE/CODE	FINITURA/FINISHING	Q. KIT							
134103-250	■ NERO/BLACK	x2							

06 PIEDINO ANTIRIBALTAMENTO IN PLASTICA NERO									
PLASTIC BLACK FEET ANTI-UPSETTING									
CODICE/CODE	FINITURA/FINISHING	Q. KIT							
134303-006	■ NERO/BLACK	x2							

08 SCHIENALE FISSO PER BASE SL45/SL46										
FIXED BACK FOR BASE SL45 / SL46										
CODICE/CODE	FINITURA/FINISHING	Q. KIT	Q. MIN/PACK	A	B	C	D	E	KG. x1/WT.x1	VOL. x1/UNIT VOL.
112103-220	■ NERO/BLACK	x1	10	130	100	60	70	60	1,70	mc. 0,0015

09 VITE M8X25 TESTA CILINDRATA ESAGONO INCASSATO BRUNITA (PER FISSAGGIO LAMA/PIASTRA)									
SCREW M8X25 CYLINDRICAL HEAD EXAGON HEAT BURNISHING (FOR BLADE/PLATE)									
CODICE/CODE	FINITURA/FINISHING	Q. KIT							
117703-240	■ NERO/BLACK	x2							

10 COPRIBRACCIOLO IN POLIURENATO PER BASE SL45 TUBO Ø25									
COVER ARM IN POLYURETHENE FOR BASE SL45 TUBE Ø25									
CODICE/CODE	FINITURA/FINISHING	Q. KIT	Q. MIN/PACK	KG. x1/WT.x1	VOL. x1/UNIT VOL.				
131703-045	■ NERO/BLACK	x2	25	0,24	mc. 0,001				

11 VITE AUTOFILETTANTE 5.5X38 TESTA SVASATA A CROCE ZINCATA (PER FISSAGGIO BRACCIO)									
SCREW AUTO-THREAD 5.5X38 FLARED CROSS HEAD ZINC (FOR FIX ARM)									
CODICE/CODE	FINITURA/FINISHING	Q. KIT							
117811-165	■ ZINCATA/ZINC	x4							

12 SL46-BASE A SLITTA IN TUBO 25 TAPPI ESCLUSI									
SL46-SLIDE FRAME PIPE Ø25 WITHOUT CAPS									
CODICE/CODE	FINITURA/FINISHING	Q. KIT	Q. MIN/PACK	A	B	C	KG. x1/WT.x1	VOL. x1/UNIT VOL.	
110503-007	■ NERO/BLACK	x1	64	590	560	400	4,50	mc. 0,032	
110504-020	■ GRIGIO/GRAY	x1	64	590	560	400	4,50	mc. 0,032	
110510-047	■ CROMATO/CHROME	x1	64	590	560	400	4,50	mc. 0,032	

02 PINZA DUE PIOLI IN POLITILENE NERA									
TWO PINS PLIERS IN BLACK POLYTHENE									
CODICE/CODE	FINITURA/FINISHING	Q. KIT							
134003-003	■ NERO/BLACK	x6							

05 TAPPO COPRITESTA ALETTATO Ø25 NERO									
RIBBED INSERT Ø25 BLACK									
CODICE/CODE	FINITURA/FINISHING	Q. KIT							
134103-250	■ NERO/BLACK	x2							

06 PIEDINO ANTIRIBALTAMENTO IN PLASTICA NERO									
PLASTIC BLACK FEET ANTI-UPSETTING									
CODICE/CODE	FINITURA/FINISHING	Q. KIT							
134303-006	■ NERO/BLACK	x2							

08 SCHIENALE FISSO PER BASE SL45/SL46										
FIXED BACK FOR BASE SL45 / SL46										
CODICE/CODE	FINITURA/FINISHING	Q. KIT	Q. MIN/PACK	A	B	C	D	E	KG. x1/WT.x1	VOL. x1/UNIT VOL.
112103-220	■ NERO/BLACK	x1	10	130	100	60	70	60	1,70	mc. 0,0015

09 VITE M8X25 TESTA CILINDRATA ESAGONO INCASSATO BRUNITA (PER FISSAGGIO LAMA/PIASTRA)									
SCREW M8X25 CYLINDRICAL HEAD EXAGON HEAT BURNISHING (FOR BLADE/PLATE)									
CODICE/CODE	FINITURA/FINISHING	Q. KIT							
117703-240	■ NERO/BLACK	x2							

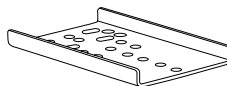

13	PIASTRA ADATTATORE PER LAMA SCHIENALE ADAPTER PLATE FOR BLADE BACK								
CODICE/CODE	FINITURA/FINISHING	Q. KIT	Q. MIN/PACK	KG. x1/WT.x1	VOL. x1/UNIT VOL.				
113003-150	■ NERO/BLACK	x1	30	0,45	mc. 0,001				

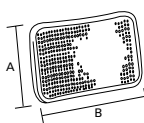
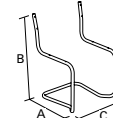
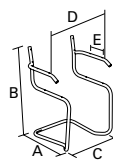

14	SL54-BASE A SLITTA IN TUBO Ø25X2 CON BRACCIOLI+TAPPI ASSEMBLATI SL54-SLIDE FRAME PIPE Ø25X2 WITH ARMS+CAPS ASSEMBLED									
CODICE/CODE	FINITURA/FINISHING	Q. KIT	Q. MIN/PACK	A	B	C	D	E	KG. x1/WT.x1	VOL. x1/UNIT VOL.
110503-037	■ NERO/BLACK	x1	80	450	770	450	500	140	4,90	mc. 0,04
110504-027	■ GRIGIO/GRAY	x1	80	450	770	450	500	140	4,90	mc. 0,04
110510-082	■ CROMATO/CHROME	x1	80	450	770	450	500	140	4,90	mc. 0,04

15	SL53-BASE A SLITTA IN TUBO Ø25X2 CON TAPPI ASSEMBLATI SL53-SLIDE FRAME PIPE Ø25X2 CAPS ASSEMBLED								
CODICE/CODE	FINITURA/FINISHING	Q. KIT	Q. MIN/PACK	A	B	C	KG. x1/WT.x1	VOL. x1/UNIT VOL.	
110503-035	■ NERO/BLACK	x1	120	450	770	450	4,10	mc. 0,04	
110504-025	■ GRIGIO/GRAY	x1	120	450	770	450	4,10	mc. 0,04	
110510-080	■ CROMATO/CHROME	x1	120	450	770	450	4,10	mc. 0,04	

16	53SH-SCHIENALE IN FAGGIO VERNICIATO IN CANNA 53SH-BEECH BACK CANE PAINTED								
CODICE/CODE	FINITURA/FINISHING	Q. KIT	Q. MIN/PACK	A	B	KG. x1/WT.x1	VOL. x1/UNIT VOL.		
122103-005	■ NERO/BLACK	x1	10	270	460	0,73	mc. 0,005		
122107-005	■ NATURALE/NATURAL	x1	10	270	460	0,73	mc. 0,005		

17	VITE TRUCCIOLARE TESTA SVASATA BOMBATA A CROCE Ø4,2X38 SHAVING SCREW FLARED ROUNDED CROSS Ø4,2X38								
CODICE/CODE	FINITURA/FINISHING	Q. KIT							
117803-126	■ NERO/BLACK	x8							
117811-127	■ ZINCATA/ZINC	x8							

18	53SD-SEDILE IN FAGGIO VERNICIATO IN CANNA 53SD-BEECH SEAT CANE PAINTED								
CODICE/CODE	FINITURA/FINISHING	Q. KIT	Q. MIN/PACK	A	B	KG. x1/WT.x1	VOL. x1/UNIT VOL.		
122203-010	■ NERO/BLACK	x1	10	415	465	1,37	mc. 0,008		
122207-010	■ NATURALE/NATURAL	x1	10	415	465	1,37	mc. 0,008		

19	53B-COPPIA BRACCIOLI IN FAGGIO VERNICIATO 53B-PAIR OF BEECH ARMS PAINTED								
CODICE/CODE	FINITURA/FINISHING	Q. KIT	Q. MIN/PACK	A	B	KG. x1/WT.x1	VOL. x1/UNIT VOL.		
121703-005	■ NERO/BLACK	x1	35	310	40	0,42	mc. 0,002		
121707-005	■ NATURALE/NATURAL	x1	35	310	40	0,42	mc. 0,002		

20	VITE AUTOFILETTANTE 5,5X38 TESTA SVASATA A CROCE ZINCATA (PER FISSAGGIO BRACCIOLO) SCREW AUTO-THREAD 5,5X38 FLARED CROSS HEAD ZINC (FOR FIX ARM)								
CODICE/CODE	FINITURA/FINISHING	Q. KIT							
117811-165	■ ZINCATA/ZINC	x4							



21	CITY-BASE A SLITTA IN TUBO ASFORM D.25+ ACCESSORI CITY -SLIDE FRAME PIPE ASFORM D.25 + ACCESSORIES								
	CODICE/CODE	FINITURA/FINISHING	Q. KIT	Q. MIN/PACK	A	B	C	KG. x1/WT.x1	VOL. x1/UNIT VOL.
	110510-055	■ CROMATO/CHROME	x1	5	450	520	550	6,50	mc. 0,045
22	PARACOLPI TESTA BOMBATA D.18 ROUND HEAD CAP D.18								
	CODICE/CODE	FINITURA/FINISHING	Q. KIT						
	134403-101	■ NERO/BLACK	x4						
23	CITY-RETE PER CITY CITY-MESH FOR CITY								
	CODICE/CODE	FINITURA/FINISHING	Q. KIT	Q. MIN/PACK				KG. x1/WT.x1	VOL. x1/UNIT VOL.
	132103-502	■ NERO/BLACK	x1	2				0,40	mc. 0,0
24	CITY-BRACCIOLO IN ALLUMINIO LUCIDO CITY-POLISHED ALUMINIUM ARM								
	CODICE/CODE	FINITURA/FINISHING	Q. KIT	Q. MIN/PACK				KG. x1/WT.x1	VOL. x1/UNIT VOL.
	111704-045	LUCIDO/POLISHED	x1	5				1,10	mc. 0,005
	111704-046	LUCIDO/POLISHED	x1	5				1,10	mc. 0,005
					DESTRO / RIGHT				
					SINISTRO / LEFT				
25	CITY-TRAVERSO MANIGLIA IN ALLUMINIO LUCIDO CITY "HANDLE-BAR" IN POLISHED ALUMINIUM								
	CODICE/CODE	FINITURA/FINISHING	Q. KIT	Q. MIN/PACK				KG. x1/WT.x1	VOL. x1/UNIT VOL.
	112104-040	LUCIDO/POLISHED	x1	10				0,60	mc. 0,007



NEW

ALBA  



AVIOR



SLIDE



4 LEGS



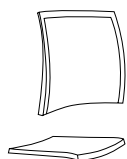
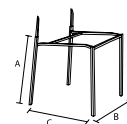
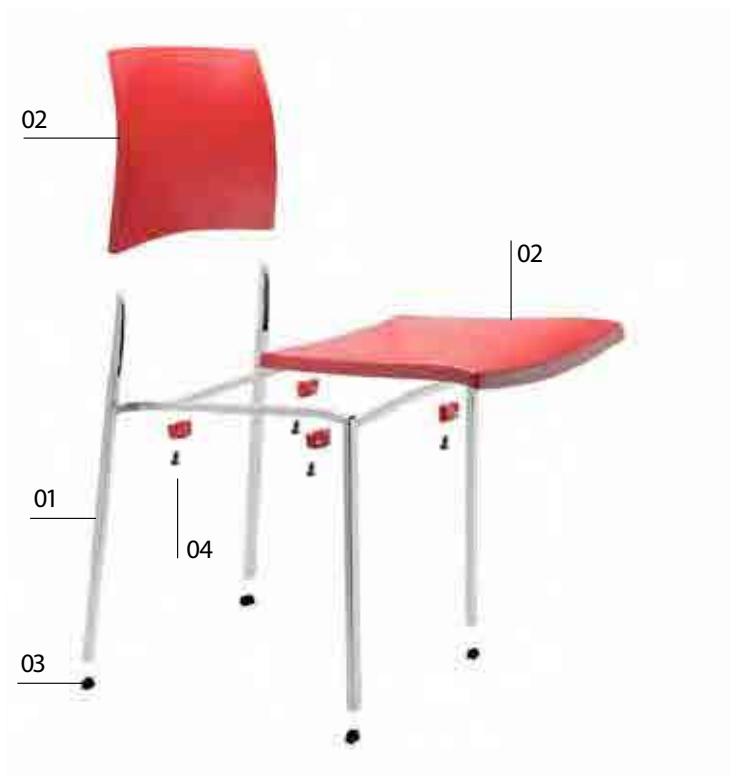

01 AVIOR-TELAIO 4 GAMBE SENZA TAPPI AVIOR-4 LEGS FRAMES WITHOUT CAPS									
CODICE/CODE	FINITURA/FINISHING		Q. KIT	Q. MIN/PACK	A	B	C	KG. x1/WT.x1	VOL. x1/UNIT VOL.
110604-049	■ GRIGIO/GREY	IKEA 4	x1	50	460	520	520	3,50	mc. 0,04
110605-001	□ BIANCO/WHITE	RAL9003	x1	50	460	520	520	3,50	mc. 0,04
110607-001	■ MARRONE/BROWN	RAL8017	x1	50	460	520	520	3,50	mc. 0,04

02 AVIOR-SEDILE E SCHIENALE COLORATO A VISTA IN PLASTICA CON AGGANCI AVIOR-PLASTIC SEAT AND BACK COLORED WITH HOOKS									
CODICE/CODE	FINITURA/FINISHING		Q. KIT	Q. MIN/PACK				KG. x1/WT.x1	VOL. x1/UNIT VOL.
134005-025	□ BIANCO/WHITE		x1	10				1,40	mc. 0,014
134007-025	■ ARANCIO/ORANGE	RAL2009	x1	10				1,40	mc. 0,014
134007-026	■ MARRONE/BROW	187	x1	10				1,40	mc. 0,014
134004-025	■ GRIGIO/GREY	RAL7022	x1	10				1,40	mc. 0,014
134002-027	■ ROSSO/RED	RAL3002	x1	10				1,40	mc. 0,014
134004-026	■ GRIGIO/GREY	RAL7003	x1	10				1,40	mc. 0,014

03 PUNTALE ALETTATO RETTANGOLARE 25x15 RIBBED RECTANGULAR INSERT 25X15			
CODICE/CODE	FINITURA/FINISHING	Q. KIT	
134203-020	■ NERO/BLACK	x4	

04 VITE HILO TB+ 5X14 CEMENTATA PER FISSAGGIO SEDILE SCREW TB+ 5X14 FOR FIXING SEAT			
CODICE/CODE	FINITURA/FINISHING	Q. KIT	
117803-155	■ NERO/BLACK	x4	

01 02 + 03 + 04



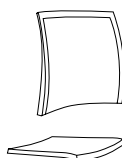
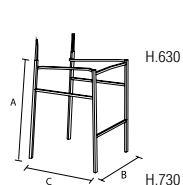

05	AVIOR-SGABELLO ALTO H.630, 4 GAMBE SENZA TAPPI AVIOR-HIGH STOOL H.630, 4 LEGS FRAMES WITHOUT CAPS							
CODICE/CODE	FINITURA/FINISHING	Q. KIT	Q. MIN/PACK	A	B	C	KG. x1/WT.x1	VOL. x1/UNIT VOL.
110604-053	■ GRIGIO/GREY IKEA 4	x1	25	630	520	520	4,75	mc. 0,08
110605-007	□ BIANCO/WHITE RAL9003	x1	25	630	520	520	4,75	mc. 0,08
110607-007	■ MARRONE/BROWN RAL8017	x1	25	630	520	520	4,75	mc. 0,08
05	AVIOR-SGABELLO ALTO H.730, 4 GAMBE SENZA TAPPI AVIOR-HIGH STOOL H.730, 4 LEGS FRAMES WITHOUT CAPS							
CODICE/CODE	FINITURA/FINISHING	Q. KIT	Q. MIN/PACK	A	B	C	KG. x1/WT.x1	VOL. x1/UNIT VOL.
110604-052	■ GRIGIO/GRAY IKEA 4	x1	25	730	520	520	5,10	mc. 0,08
110605-006	□ BIANCO/WHITE RAL9003	x1	25	730	520	520	5,10	mc. 0,08
110607-006	■ MARRONE/BROWN RAL8017	x1	25	730	520	520	5,10	mc. 0,08
02	AVIOR-SEDILE E SCHIENALE COLORATO A VISTA IN PLASTICA CON AGGANCI AVIOR-PLASTIC SEAT AND BACK COLORED WITH HOOKS							
CODICE/CODE	FINITURA/FINISHING	Q. KIT	Q. MIN/PACK	KG. x1/WT.x1	VOL. x1/UNIT VOL.			
134005-025	□ BIANCO/WHITE	x1	10	1,40	mc. 0,014			
134007-025	■ ARANCIO/ORANGE RAL2009	x1	10	1,40	mc. 0,014			
134007-026	■ MARRONE/BROW 187	x1	10	1,40	mc. 0,014			
134004-025	■ GRIGIO/GREY RAL7022	x1	10	1,40	mc. 0,014			
134002-027	■ ROSSO/RED RAL3002	x1	10	1,40	mc. 0,014			
134004-026	■ GRIGIO/GREY RAL7003	x1	10	1,40	mc. 0,014			
03	PUNTALE ALETTATO RETTANGOLARE 25x15 RIBBED RECTANGULAR INSERT 25X15							
CODICE/CODE	FINITURA/FINISHING	Q. KIT						
134203-020	■ NERO/BLACK	x4						
04	VITE HILO TB+ 5X14 CEMENTATA PER FISSAGGIO SEDILE SCREW TB+ 5X14 FOR FIXING SEAT							
CODICE/CODE	FINITURA/FINISHING	Q. KIT						
117803-155	■ NERO/BLACK	x4						

05 02 + 03 + 04

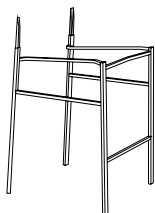

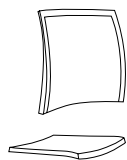
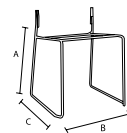
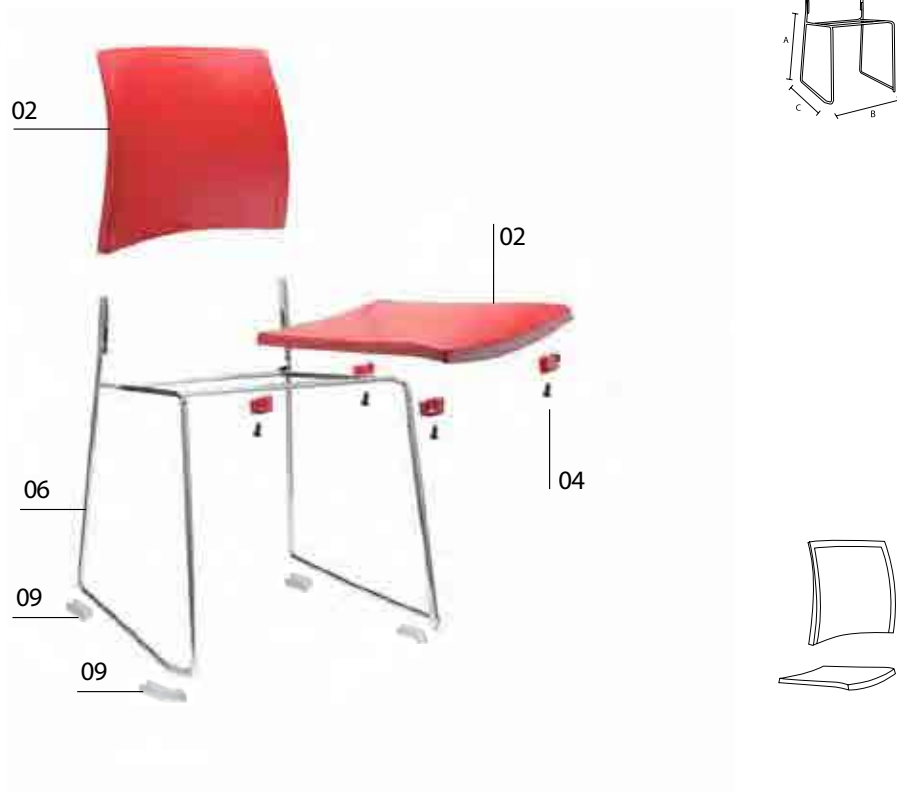

06	AVIOR-TELAIO SLITTA IN TONDINO PER SEDIA SENZA TAPPI AVIOR-SLIDE WIRE FRAME FOR CHAIR WITHOUT CAPS								
CODICE/CODE	FINITURA/FINISHING	Q. KIT	Q. MIN/PACK	A	B	C	KG. x1/WT.x1	VOL. x1/UNIT VOL.	
113410-070	■ CROMATO/CHROME	x1	60	460	500	510	4,30	mc. 0,04	
07	BASE PIANA A PINZA IN PE PER TONDO CLIPS BASE FOR TUBE								
CODICE/CODE	FINITURA/FINISHING	Q. KIT							
134006-020	□ NEUTRO/NEUTRAL	x4							
08	BASE PIANA A PINZA DOPPIA IN PE PER TONDO PER UNIONE SEDIE DOUBLE FLAT CLIP BASE FOR TUBE								
CODICE/CODE	FINITURA/FINISHING	Q. KIT							
134006-021	□ NEUTRO/NEUTRAL	x4							
09	BTF-KIT PIEDINI BTF-KIT FEET								
CODICE/CODE	FINITURA/FINISHING	Q. KIT	Q. MIN/PACK				KG. x1/WT.x1		
134306-001	□ NEUTRO/NEUTRAL	x1	100				0,05		
10	BTFA-KIT PIEDINI CON GANCI BTFA-KIT FEET WITH HOOKS								
CODICE/CODE	FINITURA/FINISHING	Q. KIT	Q. MIN/PACK				KG. x1/WT.x1		
134306-002	□ NEUTRO/NEUTRAL	x1	100				0,06		
11	PPTF-TAPPO PER FISSAGGIO PAVIMENTO PPTF-CAP FOR FIXING TO THE FLOOR								
CODICE/CODE	FINITURA/FINISHING	Q. KIT	Q. MIN/PACK				KG. x1/WT.x1		
134306-003	□ NEUTRO/NEUTRAL	x2	100				0,03		
02	AVIOR-SEDILE E SCHIENALE COLORATO A VISTA IN PLASTICA CON AGGANCI AVIOR-PLASTIC SEAT AND BACK COLORED WITH HOOKS								
CODICE/CODE	FINITURA/FINISHING	Q. KIT	Q. MIN/PACK				KG. x1/WT.x1	VOL. x1/UNIT VOL.	
134005-025	□ BIANCO/WHITE	x1	10				1,40	mc. 0,014	
134007-025	■ ARANCIO/ORANGE RAL2009	x1	10				1,40	mc. 0,014	
134007-026	■ MARRONE/BROW 187	x1	10				1,40	mc. 0,014	
134004-025	■ GRIGIO/GREY RAL7022	x1	10				1,40	mc. 0,014	
134002-027	■ ROSSO/RED RAL3002	x1	10				1,40	mc. 0,014	
134004-026	■ GRIGIO/GREY RAL7003	x1	10				1,40	mc. 0,014	
04	VITE HILO TB+ 5X14 CEMENTATA PER FISSAGGIO SEDILE SCREW TB+ 5X14 FOR FIXING SEAT								
CODICE/CODE	FINITURA/FINISHING	Q. KIT							
117803-155	■ NERO/BLACK	x4							

06 + 02 + 07 + 04

OPTIONAL
08
OPTIONAL
09
OPTIONAL
10 + 11
OPTIONAL OPTIONAL



OPTIONAL 07

BASE PIANA A PINZA
CLIPS BASE



OPTIONAL 08

BASE PIANA A PINZA DOPPIA
DOUBLE FLAT CLIP BASE



OPTIONAL 09

BTF-KIT PIEDINI
BTF-KIT FEET



OPTIONAL 10

BTFA-KIT PIEDINI CON GANCI
BTFA-KIT FEET WITH HOOKS



OPTIONAL 11

PPTF-TAPPO PER FISSAGGIO PAVIMENTO
PPTF-CAP FOR FIXING TO THE FLOOR









YEAH

SLIDE



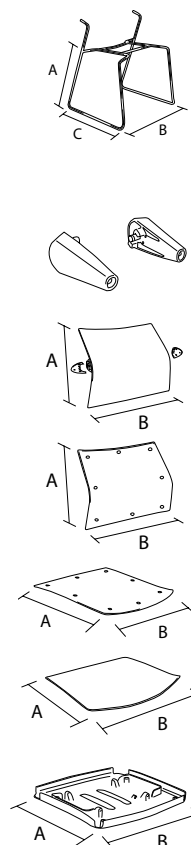
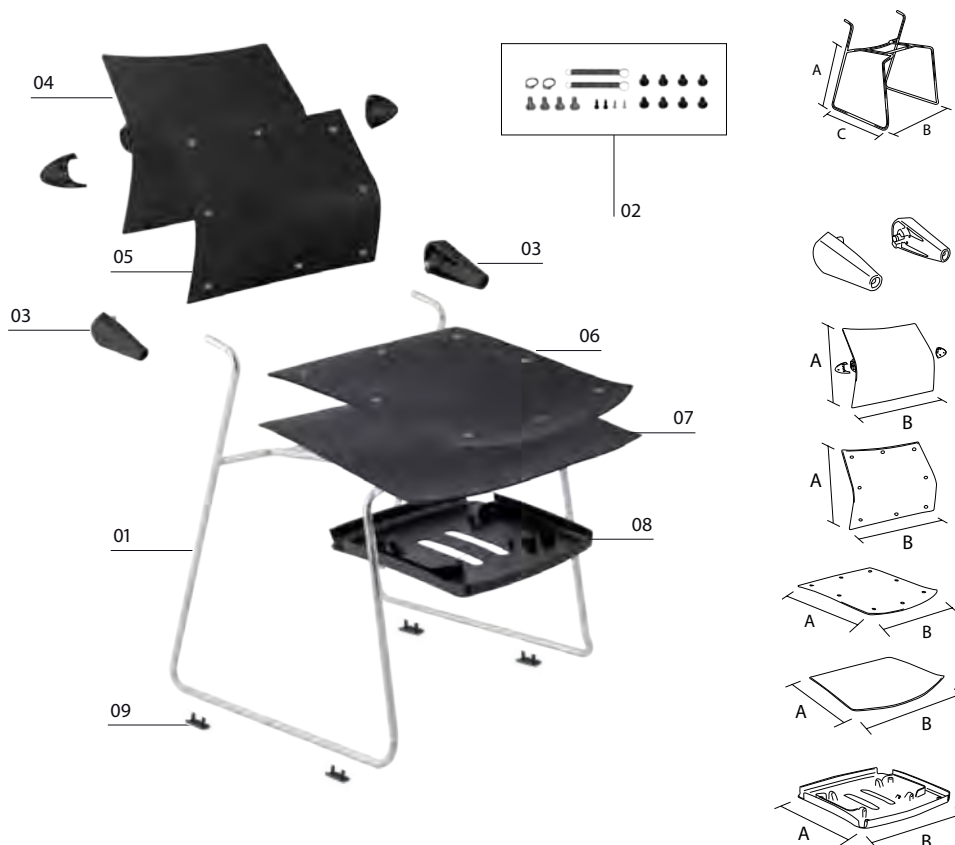

01	YEAH-TELAIO CHIUSO IN TUBO D. 14 SENZA TAPPI YEAH-SLIDE FRAME D.22 CAPS EXCLUDED								
CODICE/CODE	FINITURA/FINISHING	Q. KIT	Q. MIN/PACK	A	B	C	KG. x1/WT.x1	VOL. x1/UNIT VOL.	
112710-085	■ CROMATO/CHROME	x1	40	460	540	520	2,60	mc. 0,055	
02	YEAH-CONFEZIONE ACCESSORI PER 10 SEDIE YEAH-KIT PACKAGING FOR 10 CHAIRS								
CODICE/CODE	FINITURA/FINISHING	Q. KIT	Q. MIN/PACK						
137000-007		x1	1						
03	YEAH-BLOCCHETTO DESTRO E SINISTRO YEAH-RIGHT AND LEFT ARM								
CODICE/CODE	FINITURA/FINISHING	Q. KIT	Q. MIN/PACK				KG. x1/WT.x1	VOL. x1/UNIT VOL.	
134003-070	■ NERO/BLACK	x1	40				0,22	mc. 0,001	
134005-070	□ BIANCO/WHITE	x1	40				0,22	mc. 0,001	
134015-070	■ BLU/BLUE	x1	40				0,22	mc. 0,001	
	RAL9003								
	RAL5014								
04	YEAH-SCHIENALE ESTERNO CON COPERCHIETI YEAH-OUTER BACK WITH COVERS								
CODICE/CODE	FINITURA/FINISHING	Q. KIT	Q. MIN/PACK	A	B		KG. x1/WT.x1	VOL. x1/UNIT VOL.	
132103-087	■ NERO/BLACK	x1	10	365	485		1,10	mc. 0,006	
132105-087	□ BIANCO/WHITE	x1	10	365	485		1,10	mc. 0,006	
132115-087	■ BLU/BLUE	x1	10	365	485		1,10	mc. 0,006	
	RAL9003								
	RAL5014								
05	YEAH-PANNELLO INTERNO SCHIENALE DA TAPPEZZARE YEAH-INNER BACK PANEL FOR UPHOLSTERY								
CODICE/CODE	FINITURA/FINISHING	Q. KIT	Q. MIN/PACK	A	B		KG. x1/WT.x1	VOL. x1/UNIT VOL.	
132103-088	■ NERO/BLACK	x1	20	325	455		0,45	mc. 0,005	
06	YEAH-PANNELLO SEDILE DA TAPPEZZARE IN PLASTICA YEAH-PLASTIC SEAT PANEL FOR UPHOLSTERY								
CODICE/CODE	FINITURA/FINISHING	Q. KIT	Q. MIN/PACK	A	B		KG. x1/WT.x1	VOL. x1/UNIT VOL.	
132203-087	■ NERO/BLACK	x1	20	450	480		0,70	mc. 0,006	
07	YEAH-SEDILE PLASTICA COLORATO YEAH-COLORED PLASTIC SEAT								
CODICE/CODE	FINITURA/FINISHING	Q. KIT	Q. MIN/PACK	A	B		KG. x1/WT.x1	VOL. x1/UNIT VOL.	
132203-085	■ NERO/BLACK	x1	20	460	490		1,30	mc. 0,007	
132205-085	□ BIANCO/WHITE	x1	20	460	490		1,30	mc. 0,007	
132215-085	■ BLU/BLUE	x1	20	460	490		1,30	mc. 0,007	
	RAL9003								
	RAL5014								
08	YEAH-SOTTOSEDILE IN PLASTICA CON MOLLA YEAH-OUTER COLORED PLASTIC SEAT WITH SPRING								
CODICE/CODE	FINITURA/FINISHING	Q. KIT	Q. MIN/PACK	A	B		KG. x1/WT.x1	VOL. x1/UNIT VOL.	
132203-086	■ NERO/BLACK	x1	20	315	300		0,32	mc. 0,004	
132205-086	□ BIANCO/WHITE	x1	20	315	300		0,32	mc. 0,004	
132215-086	■ BLU/BLUE	x1	20	315	300		0,32	mc. 0,004	
	RAL9003								
	RAL5014								
09	P2P-PINZA DUE PIOLI IN POLIETILENE NERA P2P -TWO PINS PLIERS IN BLACK POLYTHENE								
CODICE/CODE	FINITURA/FINISHING	Q. KIT							
134003-003	■ NERO/BLACK	x4							

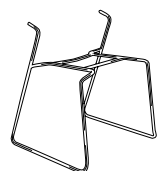







4 LEGS



EDEN



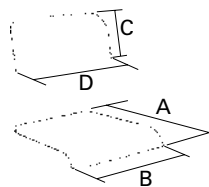
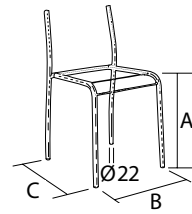

01 EDEN-TELAIO FISSO SENZA TAPPI		EDEN-FIXED FRAME WITHOUT CAPS							
CODICE/CODE	FINITURA/FINISHING	Q. KIT	Q. MIN/PACK	A	B	C	KG. x1/WT.x1	VOL. x1/UNIT VOL.	
111903-030	■ NERO/BLACK	x1	100	470	420	460	3,00	mc. 0,03	
111904-020	■ GRIGIO/GREY	x1	100	470	420	460	3,00	mc. 0,03	
111910-030	■ CROMATO/CHROME	x1	100	470	420	460	3,00	mc. 0,03	
03 PUNTALE ALETTATO TONDO Ø22 NERO		RIBBED ROUND INSERT CAP Ø22 BLACK							
CODICE/CODE	FINITURA/FINISHING	Q. KIT							
134203-220	■ NERO/BLACK	x4							
04 EDEN-SEDILE E SCHIENALE IN PLASTICA		EDEN-PLASTIC SEAT AND BACK							
CODICE/CODE	FINITURA/FINISHING	Q. KIT	Q. MIN/PACK	A	B	C	D	KG. x1/WT.x1	VOL. x1/UNIT VOL.
134003-100	■ NERO/BLACK	x1	20	400	390	180	400	1,50	mc. 0,013
134015-020	■ BLU/BLUE	x1	20	400	390	180	400	1,50	mc. 0,013
134005-020	□ AVORIO/IVORY	x1	20	400	390	180	400	1,50	mc. 0,013

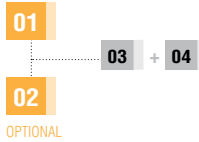

4 LEGS OPTIONS:



02 EDEN-SGABELLO ALTO FISSO SENZA TAPPI EDEN-FIXED STOOL WITHOUT CAPS									
CODICE/CODE	FINITURA/FINISHING	Q. KIT	Q. MIN/PACK	A	B	C	KG. x1/WT.x1	VOL. x1/UNIT VOL.	
111903-032	■ NERO/BLACK	x1	50	720	420	460	4,10	mc. 0,09	
111904-022	■ GRIGIO/GREY	x1	50	720	420	460	4,10	mc. 0,09	
111910-029	■ CROMATO/CHROME	x1	50	720	420	460	4,10	mc. 0,09	

03 PUNTALE ALETTATO TONDO Ø22 NERO RIBBED ROUND INSERT CAP Ø22 BLACK									
CODICE/CODE	FINITURA/FINISHING	Q. KIT							
134203-220	■ NERO/BLACK	x4							





4 LEGS



SCHOOL



SCHOOL 4 LEGS

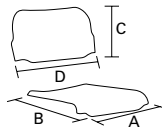
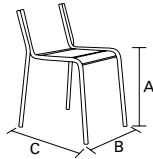

01	SCHOOL-TELAIO QUATTRO GAMBE FISSO SENZA TAPPI SCHOOL-FIXED FOUR LEGS FRAME WITHOUT CAPS										
CODICE/CODE	FINITURA/FINISHING	Q. KIT	Q. MIN/PACK	A	B	C	KG. x1/WT.x1	VOL. x1/UNIT VOL.			
110103-001	■ NERO/BLACK	x1	64	450	370	510	3,00	mc. 0,03			
110104-003	■ GRIGIO/GREY	x1	64	450	370	510	3,00	mc. 0,03			
110110-003	■ CROMATO/CHROME	x1	64	450	370	510	3,00	mc. 0,03			
02	PUNTALE ALETTATO TONDO D.22 NERO BLACK INNER CAP D.22										
CODICE/CODE	FINITURA/FINISHING	Q. KIT									
134203-220	■ NERO/BLACK	x4									
03	SCHOOL-SEDILE/SCHIENALE IN PLASTICA COLORATO A VISTA SCHOOL-PLASTIC SEAT/BACK COLOURED AT SIGHT										
CODICE/CODE	FINITURA/FINISHING	Q. KIT	Q. MIN/PACK	A	B	C	D	KG. x1/WT.x1	VOL. x1/UNIT VOL.		
134002-010	■ ROSSO/RED RAL 3002	x1	20	360	360	185	400	0,85	mc. 0,006		
134015-010	■ BLU/BLUE RAL 5017	x1	20	360	360	185	400	0,85	mc. 0,006		
04	RIVETTO D.4,8X12 TESTA TONDA D.10 ALLUMINIO(PER FISSAGGIO SEDILE) RIVET D.4,8X12 ROUND HEAD D.10 ALUMINIUM(FOR FIXING SEAT)										
CODICE/CODE	FINITURA/FINISHING	Q. KIT									
118011-124	ALLUMINIO/ALUMINIUM	x4									

264

SCHOOL

01 + 02 + 03 + 04









SMART



BENCH



LA PANCA VIENE FORNITA IN TUTTI I SUOI COMPONENTI SMONTATA
THE BENCH SUPPLIED WITH ALL ITS COMPONENTS NOT ASSEMBLED



01 SMART-PANCA A DUE POSTI GRIGIO CON DUE BRACCIOLI		Q. KIT	Q. MIN/PACK	KG. x1/WT.x1	VOL. x1/UNIT VOL.
SMART-GREY BENCH TWO SEATS WITH TWO ARMS					
CODICE/ CODE	FINITURA/ FINISHING				
110704-130	■ GRIGIO/GRAY	x1	1	28.50	mc. 0,149

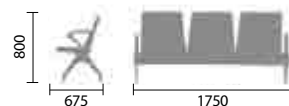

02 SMART-PANCA A TRE POSTI GRIGIO CON DUE BRACCIOLI		Q. KIT	Q. MIN/PACK	KG. x1/WT.x1	VOL. x1/UNIT VOL.
SMART-GREY BENCH THREE SEATS WITH TWO ARMS					
CODICE/ CODE	FINITURA/ FINISHING				
110704-131	■ GRIGIO/GRAY	x1	1	39.50	mc. 0,224

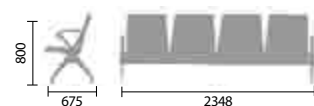

03 SMART-PANCA A QUATTRO POSTI GRIGIO CON DUE BRACCIOLI		Q. KIT	Q. MIN/PACK	KG. x1/WT.x1	VOL. x1/UNIT VOL.
SMART-GREY BENCH FOUR SEATS WITH TWO ARMS					
CODICE/ CODE	FINITURA/ FINISHING				
110704-132	■ GRIGIO/GRAY	x1	1	51.00	mc. 0,272

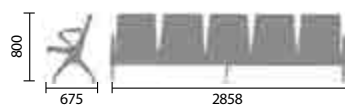
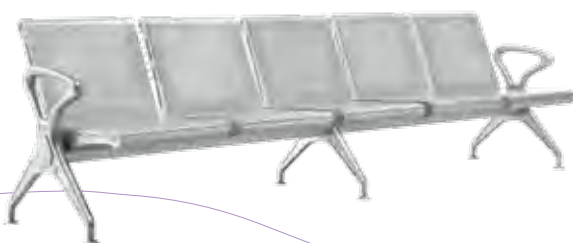

04 SMART-PANCA A CINQUE POSTI GRIGIO CON DUE BRACCIOLI		Q. KIT	Q. MIN/PACK	KG. x1/WT.x1	VOL. x1/UNIT VOL.
SMART-GREY BENCH FIVE SEATS WITH TWO ARMS					
CODICE/ CODE	FINITURA/ FINISHING				
110704-133	■ GRIGIO/GRAY	x1	1	62.50	mc. 0,378

BENCH OPTIONS:



05	SMART-PANNELLI SEDILE/SCHIENALE TAPPEZZATI SIMILPELLE NERO CON VITI				
	SMART-PANEL SEAT 6 BACK UPHOLSTERED IMITATION LEATHER WITH SCREWS				
CODICE/CODE	FINITURA/FINISHING	Q. KIT	Q. MIN/PACK	KG. x1/WT.x1	VOL. x1/UNIT VOL.
143903-003	■ NERO/BLACK	x1	1	2,50	mc. 0,014



06	SMART-TAVOLO PER PANCA IN LAMIERA GRIGIO CON VITI				
	SMART-GRAY TABLE FOR BENCH IN METAL SHEET WITH SCREWS				
CODICE/CODE	FINITURA/FINISHING	Q. KIT	Q. MIN/PACK	KG. x1/WT.x1	VOL. x1/UNIT VOL.
110704-134	■ GRIGIO/GRAY	x1	1	7,00	mc. 0,022





LOBBY
A
LEVEL
L2





ARIA



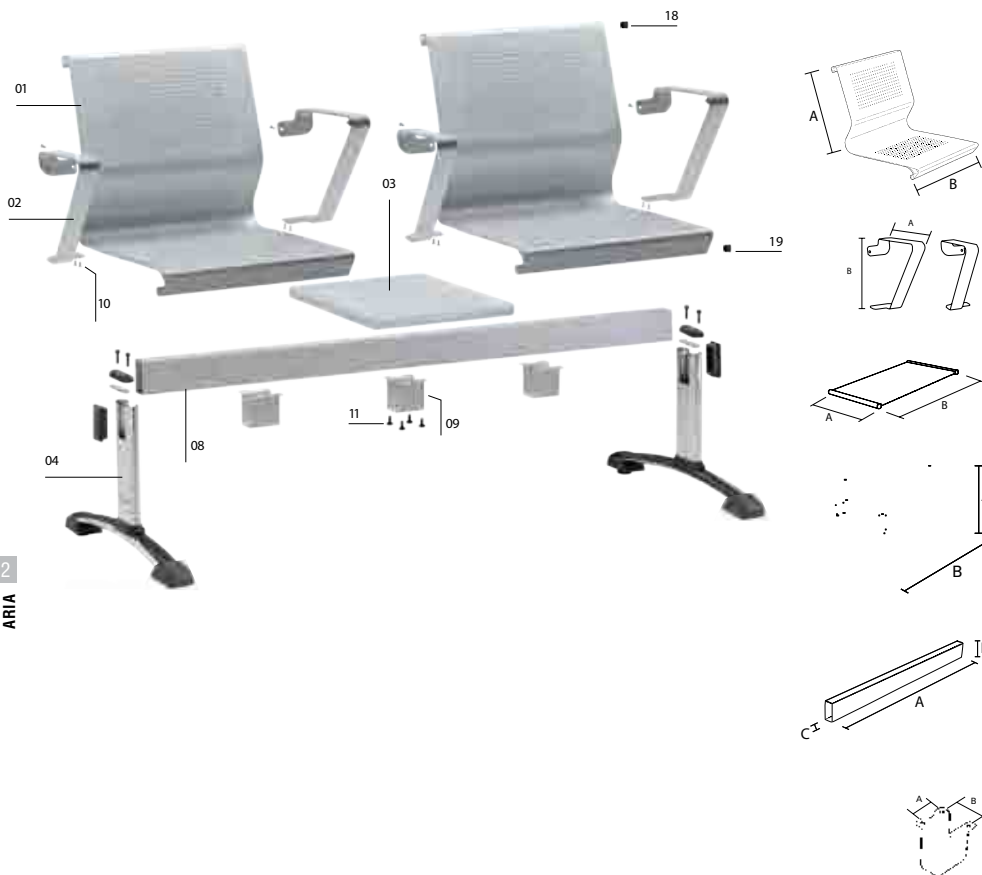

272

ARIA

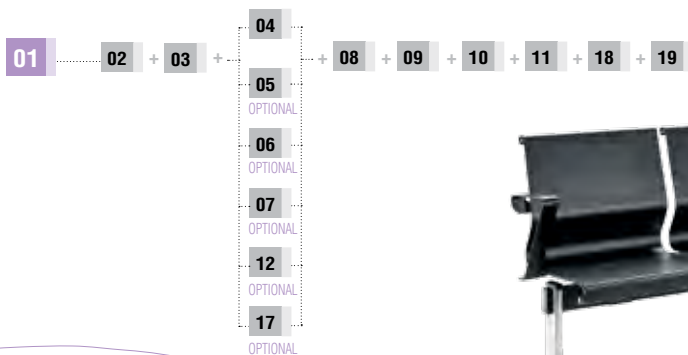

01 ARIA-SCOCCA INTERA IN LAMIERA							
ARIA-SHELL METAL SHEET							
CODICE/CODE	FINITURA/FINISHING	Q. KIT	Q. MIN/PACK	A	B	KG. x1/WT.x1	VOL. x1/UNIT VOL.
110703-065	■ NERO/BLACK	x1	25	475	490	10,50	mc. 0,02
110703-066	■ NERO/BLACK FORI X BRACC. / HOLES FOR ARMS	x1	25	475	490	10,50	mc. 0,02
110704-025	■ GRIGIO/GRAY	x1	25	475	490	10,50	mc. 0,02
110704-027	■ GRIGIO/GRAY FORI X BRACC. / HOLES FOR ARMS	x1	25	475	490	10,50	mc. 0,02

02 ARIA-BRACCIOLO IN METALLO PER SCOCCA							
ARIA-METAL ARM FOR SHELL							
CODICE/CODE	FINITURA/FINISHING	Q. KIT	Q. MIN/PACK	A	B	KG. x1/WT.x1	VOL. x1/UNIT VOL.
111703-001	■ NERO/BLACK DESTRO/RIGHT	x1	5	300	270	1,68	mc. 0,02
111703-002	■ NERO/BLACK SINISTRO/LEFT	x1	5	300	270	1,68	mc. 0,02
111704-001	■ GRIGIO/GRAY DESTRO/RIGHT	x1	5	300	270	1,68	mc. 0,02
111704-002	■ GRIGIO/GRAY SINISTRO/LEFT	x1	5	300	270	1,68	mc. 0,02

03 ARIA-TAVOLO X PANCA IN LAMIERA							
ARIA-METAL SHEET FOR BENCH							
CODICE/CODE	FINITURA/FINISHING	Q. KIT	Q. MIN/PACK	A	B	KG. x1/WT.x1	VOL. x1/UNIT VOL.
110703-069	■ NERO/BLACK	x1	25	370	500	5,5	mc. 0,01
110704-030	■ GRIGIO/GRAY	x1	25	370	500	5,5	mc. 0,01

04 90GM-GAMBA MOBILE PER PANCA CON ACCESSORI							
90GM-MOVABLE LEG FOR BENCH WITH ACCESSORIES							
CODICE/CODE	FINITURA/FINISHING	Q. KIT	Q. MIN/PACK	A	B	KG. x1/WT.x1	VOL. x1/UNIT VOL.
110703-005	■ NERO/BLACK	x2	2	380	600	2,70	mc. 0,012
110704-002	■ GRIGIO/GRAY	x2	2	380	600	2,70	mc. 0,012
110710-001	■ CROMATO/CHROME	x2	2	380	600	2,70	mc. 0,012

08 90T(03) TRAVE PER PANCA 80x40								
90T(03) BEAM FOR BENCH 80x40								
CODICE/CODE	FINITURA/FINISHING	Q. KIT	Q. MIN/PACK	A	B	C	KG. x1/WT.x1	VOL. x1/UNIT VOL.
110703-190	■ NERO/BLACK 2 POSTI / 2 SEATS	x1	1	1160	80	40	3,20	mc. 0,0045
110704-090	■ GRIGIO/GREY 2 POSTI / 2 SEATS	x1	1	1160	80	40	3,20	mc. 0,0045
110703-191	■ NERO/BLACK 3 POSTI / 3 SEATS	x1	1	1710	80	40	4,71	mc. 0,005
110704-091	■ GRIGIO/GREY 3 POSTI / 3 SEATS	x1	1	1710	80	40	4,71	mc. 0,005
110703-192	■ NERO/BLACK 4 POSTI / 4 SEATS	x1	1	2260	80	40	6,22	mc. 0,0085
110704-092	■ GRIGIO/GREY 4 POSTI / 4 SEATS	x1	1	2260	80	40	6,22	mc. 0,0085
110703-193	■ NERO/BLACK 5 POSTI / 5 SEATS	x1	1	2800	80	40	7,72	mc. 0,01
110704-193	■ GRIGIO/GREY 5 POSTI / 5 SEATS	x1	1	2800	80	40	7,72	mc. 0,01

09 90CV-CAVALLOTTO SOTTOTRAVE							
90CV-SUPPORT UNDER BEAM							
CODICE/CODE	FINITURA/FINISHING	Q. KIT	Q. MIN/PACK	A	B	KG. x1/WT.x1	VOL. x1/UNIT VOL.
110703-007	■ NERO/BLACK	x1	50	55	65	0,60	mc. 0,0005
110704-016	■ GRIGIO/GRAY	x1	50	55	65	0,60	mc. 0,0005

10 VITE TESTA BOMBATA ESAGONO INCASSATO M6X14 ZINCATA							
SCREW M6X14 HEAD HEXAGON EMBEDDED ZINC							
CODICE/CODE	FINITURA/FINISHING	Q. KIT					
117711-185	■ ZINCATA/ZINC	x3					

11 VITE M8X12 TESTA CILINDRATA ESAGONO INCASSATO BRUNITA NERA							
SCREW M18X12 CILINDRICAL HEAD HEXAGON EMBEDDED BURNISHING BLACK							
CODICE/CODE	FINITURA/FINISHING	Q. KIT					
117703-239	■ NERO/BLACK	x4					

18 TAPPO COPRITESTA OVALE 40x20 TESTA CROMATA							
COVER HEAD 40x20 OVAL CHROME							
CODICE/CODE	FINITURA/FINISHING	Q. KIT					
134110-001	■ NERO/BLACK	x2					

19 TAPPO COPRITESTA D.20 TESTA CROMATA							
COVER HEAD D.20 CHROME							
CODICE/CODE	FINITURA/FINISHING	Q. KIT					
134110-200	■ NERO/BLACK	x2					

OPTIONAL GAMBA LEG OPTIONAL

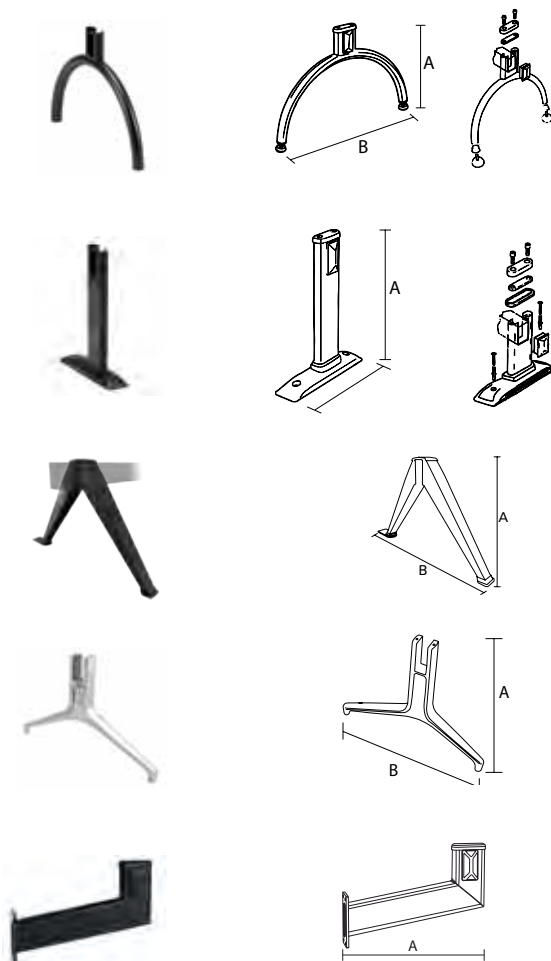

05 100GM-GAMBA MOBILE PER PANCA CON ACCESSORI 100GM-MOVABLE LEG FOR BENCH WITH ACCESSORIES

CODICE/CODE	FINITURA/FINISHING	Q. KIT	Q. MIN/PACK	A	B	KG.x1/WT.x1	VOL.x1/UNIT VOL.
110703-008	■ NERO/BLACK	x2	2	380	600	2,10	mc. 0,012
110704-004	■ GRIGIO/GRAY	x2	2	380	600	2,10	mc. 0,012
110710-005	■ CROMATO/CHROME	x2	2	380	600	2,10	mc. 0,012

06 90GF-GAMBA FISSA PER PANCA CON ACCESSORI 90GF-FIXED LEG FOR BENCH WITH ACCESSORIES

CODICE/CODE	FINITURA/FINISHING	Q. KIT	Q. MIN/PACK	A	B	KG.x1/WT.x1	VOL.x1/UNIT VOL.
110703-030	■ NERO/BLACK	x2	2	380	310	1,90	mc. 0,006
110704-011	■ GRIGIO/GRAY	x2	2	380	310	1,90	mc. 0,006

07 200GM-GAMBA MOBILE PER PANCA CON ACCESSORI 200GM-MOVABLE LEG FOR BENCH WITH ACCESSORIES

CODICE/CODE	FINITURA/FINISHING	Q. KIT	Q. MIN/PACK	A	B	KG.x1/WT.x1	VOL.x1/UNIT VOL.
110703-110	■ NERO/BLACK	x2	2	380	600	2,60	mc. 0,005
110704-112	■ GRIGIO/GRAY	x2	2	380	600	2,60	mc. 0,005
110710-110	■ CROMATO/CHROME	x2	2	380	600	2,60	mc. 0,005

12 SITON-GAMBA CORTA IN ALLUMINIO PER PANCA SITON-SHORT ALUMINIUM LEG FOR BENCH

CODICE/CODE	FINITURA/FINISHING	Q. KIT	Q. MIN/PACK	A	B	KG.x1/WT.x1	VOL.x1/UNIT VOL.
110704-170	■ ALLUMINIO/ALUMINIUM	x2	5	360	600	2,30	mc. 0,014

17 300GF-GAMBA FISSA PER PANCA CON ACCESSORI 300GF-FIXED LEG FOR BENCH WITH ACCESSORIES

CODICE/CODE	FINITURA/FINISHING	Q. KIT	Q. MIN/PACK	A	B	KG.x1/WT.x1	VOL.x1/UNIT VOL.
110703-107	■ NERO/BLACK	x2	2	390		1,45	mc. 0,012
110704-118	■ GRIGIO/GREY	x2	2	390		1,45	mc. 0,012

VERSIONE SITON
SITON VERSION

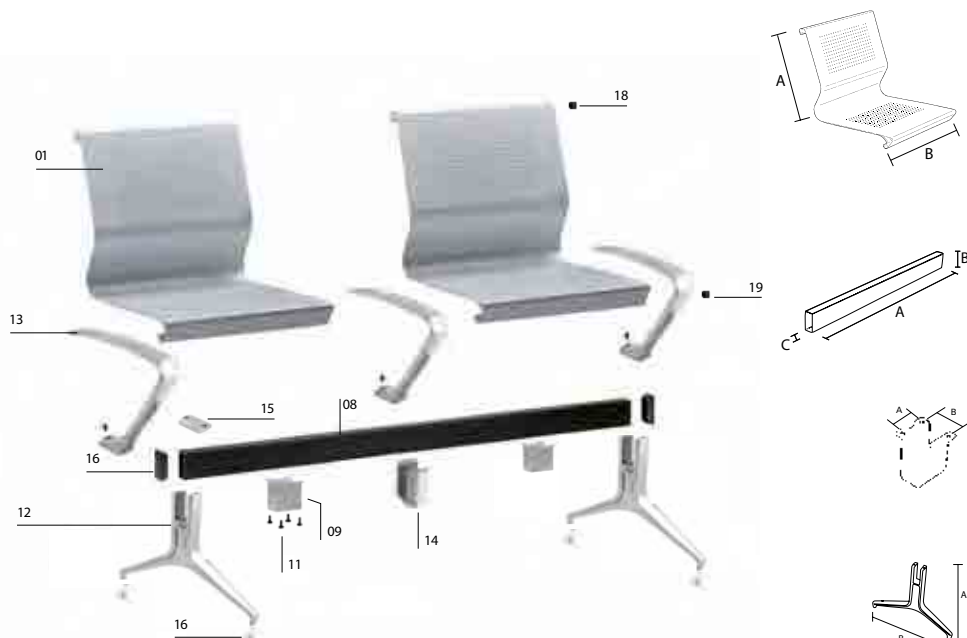

01 ARIA-SCocca INTERA IN LAMIERA ARIA-SHELL METAL SHEET									
CODICE/CODE	FINITURA/FINISHING	Q. KIT	Q. MIN/PACK	A	B	KG. x1/WT.x1	VOL. x1/UNIT VOL.		
110703-065	■ NERO/BLACK	x1	25	475	490	10,50	mc. 0,02		
110703-066	■ NERO/BLACK FORI X BRACC. / HOLES FOR ARMS	x1	25	475	490	10,50	mc. 0,02		
110704-025	■ GRIGIO/GRAY	x1	25	475	490	10,50	mc. 0,02		
110704-027	■ GRIGIO/GRAY FORI X BRACC. / HOLES FOR ARMS	x1	25	475	490	10,50	mc. 0,02		
08 90T(03) TRAVE PER PANCA 80x40 90T(03) BEAM FOR BENCH 80x40									
CODICE/CODE	FINITURA/FINISHING	Q. KIT	Q. MIN/PACK	A	B	C	KG. x1/WT.x1	VOL. x1/UNIT VOL.	
110703-190	■ NERO/BLACK 2 POSTI / 2 SEATS	x1	1	1160	80	40	3,20	mc. 0,0045	
110704-090	■ GRIGIO/GRAY 2 POSTI / 2 SEATS	x1	1	1160	80	40	3,20	mc. 0,0045	
110703-191	■ NERO/BLACK 3 POSTI / 3 SEATS	x1	1	1710	80	40	4,71	mc. 0,005	
110704-091	■ GRIGIO/GRAY 3 POSTI / 3 SEATS	x1	1	1710	80	40	4,71	mc. 0,005	
110703-192	■ NERO/BLACK 4 POSTI / 4 SEATS	x1	1	2260	80	40	6,22	mc. 0,0085	
110704-092	■ GRIGIO/GRAY 4 POSTI / 4 SEATS	x1	1	2260	80	40	6,22	mc. 0,0085	
110703-193	■ NERO/BLACK 5 POSTI / 5 SEATS	x1	1	2800	80	40	7,72	mc. 0,01	
110704-193	■ GRIGIO/GRAY 5 POSTI / 5 SEATS	x1	1	2800	80	40	7,72	mc. 0,01	
09 90CV-CAVALLOTTO SOTTOTRAVE 90CV-SUPPORT UNDER BEAM									
CODICE/CODE	FINITURA/FINISHING	Q. KIT	Q. MIN/PACK	A	B	KG. x1/WT.x1	VOL. x1/UNIT VOL.		
110703-007	■ NERO/BLACK	x1	50	55	65	0,60	mc. 0,0005		
110704-016	■ GRIGIO/GRAY	x1	50	55	65	0,60	mc. 0,0005		
11 VITE M8x12 TESTA CILINDRATA ESAGONO INCASSATO BRUNITA NERA SCREW M18x12 CILINDRICAL HEAD HEXAGON EMBEDDED BURNISHING BLACK									
CODICE/CODE	FINITURA/FINISHING	Q. KIT							
117703-239	■ NERO/BLACK	x4							
12 SITON-GAMBA CORTA IN ALLUMINIO PER PANCA SITON-SHORT ALUMINIUM LEG FOR BENCH									
CODICE/CODE	FINITURA/FINISHING	Q. KIT	Q. MIN/PACK	A	B	KG. x1/WT.x1	VOL. x1/UNIT VOL.		
110704-170	■ ALLUMINIO/ALUMINIUM	x2	5	360	600	2,30	mc. 0,014		
13 SITON-BRACCIOLO IN ALLUMINIO PER PANCA SITON-ALUMINIUM ARM FOR BENCH									
CODICE/CODE	FINITURA/FINISHING	Q. KIT	Q. MIN/PACK	A	B	KG. x1/WT.x1	VOL. x1/UNIT VOL.		
111704-030	■ ALLUMINIO/ALUMINIUM	x1	10	280	303	1,30	mc. 0,0011		
14 SITON-CAVALLOTTO IN ALLUMINIO 80x40 PER BRACCIOLO PANCA SITON-ALUMINIUM BRACKET 80x40 FOR BENCH ARM									
CODICE/CODE	FINITURA/FINISHING	Q. KIT	Q. MIN/PACK	KG. x1/WT.x1	VOL. x1/UNIT VOL.				
111704-031	■ ALLUMINIO/ALUMINIUM	x1	10	0,49	mc. 0,0012				
15 SITON-COPERCHIO IN ALLUMINIO PER GAMBA PANCA SITON-ALUMINIUM COVER FOR BENCH LEG									
CODICE/CODE	FINITURA/FINISHING	Q. KIT	Q. MIN/PACK	KG. x1/WT.x1	VOL. x1/UNIT VOL.				
110704-172	■ ALLUMINIO/ALUMINIUM	x2	10	0,11	mc. 0,0002				
16 SITON-KIT DI DIECI CONFEZIONI ACCESSORI SITON-TEN PACKS ACCESSORIES KIT FOR LEG BENCH									
CODICE/CODE	FINITURA/FINISHING	Q. KIT	Q. MIN/PACK	KG. x1/WT.x1	VOL. x1/UNIT VOL.				
137000-005	■ ALLUMINIO/ALUMINIUM	x1	10	0,85	mc. 0,004				
18 TAPPO COPRITESTA OVALE 40x20 TESTA CROMATA COVER HEAD 40x20 OVAL CHROME									
CODICE/CODE	FINITURA/FINISHING	Q. KIT							
134110-001	■ NERO/BLACK	x2							
19 TAPPO COPRITESTA D.20 TESTA CROMATA COVER HEAD D.20 CHROME									
CODICE/CODE	FINITURA/FINISHING	Q. KIT							
134110-200	■ NERO/BLACK	x2							

OPTIONAL GAMBA
LEG OPTIONAL







7th Avenue
Subway

L O O K

Exit

8th Avenue
Subway

A C E





LOOK



BENCH





278
LOOK

01	LOOK-SCOCCA IN FAGGIO VERNICIATO CON 4 BORCHIE LOOK-SHELL IN BEECH PAINT NATURAL WITH 4 IRON T-NUTS								
CODICE/CODE	FINITURA/FINISHING	Q. KIT	Q. MIN/PACK	A	B	C	KG. x1/WT.x1	VOL. x1/UNIT VOL.	
123907-010	■ FAGGIO/BEECH	x1	25	475	530	490	5,60	mc. 0,02	
123907-011	■ WENGÈ/WENGE	x1	25	475	530	490	5,60	mc. 0,02	
02	LOOK-PANNELLO SEDILE IN LEGNO DA TAPPEZZARE LOOK-PANEL SEAT IN WOOD FOR UPHOLSTERY WITH 4 IRON T-NUTS								
CODICE/CODE	FINITURA/FINISHING	Q. KIT	Q. MIN/PACK	A	B		KG. x1/WT.x1	VOL. x1/UNIT VOL.	
122207-035	■ GREZZO/RAW	x1	25	440	375		1,20	mc. 0,01	
03	92P-PIASTRA PER PANCA VERNICIATA 92P-PLATE FOR BENCH PAINT								
CODICE/CODE	FINITURA/FINISHING	Q. KIT	Q. MIN/PACK	A	B	C	D	KG. x1/WT.x1	VOL. x1/UNIT VOL.
110703-013	■ NERO/BLACK	x1	15	153	200	65	55	0,85	mc. 0,0002
04	90GM-GAMBA MOBILE PER PANCA CON ACCESSORI 90GM-MOVABLE LEG FOR BENCH WITH ACCESSORIES								
CODICE/CODE	FINITURA/FINISHING	Q. KIT	Q. MIN/PACK	A	B		KG. x1/WT.x1	VOL. x1/UNIT VOL.	
110703-005	■ NERO/BLACK	x2	2	380	600		2,70	mc. 0,012	
110704-002	■ GRIGIO/GRAY	x2	2	380	600		2,70	mc. 0,012	
110710-001	■ CROMATO/CHROME	x2	2	380	600		2,70	mc. 0,012	
09	90T(03) TRAVE PER PANCA 80x40 90T(03) BEAM FOR BENCH 80x40								
CODICE/CODE	FINITURA/FINISHING	Q. KIT	Q. MIN/PACK	A	B	C	KG. x1/WT.x1	VOL. x1/UNIT VOL.	
110703-190	■ NERO/BLACK 2 POSTI / 2 SEATS	x1	1	1160	80	40	3,20	mc. 0,0045	
110704-090	■ GRIGIO/GRAY 2 POSTI / 2 SEATS	x1	1	1160	80	40	3,20	mc. 0,0045	
110703-191	■ NERO/BLACK 3 POSTI / 3 SEATS	x1	1	1710	80	40	4,71	mc. 0,005	
110704-091	■ GRIGIO/GRAY 3 POSTI / 3 SEATS	x1	1	1710	80	40	4,71	mc. 0,005	
110703-192	■ NERO/BLACK 4 POSTI / 4 SEATS	x1	1	2260	80	40	6,22	mc. 0,0085	
110704-092	■ GRIGIO/GRAY 4 POSTI / 4 SEATS	x1	1	2260	80	40	6,22	mc. 0,0085	
110703-193	■ NERO/BLACK 5 POSTI / 5 SEATS	x1	1	2800	80	40	7,72	mc. 0,01	
110704-193	■ GRIGIO/GRAY 5 POSTI / 5 SEATS	x1	1	2800	80	40	7,72	mc. 0,01	
10	90CV-CAVALLOTTO SOTTOTRAVE 90CV-SUPPORT UNDER BEAM								
CODICE/CODE	FINITURA/FINISHING	Q. KIT	Q. MIN/PACK	A	B		KG. x1/WT.x1	VOL. x1/UNIT VOL.	
110703-007	■ NERO/BLACK	x1	50	55	65		0,60	mc. 0,0005	
110704-016	■ GRIGIO/GRAY	x1	50	55	65		0,60	mc. 0,0005	
11	VITE M8X12 TESTA CILINDRATA ESAGONO INCASSATO BRUNITA NERA SCREW M18X12 CILINDRICAL HEAD HEXAGON EMBEDDED BURNISHING BLACK								
CODICE/CODE	FINITURA/FINISHING	Q. KIT							
117703-239	■ NERO/BLACK	x4							

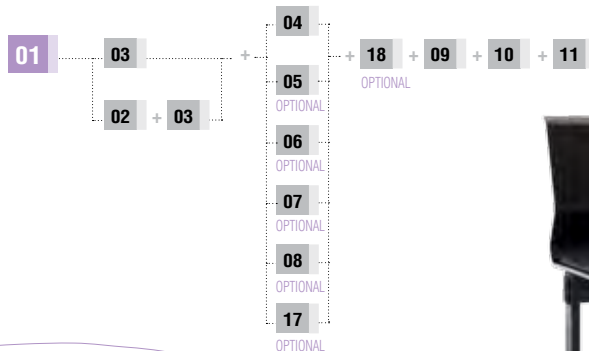

OPTIONAL GAMBA LEG OPTIONAL

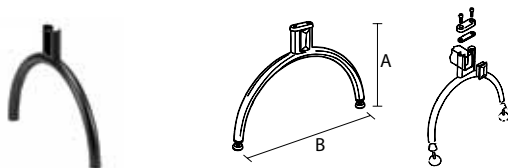

05 100GM-GAMBA MOBILE PER PANCA CON ACCESSORI 100GM-MOVABLE LEG FOR BENCH WITH ACCESSORIES							
CODICE/CODE	FINITURA/FINISHING	Q. KIT	Q. MIN/PACK	A	B	KG. x1/WT.x1	VOL. x1/UNIT VOL.
110703-008	■ NERO/BLACK	x2	2	380	600	2,10	mc. 0,012
110704-004	■ GRIGIO/GRAY	x2	2	380	600	2,10	mc. 0,012
110710-005	■ CROMATO/CHROME	x2	2	380	600	2,10	mc. 0,012

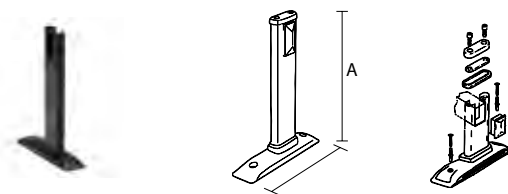

06 90GF-GAMBA FISSA PER PANCA CON ACCESSORI 90GF-FIXED LEG FOR BENCH WITH ACCESSORIES							
CODICE/CODE	FINITURA/FINISHING	Q. KIT	Q. MIN/PACK	A	B	KG. x1/WT.x1	VOL. x1/UNIT VOL.
110703-030	■ NERO/BLACK	x2	2	380	310	1,90	mc. 0,006
110704-011	■ GRIGIO/GRAY	x2	2	380	310	1,90	mc. 0,006



07 200GM-GAMBA MOBILE PER PANCA CON ACCESSORI 200GM-MOVABLE LEG FOR BENCH WITH ACCESSORIES							
CODICE/CODE	FINITURA/FINISHING	Q. KIT	Q. MIN/PACK	A	B	KG. x1/WT.x1	VOL. x1/UNIT VOL.
110703-110	■ NERO/BLACK	x2	4	380	600	2,60	mc. 0,005
110704-112	■ GRIGIO/GRAY	x2	4	380	600	2,60	mc. 0,005
110710-110	■ CROMATO/CHROME	x2	4	380	600	2,60	mc. 0,005

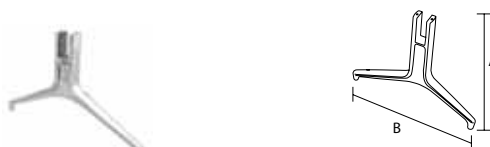

08 SITON-GAMBA CORTA IN ALLUMINIO PER PANCA SITON-SHORT ALUMINIUM LEG FOR BENCH							
CODICE/CODE	FINITURA/FINISHING	Q. KIT	Q. MIN/PACK	A	B	KG. x1/WT.x1	VOL. x1/UNIT VOL.
110704-170	■ ALLUMINIO/ALUMINIUM	x2	5	360	600	2,30	mc. 0,014



17 300GF-GAMBA FISSA PER PANCA CON ACCESSORI 300GF-FIXED LEG FOR BENCH WITH ACCESSORIES							
CODICE/CODE	FINITURA/FINISHING	Q. KIT	Q. MIN/PACK	A		KG. x1/WT.x1	VOL. x1/UNIT VOL.
110703-107	■ NERO/BLACK	x2	2	390		1,45	mc. 0,012
110704-118	■ GRIGIO/GREY	x2	2	390		1,45	mc. 0,012



18 PIONEER-BRACCIOLO ELLITTICO 40X20 PER PANCA CON ACCESSORI PIONEER-ELLIPTICAL 40X20 ARM FOR BENCH WITH ACCESSORIES							
CODICE/CODE	FINITURA/FINISHING	Q. KIT	Q. MIN/PACK	A		KG. x1/WT.x1	VOL. x1/UNIT VOL.
111703-015	■ NERO/BLACK	x1	5	260		1,10	mc. 0,005
111704-018	■ GRIGIO/GREY	x1	5	260		1,10	mc. 0,005
111710-015	■ CROMATO/CHROME	x1	5	260		1,10	mc. 0,005

VERSIONE SITON
SITON VERSION

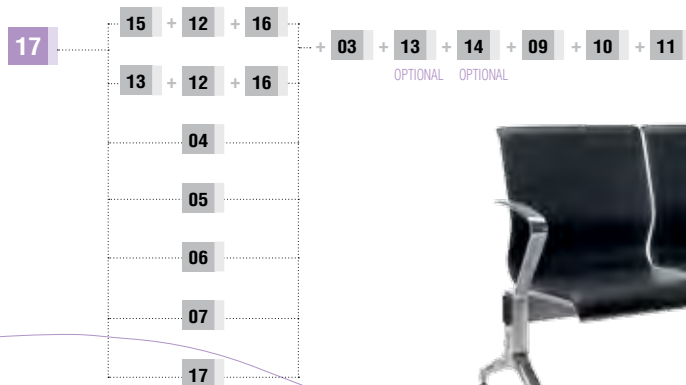
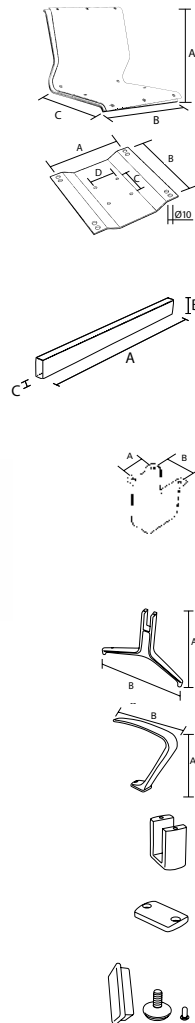
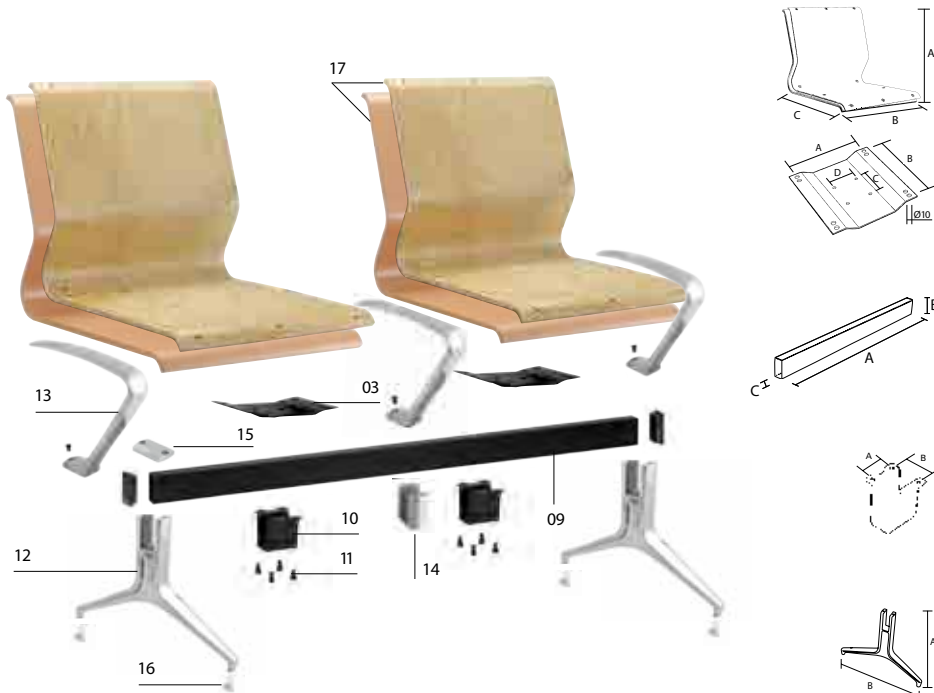

17	LOOK-SCocca IN FAGGIO VERNICIATO NATURALE CON 4 BORCHIE+CONTROSCocCA LOOK-SHELL IN BEECH PAINT NATURAL WITH 4 IRON T-NUTS+MONOSHELL FOR UPHOLSTERY	CODICE/CODE 123907-012	FINITURA/FINISHING ■ FAGGIO/BEECH	Q.KIT x1	Q.MIN/PACK 25	A 475	B 530	C 490	KG.x1/WT.x1 8,40	VOL.x1/UNIT VOL. mc. 0,04	
03	92P-PIASTRA PER PANCA VERNICIATA 92P-PLATE FOR BENCH PAINT	CODICE/CODE 110703-013	FINITURA/FINISHING ■ NERO/BLACK	Q.KIT x1	Q.MIN/PACK 15	A 153	B 200	C 65	D 55	KG.x1/WT.x1 0,85	VOL.x1/UNIT VOL. mc. 0,0002
09	90T(03) TRAVE PER PANCA 80x40 90T(03) BEAM FOR BENCH 80X40	CODICE/CODE 110703-190 110704-090 110703-191 110704-091 110703-192 110704-092 110703-193 110704-193	FINITURA/FINISHING ■ NERO/BLACK ■ GRIGIO/GREY ■ NERO/BLACK ■ GRIGIO/GREY ■ NERO/BLACK ■ GRIGIO/GREY ■ NERO/BLACK ■ GRIGIO/GREY	Q.KIT x1	Q.MIN/PACK 1	A 1160	B 80	C 40	KG.x1/WT.x1 3,20	VOL.x1/UNIT VOL. mc. 0,0045	
10	90CV-CAVALLOTTO SOTTOTRAVE 90CV-SUPPORT UNDER BEAM	CODICE/CODE 110703-007 110704-016	FINITURA/FINISHING ■ NERO/BLACK ■ GRIGIO/GRAY	Q.KIT x1	Q.MIN/PACK 50	A 55	B 65	KG.x1/WT.x1 0,60	VOL.x1/UNIT VOL. mc. 0,0005		
11	VITE M8X12 TESTA CILINDRATA ESAGONO INCASSATO BRUNITA NERA SCREW M18X12 CILINDRICAL HEAD HEXAGON EMBEDDED BURNISHING BLACK	CODICE/CODE 117703-239	FINITURA/FINISHING ■ NERO/BLACK	Q.KIT x4							
12	SITON-GAMBA CORTA IN ALLUMINIO PER PANCA SITON-SHORT ALUMINIUM LEG FOR BENCH	CODICE/CODE 110704-170	FINITURA/FINISHING ■ ALLUMINIO/ALUMINIUM	Q.KIT x2	Q.MIN/PACK 5	A 360	B 600	KG.x1/WT.x1 2,30	VOL.x1/UNIT VOL. mc. 0,014		
13	SITON-BRACCIOLO IN ALLUMINIO PER PANCA SITON-ALUMINIUM ARM FOR BENCH	CODICE/CODE 111704-030	FINITURA/FINISHING ■ ALLUMINIO/ALUMINIUM	Q.KIT x1	Q.MIN/PACK 10	A 280	B 303	KG.x1/WT.x1 1,30	VOL.x1/UNIT VOL. mc. 0,0011		
14	SITON-CAVALLOTTO IN ALLUMINIO 80x40 PER BRACCIOLO PANCA SITON-ALUMINIUM BRACKET 80X40 FOR BENCH ARM	CODICE/CODE 111704-031	FINITURA/FINISHING ■ ALLUMINIO/ALUMINIUM	Q.KIT x1	Q.MIN/PACK 10			KG.x1/WT.x1 0,49	VOL.x1/UNIT VOL. mc. 0,0012		
15	SITON-COPERCHIO IN ALLUMINIO PER GAMBA PANCA SITON-ALUMINIUM COVER FOR BENCH LEG	CODICE/CODE 110704-172	FINITURA/FINISHING ■ ALLUMINIO/ALUMINIUM	Q.KIT x2	Q.MIN/PACK 10			KG.x1/WT.x1 0,11	VOL.x1/UNIT VOL. mc. 0,0002		
16	SITON-KIT DI DIECI CONFEZIONI ACCESSORI SITON-TEN PACKS ACCESSORIES KIT FOR LEG BENCH	CODICE/CODE 137000-005	FINITURA/FINISHING ■ ALLUMINIO/ALUMINIUM	Q.KIT x1	Q.MIN/PACK 10			KG.x1/WT.x1 0,85	VOL.x1/UNIT VOL. mc. 0,004		

OPTIONAL GAMBA
LEG OPTIONAL





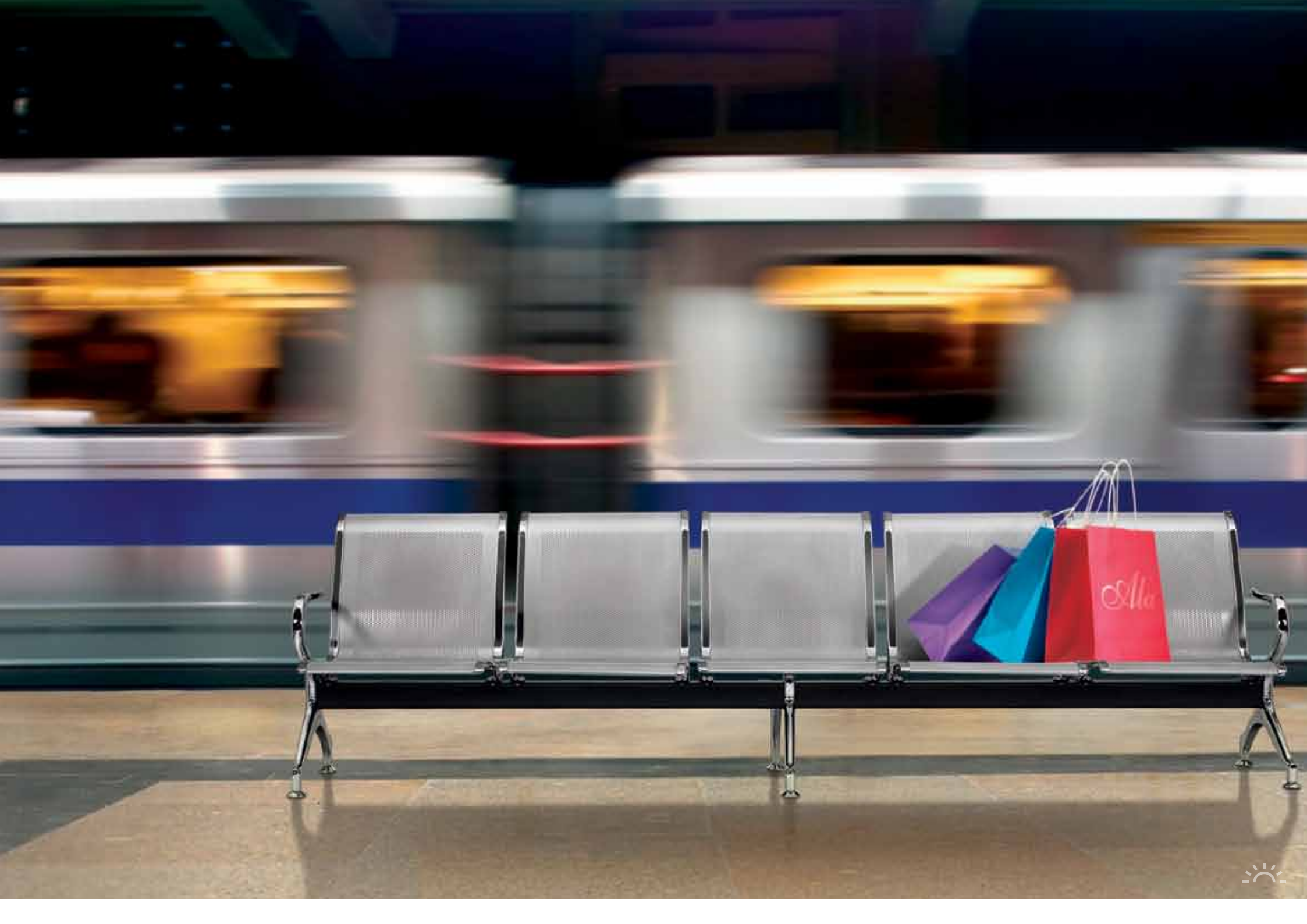

NON DISPONIBILE PER LA GERMANIA
NOT AVAILABLE FOR GERMANY



ALA



BENCH



LA PANCA VIENE FORNITA IN TUTTI I SUOI COMPONENTI SMONTATA
THE BENCH SUPPLIED WITH ALL ITS COMPONENTS NOT ASSEMBLED

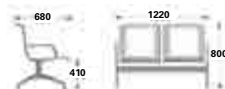

01 PANCA A DUE POSTI CON DUE BRACCIOLI BENCH TWO SEATS WITH TWO ARMS		Q. KIT	Q. MIN/PACK	KG. x1/WT.x1	VOL. x1/UNIT VOL.
CODICE/CODE	FINITURA/FINISHING				
110703-150	■ NERO/BLACK	x1	5	32,00	mc. 0,095
110704-150	■ GRIGIO/GRAY	x1	5	32,00	mc. 0,095
110702-150	■ BORDEAUX/BORDEAUX	x1	5	32,00	mc. 0,095

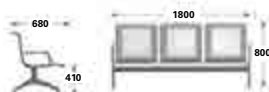

02 PANCA A TRE POSTI CON DUE BRACCIOLI BENCH THREE SEATS WITH TWO ARMS		Q. KIT	Q. MIN/PACK	KG. x1/WT.x1	VOL. x1/UNIT VOL.
CODICE/CODE	FINITURA/FINISHING				
110703-152	■ NERO/BLACK	x1	5	45,00	mc. 0,115
110704-152	■ GRIGIO/GRAY	x1	5	45,00	mc. 0,115
110702-152	■ BORDEAUX/BORDEAUX	x1	5	45,00	mc. 0,115

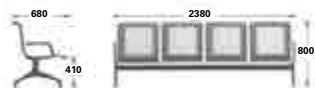

03 PANCA A QUATTRO POSTI CON DUE BRACCIOLI BENCH FOUR SEATS WITH TWO ARMS		Q. KIT	Q. MIN/PACK	KG. x1/WT.x1	VOL. x1/UNIT VOL.
CODICE/CODE	FINITURA/FINISHING				
110703-154	■ NERO/BLACK	x1	5	58,00	mc. 0,15
110704-154	■ GRIGIO/GRAY	x1	5	58,00	mc. 0,15
110702-154	■ BORDEAUX/BORDEAUX	x1	5	58,00	mc. 0,15

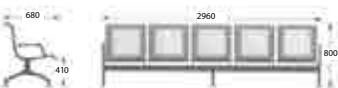

04 PANCA A CINQUE POSTI CON DUE BRACCIOLI BENCH FIVE SEATS WITH TWO ARMS		Q. KIT	Q. MIN/PACK	KG. x1/WT.x1	VOL. x1/UNIT VOL.
CODICE/CODE	FINITURA/FINISHING				
110703-156	■ NERO/BLACK	x1	5	72,00	mc. 0,17
110704-156	■ GRIGIO/GRAY	x1	5	72,00	mc. 0,17
110702-156	■ BORDEAUX/BORDEAUX	x1	5	72,00	mc. 0,17

BENCH OPTIONS:

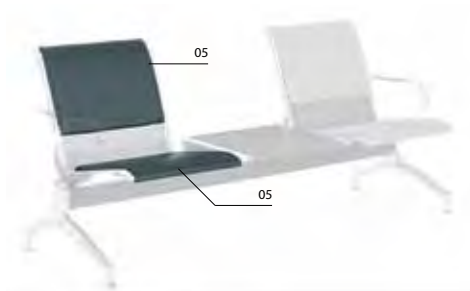

05 PANNELLO SEDILE E SCHIENALE TAPPEZZATO SIMILPELLE COMPLETO DI VITI					
PANEL SEAT AND BACK UPHOLSTER IMITATION LEATHERS WITH SCREWS					
CODICE/CODE	FINITURA/FINISHING	Q. KIT	Q. MIN/PACK	KG. x1/WT.x1	VOL. x1/UNIT VOL.
143903-001	■ NERO/BLACK	x1	5	2,30	mc. 0,008
143904-001	■ GRIGIO/GRAY	x1	5	2,30	mc. 0,008
143902-001	■ BORDEAUX/BORDEAUX	x1	5	2,30	mc. 0,008



06 TAVOLO PER PANCA IN LAMIERA COMPLETO DI VITI					
METAL SHEET TABLE FOR BENCH WITH SCREWS					
CODICE/CODE	FINITURA/FINISHING	Q. KIT	Q. MIN/PACK	KG. x1/WT.x1	VOL. x1/UNIT VOL.
110703-151	■ NERO/BLACK	x1	5	4,16	mc. 0,01
110704-151	■ GRIGIO/GRAY	x1	5	4,16	mc. 0,01
110702-151	■ BORDEAUX/BORDEAUX	x1	5	4,16	mc. 0,01





SITON



BENCH



SITON FOLDING BENCH

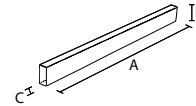
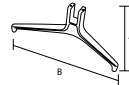
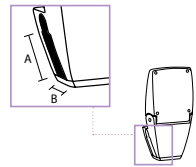

- 10 OPTIONAL
- 11 OPTIONAL
- 12 OPTIONAL

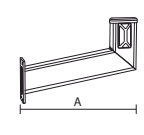
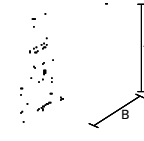
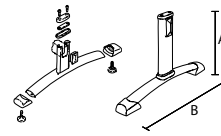

01 SITON-MECCANISMO PANCA RIBALTABILE ALLUMINIO LUCIDO SITON-POLISHED ALUMINIUM FOLDING MECHANISM							
CODICE/CODE	FINITURA/FINISHING	Q. KIT	Q. MIN/PACK	A	B	KG.x1/WT.x1	VOL.x1/UNIT VOL.
110704-180	■ ALLUMINIO/ALUMINIUM	x1	4	80	40	2,81	mc. 0,007

02 SITON-GAMBA LUNGA IN ALLUMINIO PER PANCA SITON-LONG ALLUMINIUM LEG FOR BENCH							
CODICE/CODE	FINITURA/FINISHING	Q. KIT	Q. MIN/PACK	A	B	KG.x1/WT.x1	VOL.x1/UNIT VOL.
110704-171	■ ALLUMINIO/ALUMINIUM	x2	5	305	643	2,80	mc. 0,014

03 SITON-BRACCIOLO IN ALLUMINIO PER PANCA SITON-ALUMINIUM ARM FOR BENCH							
CODICE/CODE	FINITURA/FINISHING	Q. KIT	Q. MIN/PACK	A	B	KG.x1/WT.x1	VOL.x1/UNIT VOL.
111704-030	■ ALLUMINIO/ALUMINIUM	x1	10	280	303	1,30	mc. 0,0011

04 90T(03) TRAVE PER PANCA 80x40 90T(03) BEAM FOR BENCH 80X40									
CODICE/CODE	FINITURA/FINISHING	Q. KIT	Q. MIN/PACK	A	B	C	KG.x1/WT.x1	VOL.x1/UNIT VOL.	
110703-190	■ NERO/BLACK	2 POSTI / 2 SEATS	x1	1	1160	80	40	3,20	mc. 0,0045
110704-190	■ GRIGIO/GREY	2 POSTI / 2 SEATS	x1	1	1160	80	40	3,20	mc. 0,0045
110703-191	■ NERO/BLACK	3 POSTI / 3 SEATS	x1	1	1710	80	40	4,71	mc. 0,005
110704-191	■ GRIGIO/GREY	3 POSTI / 3 SEATS	x1	1	1710	80	40	4,71	mc. 0,005
110703-192	■ NERO/BLACK	4 POSTI / 4 SEATS	x1	1	2260	80	40	6,22	mc. 0,0085
110704-192	■ GRIGIO/GREY	4 POSTI / 4 SEATS	x1	1	2260	80	40	6,22	mc. 0,0085
110703-193	■ NERO/BLACK	5 POSTI / 5 SEATS	x1	1	2800	80	40	7,72	mc. 0,01
110704-193	■ GRIGIO/GREY	5 POSTI / 5 SEATS	x1	1	2800	80	40	7,72	mc. 0,01

05 SITON-CAVALLOTTO IN ALLUMINIO 80x40 PER BRACCIOLO PANCA SITON-ALUMINIUM BRACKET 80X40 FOR BENCH ARM							
CODICE/CODE	FINITURA/FINISHING	Q. KIT	Q. MIN/PACK	KG.x1/WT.x1	VOL.x1/UNIT VOL.		
111704-031	■ ALLUMINIO/ALUMINIUM	x1	10	0,485	mc. 0,0012		

06 SITON-COPERCHIO IN ALLUMINIO PER GAMBA PANCA SITON-ALUMINIUM COVER FOR BENCH LEG							
CODICE/CODE	FINITURA/FINISHING	Q. KIT	Q. MIN/PACK	KG.x1/WT.x1	VOL.x1/UNIT VOL.		
110704-172	■ ALLUMINIO/ALUMINIUM	x2	10	0,113	mc. 0,0002		

07 SITON-KIT DI DIECI CONFEZIONI ACCESSORI PER GAMBA PANCA SITON-TEN PACKS ACCESSORIES KIT FOR LEG BENCH							
CODICE/CODE	FINITURA/FINISHING	Q. KIT	Q. MIN/PACK	KG.x1/WT.x1	VOL.x1/UNIT VOL.		
137000-005	■ ALLUMINIO/ALUMINIUM	x1	1	0,85	mc. 0,004		

08 SITON-SEDILE PER PANCA RIBALTABILE IN LEGNO VERNICIATO + 4 TESTINE E 4 VITI FISSAGGIO SITON-FOLDING BENCH SEAT, VARNISHED BEECHWOOD + 4 TUNES AND SCREWS FOR FIXING							
CODICE/CODE	FINITURA/FINISHING	Q. KIT	Q. MIN/PACK	A	B	KG.x1/WT.x1	VOL.x1/UNIT VOL.
122207-030	■ FAGGIO/BEECH	x1	10	420	400	1,40	mc. 0,01
122207-031	■ WENGÉ/WENGÉ	x1	10	420	400	1,40	mc. 0,01

09 SITON-SCHENALE PER PANCA RIBALTABILE IN LEGNO VERNICIATO + 4 VITI FISSAGGIO SITON-FOLDING BENCH BACK, VARNISHED BEECHWOOD + 4 TUNES AND SCREWS FOR FIXING							
CODICE/CODE	FINITURA/FINISHING	Q. KIT	Q. MIN/PACK	A	B	KG.x1/WT.x1	VOL.x1/UNIT VOL.
122107-030	■ FAGGIO/BEECH	x1	10	690	460	3,30	mc. 0,02
122107-031	■ WENGÉ/WENGÉ	x1	10	690	460	3,30	mc. 0,02

OPTIONAL GAMBA LEG OPTIONAL

10 90GM(02)-GAMBA MOBILE PER PANCA CON ACCESSORI 90GM(02)-MOVABLE LEG FOR BENCH WITH ACCESSORIES							
CODICE/CODE	FINITURA/FINISHING	Q. KIT	Q. MIN/PACK	A	B	KG.x1/WT.x1	VOL.x1/UNIT VOL.
110703-120	■ NERO/BLACK	x2	2	320	600	2,70	mc. 0,0012
110704-099	■ GRIGIO/GREY	x2	2	320	600	2,70	mc. 0,0012
110710-007	■ CROMATO/CHROME	x2	2	320	600	2,70	mc. 0,0012

11 90GF(02)-GAMBA FISSA PER PANCA CON ACCESSORI 90GF(02)-FIXED LEG FOR BENCH WITH ACCESSORIES							
CODICE/CODE	FINITURA/FINISHING	Q. KIT	Q. MIN/PACK	A	B	KG.x1/WT.x1	VOL.x1/UNIT VOL.
110703-122	■ NERO/BLACK	x2	2	320	310	1,80	mc. 0,0012
110704-107	■ GRIGIO/GREY	x2	2	320	310	1,80	mc. 0,0012

12 300GF(02)-GAMBA FISSA PER PANCA CON SEDUTA RIBALTABILE + ACCESSORI 300GF(02)-FIXED LEG FOR BENCH WITH FOLDING SEAT + ACCESSORIES							
CODICE/CODE	FINITURA/FINISHING	Q. KIT	Q. MIN/PACK	A	KG.x1/WT.x1	VOL.x1/UNIT VOL.	
110703-105	■ NERO/BLACK	x2	2	240	1,45	mc. 0,012	
110704-115	■ GRIGIO/GREY	x2	2	240	1,45	mc. 0,012	





NEW

ALBA  

+ COMPONENTS

SPOT

TAVOLI/TABLES

291
SPOT



spot

FOLLOW US ON

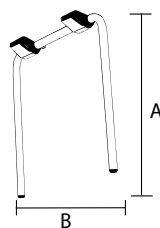
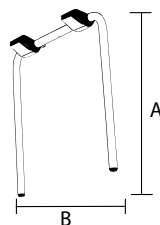
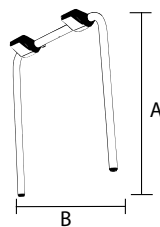

SPOT-GAMBA PIEGHEVOLE D.35 H.700 PER PIANO DA 800 CON ACCESSORI-SCATOLA DA DUE PEZZI - BREVETTATO

SPOT-LEG FOLDING D.35 H.700 TO PLAN FOR 800 WITH ACCESSORIES-TWO PIECES BOX - PATENTED

CODICE/CODE	FINITURA/FINISHING	Q. KIT	Q. MIN/PACK	A	B	KG. x1/WT.x1	VOL. x1/UNIT VOL.
110304-014	■ GRIGIO/GREY	x2	2	700	750	4,80	mc. 0,03
110305-014	□ BIANCO/WHITE	x2	2	700	750	4,80	mc. 0,03
110310-090	■ CROMATO/CHROME	x2	2	700	750	4,80	mc. 0,03

SPOT-GAMBA PIEGHEVOLE D.35 H.700 PER PIANO DA 700 CON ACCESSORI-SCATOLA DA DUE PEZZI - BREVETTATO

SPOT-LEG FOLDING D.35 H.700 TO PLAN FOR 700 WITH ACCESSORIES-TWO PIECES BOX - PATENTED

CODICE/CODE	FINITURA/FINISHING	Q. KIT	Q. MIN/PACK	A	B	KG. x1/WT.x1	VOL. x1/UNIT VOL.
110304-038	■ GRIGIO/GREY	x2	2	700	650	4,64	mc. 0,03
110305-013	□ BIANCO/WHITE	x2	2	700	650	4,64	mc. 0,03
110310-093	■ CROMATO/CHROME	x2	2	700	650	4,64	mc. 0,03

SPOT-GAMBA PIEGHEVOLE D.35 H.700 PER PIANO DA 600 CON ACCESSORI-SCATOLA DA DUE PEZZI - BREVETTATO

SPOT-LEG FOLDING D.35 H.700 TO PLAN FOR 600 WITH ACCESSORIES-TWO PIECES BOX - PATENTED

CODICE/CODE	FINITURA/FINISHING	Q. KIT	Q. MIN/PACK	A	B	KG. x1/WT.x1	VOL. x1/UNIT VOL.
110304-039	■ GRIGIO/GREY	x2	2	700	550	4,48	mc. 0,03
110305-039	□ BIANCO/WHITE	x2	2	700	550	4,48	mc. 0,03
110310-096	■ CROMATO/CHROME	x2	2	700	550	4,48	mc. 0,03

SPOT-COPPIA AGGANCI PER UNIONE PIANI TAVOLI IN PLASTICA+VITI

SPOT-PAIR OF PLASTIC HOOKS TO LINK THE TOP TABLES + SCREWS

CODICE/CODE	FINITURA/FINISHING	Q. KIT	Q. MIN/PACK	KG. x1/WT.x1
134003-136	■ NERO/BLACK	x1	10	0,0005

SPOT-CARRELLO PORTATAVOLI CON ACCESSORI

SPOT-TROLLEY FOR TABLES WITH ACCESSORIES

CODICE/CODE	FINITURA/FINISHING
110803-028	■ NERO/BLACK
110804-028	■ GRIGIO/GREY

6 SEMPLICI MOVIMENTI / 6 SIMPLE MOVEMENTS



01.



02.



03.



04.



05.



06.



spot





+ COMPONENTS



TAVOLI

TABLES

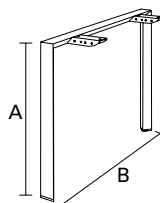

SHOCK-GAMBA TRIANGOLARE H.700 PER PIANO DA 800 CON ACCESSORI-SCATOLA DA DUE PEZZI

SHOCK-TRIANGULAR LEG H.700 FOR TOP 800 WITH ACCESSORIES - TWO BOX

CODICE/CODE	FINITURA/FINISHING	Q. KIT	Q. MIN/PACK	A	B	KG. x1/WT.x1	VOL. x1/UNIT VOL.
110304-001	■ GRIGIO/GREY	x2	2	700	800	5,50	mc. 0,03
110305-001	□ BIANCO/WHITE	x2	2	700	800	5,50	mc. 0,03
110310-080	■ CROMATO/CHROME	x2	2	700	800	5,50	mc. 0,03

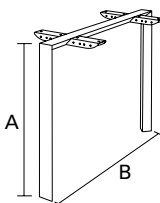

SHOCK-GAMBA TRIANGOLARE INTERMEDIA H.700 PER PIANO DA 800 CON ACCESSORI-SCATOLA DA DUE PEZZI

SHOCK-INTERMEDIATE TRIANGULAR LEG H.700 FOR TOP 800 WITH ACCESSORIES - TWO PIECES BOX

CODICE/CODE	FINITURA/FINISHING	Q. KIT	Q. MIN/PACK	A	B	KG. x1/WT.x1	VOL. x1/UNIT VOL.
110304-002	■ GRIGIO/GREY	x1	2	700	800	6,00	mc. 0,03
110305-002	□ BIANCO/WHITE	x1	2	700	800	6,00	mc. 0,03
110310-081	■ CROMATO/CHROME	x1	2	700	800	6,00	mc. 0,03



SHOCK-TRAVERSO PER TAVOLO TUBO RETTANGOLARE 50X30 VERNICIATO GRIGIO

SHOCK-BEAM FOR RECTANGULAR TABLE 50X30 GREY VARNISH

CODICE/CODE	FINITURA/FINISHING	Q. KIT	Q. MIN/PACK	LUNGHEZZA/LENGTH	KG. x1/WT.x1	VOL. x1/UNIT VOL.
110304-003	■ GRIGIO/GREY	x2	2	1064	2,60	mc. 0,002
110304-004	■ GRIGIO/GREY	x2	2	1264	3,00	mc. 0,003
110304-005	■ GRIGIO/GREY	x2	2	1464	3,50	mc. 0,004
110304-006	■ GRIGIO/GREY	x2	2	1664	3,95	mc. 0,005
110304-007	■ GRIGIO/GREY	x2	2	1864	4,40	mc. 0,006



SHOCK-STAFFA PER COMPOSIZIONE A L

SHOCK-BRACKET FOR L-SHAPE COMPOSITION

CODICE/CODE	FINITURA/FINISHING	Q. KIT	Q. MIN/PACK	KG. x1/WT.x1	VOL. x1/UNIT VOL.
110304-008	■ GRIGIO/GREY	x1	50	0,42	mc. 0,0005

TABLE - COMPOSITIONS WITH SHOCK LEG.

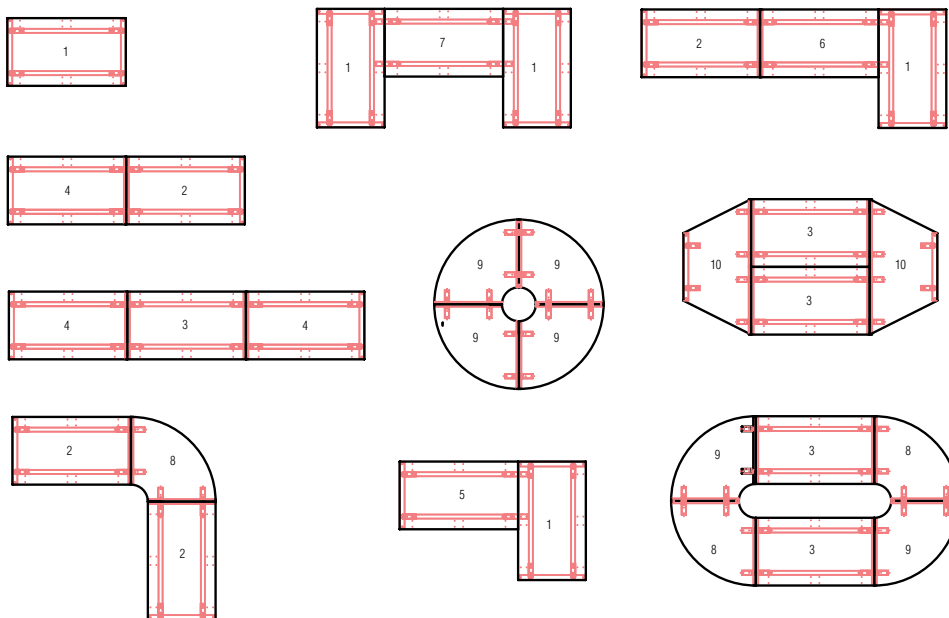

TABLES WITH TOPS

-1200x800
-1400x800
-1600x800
-1800x800
-2000x800

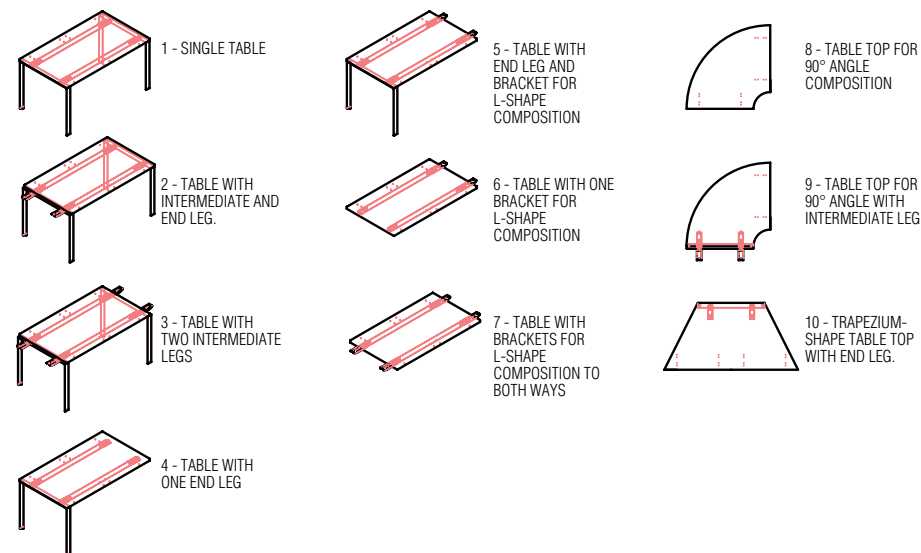



EXTRÒ-STRUTTURA IN ALLUMINIO PER TAVOLO RIBALTABILE CROMATO/VERNICIATO

EXTRÒ-CHROME/PAINTED TABLE TILTING MECHANISM IN ALLUMINIUM

CODICE/CODE	FINITURA/FINISHING	Q. KIT	Q. MIN/PACK	LUNGHEZZA/LENGTH	KG. x1/WT.x1	VOL. x1/UNIT VOL.
110310-101	■ CROMATO VERNICIATO/CHROME PAINTED	x1	1	1140	9,67	mc. 0,08
110310-102	■ CROMATO VERNICIATO/CHROME PAINTED	x1	1	1440	10,50	mc. 0,10
110310-103	■ CROMATO VERNICIATO/CHROME PAINTED	x1	1	1740	11,34	mc. 0,12

TOP NON DISPONIBILE

TOP NOT AVAILABLE

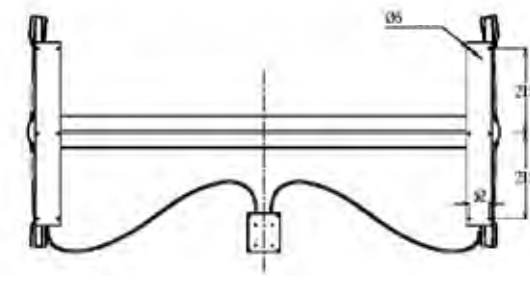
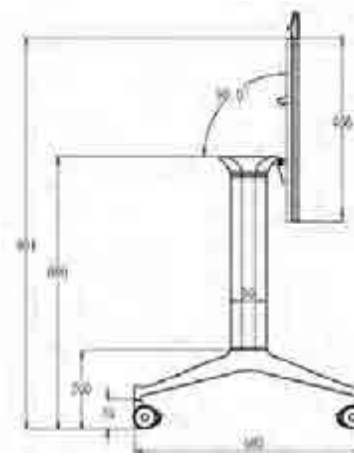
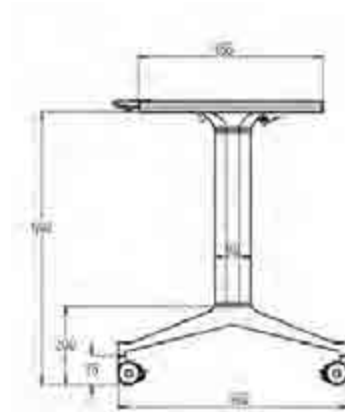
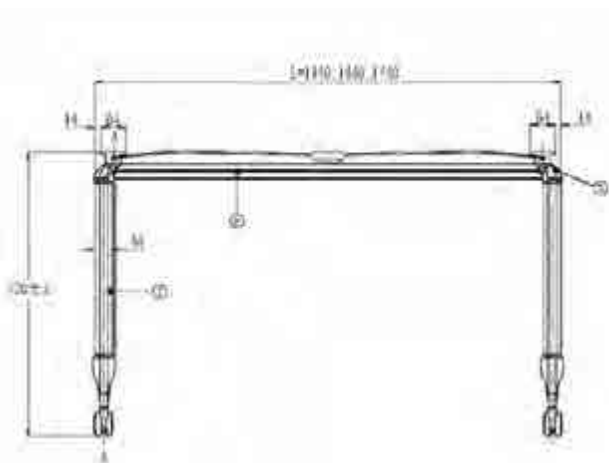





OFFICE
NEXT OPENING



+ COMPONENTS

OFFICE



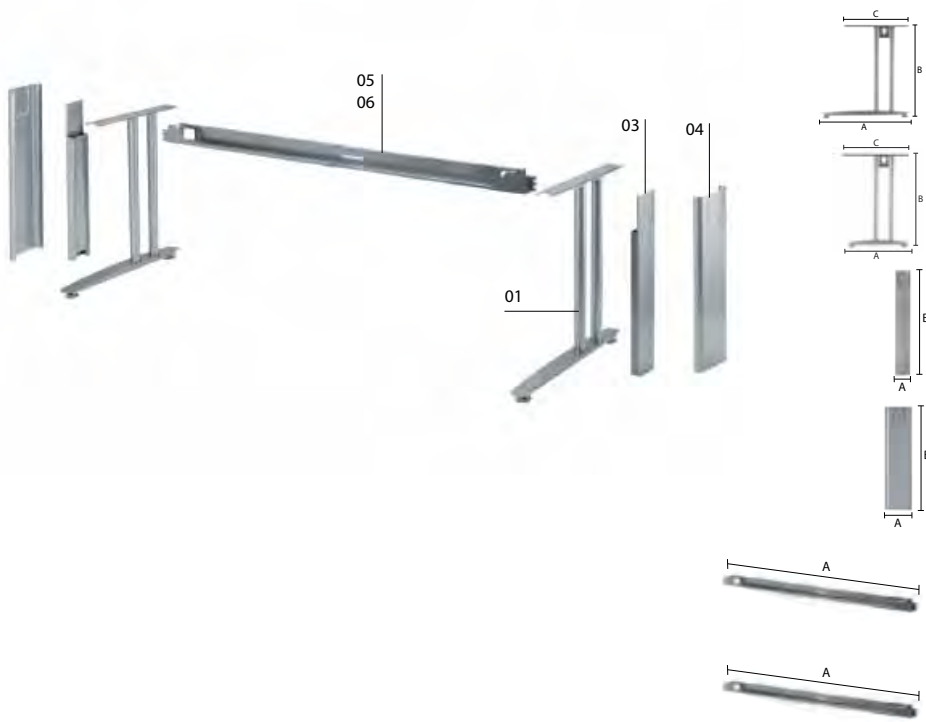

01 GS01-GAMBA FISSA CON PIATRINA AGGANCIAMENTO TRAVE METALLICA PER SCRIVANIA PROF. 800 GS01-FIXED LEG WITH METAL BEAM BRACKET, 800 MM DEEP DESK									
CODICE/CODE	FINITURA/FINISHING		Q. KIT	Q. MIN/PACK	A	B	C	KG. x1/WT.x1	VOL. x1/UNIT VOL.
110305-500	□ BIANCO/WHITE	RAL 9003	x2	50	700	695	480	4,00	mc. 0,05
110304-500	■ GRIGIO/GREY	RAL 9006	x2	50	700	695	480	4,00	mc. 0,05
110310-500	■ EFFETTO CROMATO/CHROME EFFECT		x2	50	700	695	480	4,00	mc. 0,05
02 GS02-GAMBA FISSA CON PIATRINA AGGANCIAMENTO TRAVE METALLICA PER SCRIVANIA PROF. 600 GS02-FIXED LEG WITH METAL BEAM BRACKET, 600 MM DEEP DESK									
CODICE/CODE	FINITURA/FINISHING		Q. KIT	Q. MIN/PACK	A	B	C	KG. x1/WT.x1	VOL. x1/UNIT VOL.
110305-505	□ BIANCO/WHITE	RAL 9003	x2	60	550	695	480	3,50	mc. 0,04
110304-505	■ GRIGIO/GREY	RAL 9006	x2	60	550	695	480	3,50	mc. 0,04
110310-505	■ EFFETTO CROMATO/CHROME EFFECT		x2	60	550	695	480	3,50	mc. 0,04
03 CI01-CARTER INTERNO PER GAMBA FISSA CI01-INSIDE TUBES CARTER FOR FIXED LEG									
CODICE/CODE	FINITURA/FINISHING		Q. KIT	Q. MIN/PACK	A	B		KG. x1/WT.x1	VOL. x1/UNIT VOL.
110305-600	□ BIANCO/WHITE	RAL 9003	x2	50	95	630		1,00	mc. 0,004
110304-600	■ GRIGIO/GREY	RAL 9006	x2	50	95	630		1,00	mc. 0,004
110310-600	■ EFFETTO CROMATO/CHROME EFFECT		x2	50	95	630		1,00	mc. 0,004
04 CE01-CARTER ESTERNO PER GAMBA FISSA CE01-OUTSIDE TUBES CARTER FOR FIXED LEG									
CODICE/CODE	FINITURA/FINISHING		Q. KIT	Q. MIN/PACK	A	B		KG. x1/WT.x1	VOL. x1/UNIT VOL.
110305-601	□ BIANCO/WHITE	RAL 9003	x2	50	164	630		1,50	mc. 0,007
110304-601	■ GRIGIO/GREY	RAL 9006	x2	50	164	630		1,50	mc. 0,007
110310-601	■ EFFETTO CROMATO/CHROME EFFECT		x2	50	164	630		1,50	mc. 0,007
05 TCS01-TRAVE DI COLLEGAMENTO TELESCOPICA PER SCRIVANIE CON PIANI L 800/1000 TCS01-TELESCOPIC CONNECTION BEAM FOR TOPS FROM 800 TO 1000 MM									
CODICE/CODE	FINITURA/FINISHING		Q. KIT	Q. MIN/PACK	A			KG. x1/WT.x1	VOL. x1/UNIT VOL.
110305-580	□ BIANCO/WHITE	RAL 9003	x1	50	660/860			3,00	mc. 0,007
110304-580	■ GRIGIO/GREY	RAL 9006	x1	50	660/860			3,00	mc. 0,007
110310-580	■ EFFETTO CROMATO/CHROME EFFECT		x1	50	660/860			3,00	mc. 0,007
06 TCS02-TRAVE DI COLLEGAMENTO TELESCOPICA PER SCRIVANIE CON PIANI L 1200/1800 TCS02-TELESCOPIC CONNECTION BEAM FOR TOPS FROM 1200 TO 1800 MM									
CODICE/CODE	FINITURA/FINISHING		Q. KIT	Q. MIN/PACK	A			KG. x1/WT.x1	VOL. x1/UNIT VOL.
110305-581	□ BIANCO/WHITE	RAL 9003	x1	50	1060/1660			5,00	mc. 0,01
110304-581	■ GRIGIO/GREY	RAL 9006	x1	50	1060/1660			5,00	mc. 0,01
110310-581	■ EFFETTO CROMATO/CHROME EFFECT		x1	50	1060/1660			5,00	mc. 0,01

302

OFFICE

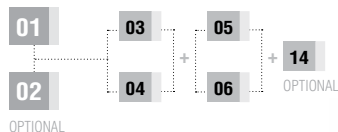

OPTIONAL 02

GS02-GAMBA FISSA PER SCRIVANIA PROF. 600
GS02-FIXED LEG FOR 600 MM DEEP DESK



01+03



01+04



14 GS07-GAMBA A COLONNA D.80 PER ANGOLI A 90°
GS07-COLUMN LEG D.80 FOR ANGLES OF 90°

CODICE/CODE	FINITURA/FINISHING		Q.KIT	Q.MIN/PACK	A	B	KG.x1/WT.x1	VOL.x1/UNIT VOL.
110305-530	□ BIANCO/WHITE	RAL 9003	x1	25	695	120x120	4,00	mc. 0,05
110304-530	■ GRIGIO/GREY	RAL 9006	x1	25	695	120x120	4,00	mc. 0,05
110310-530	■ EFFETTO CROMATO/CHROME EFFECT		x1	25	695	120x120	4,00	mc. 0,05



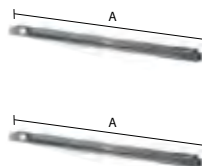
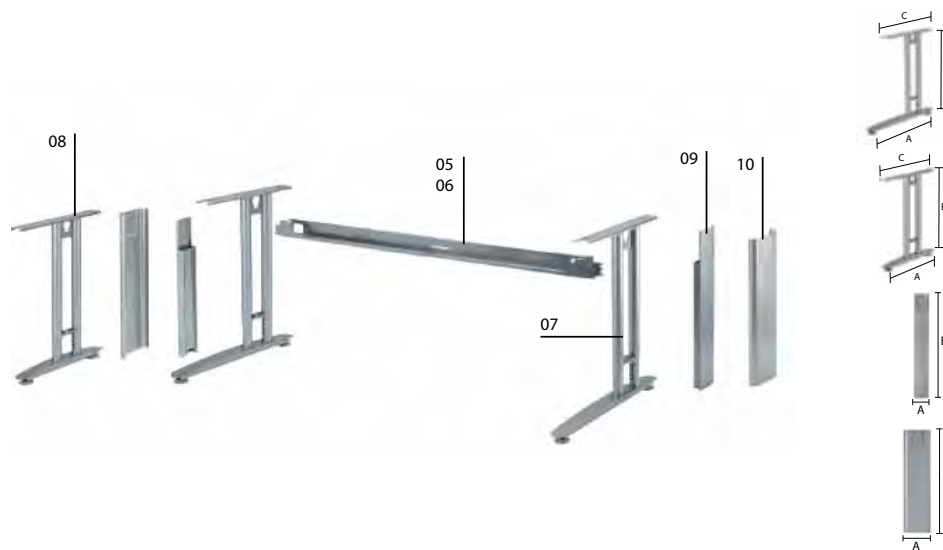

07 GS03-GAMBA REGOLABILE CON PIATRINA AGGANCIAMENTO TRAVE METALLICA PER SCRIVANIA PROF. 800
GS03-HIGH ADJUSTABLE LEG WITH METAL BEAM BRACKET, 800 MM DEEP DESK

CODICE/CODE	FINITURA/FINISHING	Q. KIT	Q. MIN/PACK	A	B	C	KG. x1/WT.x1	VOL. x1/UNIT VOL.
110305-510	□ BIANCO/WHITE RAL 9003	x2	50	700	590-790	480	5,50	mc. 0,05
110304-510	■ GRIGIO/GREY RAL 9006	x2	50	700	590-790	480	5,50	mc. 0,05
110310-510	■ EFFETTO CROMATO/CHROME EFFECT	x2	50	700	590-790	480	5,50	mc. 0,05

08 GS04-GAMBA REGOLABILE CON PIATRINA AGGANCIAMENTO TRAVE METALLICA PER SCRIVANIA PROF. 600
GS04-HIGH ADJUSTABLE LEG WITH METAL BEAM BRACKET, 600 MM DEEP DESK

CODICE/CODE	FINITURA/FINISHING	Q. KIT	Q. MIN/PACK	A	B	C	KG. x1/WT.x1	VOL. x1/UNIT VOL.
110305-515	□ BIANCO/WHITE RAL 9003	x2	60	550	590-790	480	5,00	mc. 0,05
110304-515	■ GRIGIO/GREY RAL 9006	x2	60	550	590-790	480	5,00	mc. 0,05
110310-515	■ EFFETTO CROMATO/CHROME EFFECT	x2	60	550	590-790	480	5,00	mc. 0,05

09 CI02-CARTER INTERNO PER GAMBA REGOLABILE
CI02-INSIDE TUBES CARTER FOR HIGH ADJUSTABLE LEG

CODICE/CODE	FINITURA/FINISHING	Q. KIT	Q. MIN/PACK	A	B	KG. x1/WT.x1	VOL. x1/UNIT VOL.
110305-602	□ BIANCO/WHITE RAL 9003	x2	50	95	525	1,00	mc. 0,004
110304-602	■ GRIGIO/GREY RAL 9006	x2	50	95	525	1,00	mc. 0,004
110310-602	■ EFFETTO CROMATO/CHROME EFFECT	x2	50	95	525	1,00	mc. 0,004

10 CE02-CARTER ESTERNO PER GAMBA REGOLABILE
CE02-OUTSIDE TUBES CARTER FOR HIGH ADJUSTABLE LEG

CODICE/CODE	FINITURA/FINISHING	Q. KIT	Q. MIN/PACK	A	B	KG. x1/WT.x1	VOL. x1/UNIT VOL.
110305-603	□ BIANCO/WHITE RAL 9003	x2	50	164	525	1,50	mc. 0,007
110304-603	■ GRIGIO/GREY RAL 9006	x2	50	164	525	1,50	mc. 0,007
110310-603	■ EFFETTO CROMATO/CHROME EFFECT	x2	50	164	525	1,50	mc. 0,007

05 TCS01-TRAVE DI COLLEGAMENTO TELESCOPICA PER SCRIVANIE CON PIANI L 800/1000
TCS01-TELESCOPIC CONNECTION BEAM FOR TOPS FROM 800 TO 1000 MM

CODICE/CODE	FINITURA/FINISHING	Q. KIT	Q. MIN/PACK	A	KG. x1/WT.x1	VOL. x1/UNIT VOL.
110305-580	□ BIANCO/WHITE RAL 9003	x1	50	660/860	3,00	mc. 0,007
110304-580	■ GRIGIO/GREY RAL 9006	x1	50	660/860	3,00	mc. 0,007
110310-580	■ EFFETTO CROMATO/CHROME EFFECT	x1	50	660/860	3,00	mc. 0,007

06 TCS02-TRAVE DI COLLEGAMENTO TELESCOPICA PER SCRIVANIE CON PIANI L 1200/1800
TCS02-TELESCOPIC CONNECTION BEAM FOR TOPS FROM 1200 TO 1800 MM

CODICE/CODE	FINITURA/FINISHING	Q. KIT	Q. MIN/PACK	A	KG. x1/WT.x1	VOL. x1/UNIT VOL.
110305-581	□ BIANCO/WHITE RAL 9003	x1	50	1060/1660	5,00	mc. 0,01
110304-581	■ GRIGIO/GREY RAL 9006	x1	50	1060/1660	5,00	mc. 0,01
110310-581	■ EFFETTO CROMATO/CHROME EFFECT	x1	50	1060/1660	5,00	mc. 0,01

OPTIONAL 08

GS04-GAMBA REGOLABILE PER SCRIVANIA PROF. 600
GS04-HIGH ADJUSTABLE LEG FOR 600 MM DEEP DESK

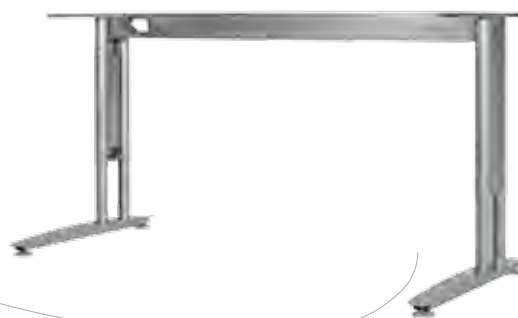
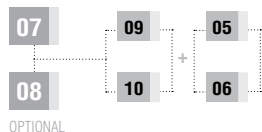

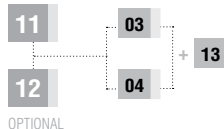
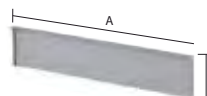
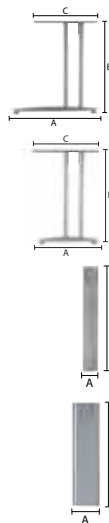

11 GS05-GAMBA FISSA CON FORI FILETTATI PER AGGANCIAMENTO MODESTY PANEL PER SCRIVANIA PROF. 800

GS05-FIXED LEG WITH THREADED HOLES FOR MODESTY PANEL, 800 MM DEEP DESK

CODICE/CODE	FINITURA/FINISHING	RAL	Q. KIT	Q. MIN/PACK	A	B	C	KG. x1/WT.x1	VOL. x1/UNIT VOL.
110305-520	□ BIANCO/WHITE	RAL 9003	x2	50	700	695	480	4,00	mc. 0,05
110304-520	■ GRIGIO/GREY	RAL 9006	x2	50	700	695	480	4,00	mc. 0,05
110310-520	■ EFFETTO CROMATO/CHROME EFFECT		x2	50	700	695	480	4,00	mc. 0,05

12 GS06-GAMBA FISSA CON FORI FILETTATI PER AGGANCIAMENTO MODESTY PANEL PER SCRIV. PROF. 600

GS06-FIXED LEG WITH THREADED HOLES FOR MODESTY PANEL, 600 MM DEEP DESK

CODICE/CODE	FINITURA/FINISHING	RAL	Q. KIT	Q. MIN/PACK	A	B	C	KG. x1/WT.x1	VOL. x1/UNIT VOL.
110305-525	□ BIANCO/WHITE	RAL 9003	x2	60	550	695	480	3,50	mc. 0,04
110304-525	■ GRIGIO/GREY	RAL 9006	x2	60	550	695	480	3,50	mc. 0,04
110310-525	■ EFFETTO CROMATO/CHROME EFFECT		x2	60	550	695	480	3,50	mc. 0,04

03 C101-CARTER INTERNO PER GAMBA FISSA

C101-INSIDE TUBES CARTER FOR FIXED LEG

CODICE/CODE	FINITURA/FINISHING	RAL	Q. KIT	Q. MIN/PACK	A	B	KG. x1/WT.x1	VOL. x1/UNIT VOL.
110305-600	□ BIANCO/WHITE	RAL 9003	x2	50	95	630	1,00	mc. 0,004
110304-600	■ GRIGIO/GREY	RAL 9006	x2	50	95	630	1,00	mc. 0,004
110310-600	■ EFFETTO CROMATO/CHROME EFFECT		x2	50	95	630	1,00	mc. 0,004

04 CE01-CARTER ESTERNO PER GAMBA FISSA

CE01-OUTSIDE TUBES CARTER FOR FIXED LEG

CODICE/CODE	FINITURA/FINISHING	RAL	Q. KIT	Q. MIN/PACK	A	B	KG. x1/WT.x1	VOL. x1/UNIT VOL.
110305-601	□ BIANCO/WHITE	RAL 9003	x2	50	164	630	1,50	mc. 0,007
110304-601	■ GRIGIO/GREY	RAL 9006	x2	50	164	630	1,50	mc. 0,007
110310-601	■ EFFETTO CROMATO/CHROME EFFECT		x2	50	164	630	1,50	mc. 0,007

13 MP-MODESTY PANEL IN METALLO

MP-METAL MODESTY PANEL

CODICE/CODE	FINITURA/FINISHING	RAL	Q. KIT	Q. MIN/PACK	A	B	KG. x1/WT.x1	VOL. x1/UNIT VOL.
110305-650	□ BIANCO/WHITE	RAL 9003	x1	50	800	300	3,00	mc. 0,007
110304-650	■ GRIGIO/GREY	RAL 9006	x1	50	800	300	3,00	mc. 0,007
110310-650	■ EFFETTO CROMATO/CHROME EFFECT		x1	50	800	300	3,00	mc. 0,007
110305-651	□ BIANCO/WHITE	RAL 9003	x1	50	1000	300	3,50	mc. 0,009
110304-651	■ GRIGIO/GREY	RAL 9006	x1	50	1000	300	3,50	mc. 0,009
110310-651	■ EFFETTO CROMATO/CHROME EFFECT		x1	50	1000	300	3,00	mc. 0,009
110305-652	□ BIANCO/WHITE	RAL 9003	x1	50	1200	300	4,00	mc. 0,011
110304-652	■ GRIGIO/GREY	RAL 9006	x1	50	1200	300	4,00	mc. 0,011
110310-652	■ EFFETTO CROMATO/CHROME EFFECT		x1	50	1200	300	4,00	mc. 0,011
110305-653	□ BIANCO/WHITE	RAL 9003	x1	50	1400	300	4,50	mc. 0,013
110304-653	■ GRIGIO/GREY	RAL 9006	x1	50	1400	300	4,50	mc. 0,013
110310-653	■ EFFETTO CROMATO/CHROME EFFECT		x1	50	1400	300	4,50	mc. 0,013
110305-654	□ BIANCO/WHITE	RAL 9003	x1	50	1600	300	5,00	mc. 0,015
110304-654	■ GRIGIO/GREY	RAL 9006	x1	50	1600	300	5,00	mc. 0,015
110310-654	■ EFFETTO CROMATO/CHROME EFFECT		x1	50	1600	300	5,00	mc. 0,015
110305-655	□ BIANCO/WHITE	RAL 9003	x1	50	1800	300	5,50	mc. 0,017
110304-655	■ GRIGIO/GREY	RAL 9006	x1	50	1800	300	5,50	mc. 0,017
110310-655	■ EFFETTO CROMATO/CHROME EFFECT		x1	50	1800	300	5,50	mc. 0,017

OPTIONAL 12

GS06-GAMBA FISSA CON FORI FILETTATI PER SCRIVANIA PROF. 600
GS06-FIXED LEG WITH THREADED HOLES FOR 600 MM DEEP DESK







APPENDIABITI E COMPLEMENTI DI ARREDO



COAT HANGERS AND FURNISHING ACCESSORIES

APPENDIABILI/COAT HANGERS COMPONENTS

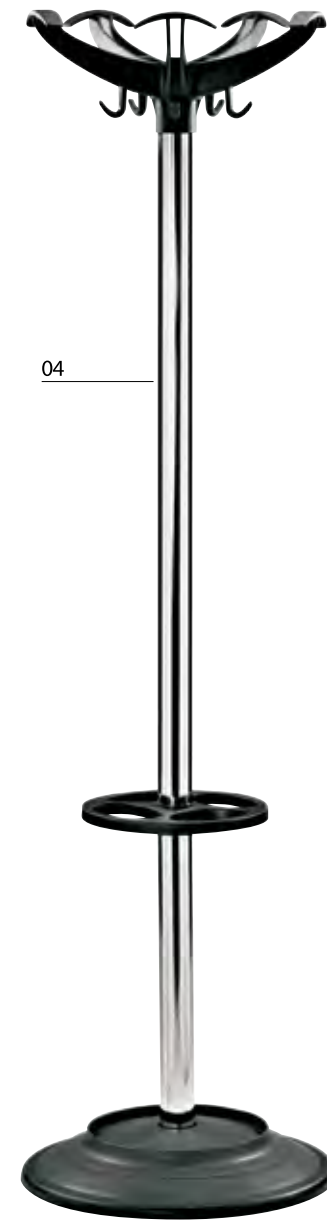

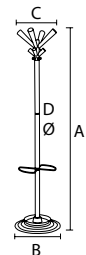

01 JOY-APPENDIABITO A COLONNA CON PORTAOMBRELLI COMPONENTI IN PLASTICA										
JOY-COAT HANGER WITH UMBRELLA STAND PLASTIC COMPONENTS ASSEMBLED										
CODICE/CODE	FINITURA/FINISHING	PLASTICA/PLASTIC	Q. KIT	Q. MIN/PACK	A	B	C	D	KG.x1/WT.x1	VOL.x1/UNIT VOL.
110404-100	■ GRIGIO/GREY	□ TRANSPARENT	x1	50	1750	415	380	40	8,65	mc. 0,039
110404-101	■ GRIGIO/GREY	■ ORANGE TRANSPARENT	x1	50	1750	415	380	40	8,65	mc. 0,039
110404-102	■ GRIGIO/GREY	■ FUME' TRANSPARENT	x1	50	1750	415	380	40	8,65	mc. 0,039
110405-100	□ BIANCO/WHITE	□ TRANSPARENT	x1	50	1750	415	380	40	8,65	mc. 0,039
110405-101	□ BIANCO/WHITE	■ ORANGE TRANSPARENT	x1	50	1750	415	380	40	8,65	mc. 0,039
110405-102	□ BIANCO/WHITE	■ FUME' TRANSPARENT	x1	50	1750	415	380	40	8,65	mc. 0,039

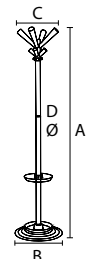

02 EASY-APPENDIABITO A COLONNA CON VASSOIO PORTAOGGETTI COMPONENTI IN PLASTICA										
EASY-COAT HANGER WITH MULTIPURPOSE TRAY PLASTIC COMPONENTS ASSEMBLED										
CODICE/CODE	FINITURA/FINISHING	PLASTICA/PLASTIC	Q. KIT	Q. MIN/PACK	A	B	C	D	KG.x1/WT.x1	VOL.x1/UNIT VOL.
110404-106	■ GRIGIO/GREY	□ TRANSPARENT	x1	50	1750	415	380	40	8,20	mc. 0,039
110404-107	■ GRIGIO/GREY	■ ORANGE TRANSPARENT	x1	50	1750	415	380	40	8,20	mc. 0,039
110404-108	■ GRIGIO/GREY	■ FUME' TRANSPARENT	x1	50	1750	415	380	40	8,20	mc. 0,039
110405-106	□ BIANCO/WHITE	□ TRANSPARENT	x1	50	1750	415	380	40	8,20	mc. 0,039
110405-107	□ BIANCO/WHITE	■ ORANGE TRANSPARENT	x1	50	1750	415	380	40	8,20	mc. 0,039
110405-108	□ BIANCO/WHITE	■ FUME' TRANSPARENT	x1	50	1750	415	380	40	8,20	mc. 0,039

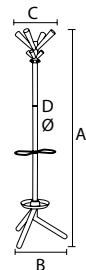

03 VIP-APPENDIABITO A COLONNA CON PORTAOMBRELLI COMPONENTI IN PLASTICA										
VIP-COAT HANGER WITH UMBRELLA STAND PLASTIC COMPONENTS ASSEMBLED										
CODICE/CODE	FINITURA/FINISHING	PLASTICA/PLASTIC	Q. KIT	Q. MIN/PACK	A	B	C	D	KG.x1/WT.x1	VOL.x1/UNIT VOL.
110404-103	■ GRIGIO/GREY	□ TRANSPARENT	x1	25	1750	600	380	40	5,50	mc. 0,09
110404-104	■ GRIGIO/GREY	■ ORANGE TRANSPARENT	x1	25	1750	600	380	40	5,50	mc. 0,09
110404-105	■ GRIGIO/GREY	■ FUME' TRANSPARENT	x1	25	1750	600	380	40	5,50	mc. 0,09
110405-103	□ BIANCO/WHITE	□ TRANSPARENT	x1	25	1750	600	380	40	5,50	mc. 0,09
110405-104	□ BIANCO/WHITE	■ ORANGE TRANSPARENT	x1	25	1750	600	380	40	5,50	mc. 0,09
110405-105	□ BIANCO/WHITE	■ FUME' TRANSPARENT	x1	25	1750	600	380	40	5,50	mc. 0,09

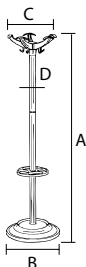

04 ELIX-APPENDIABITO A COLONNA CON PORTAOMBRELLI, COMPONENTI IN PLASTICA NERI ASSEMBLATI										
ELIX-COAT HANGER WITH UMBRELLA STAND, PLASTIC COMPONENTS ASSEMBLED BLACK										
CODICE/CODE	FINITURA/FINISHING	PLASTICA/PLASTIC	Q. KIT	Q. MIN/PACK	A	B	C	D	KG.x1/WT.x1	VOL.x1/UNIT VOL.
110403-040	■ NERO/BLACK	■ NERO/BLACK	x1	60	1730	450	400	50	5,00	mc. 0,045
110404-006	■ GRIGIO/GREY	■ NERO/BLACK	x1	60	1730	450	400	50	5,00	mc. 0,045
110405-015	□ BIANCO/WHITE	■ NERO/BLACK	x1	60	1730	450	400	50	5,00	mc. 0,045
110410-040	■ CROMATO/CHROME	■ NERO/BLACK	x1	60	1730	450	400	50	5,00	mc. 0,045

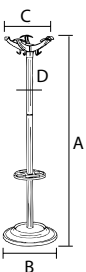

05 ELIX.G-APPENDIABITO A COLONNA CON PORTAOMBRELLI, COMPONENTI IN PLASTICA GRIGI ASSEMBLATI										
ELIX.G-COAT HANGER WITH UMBRELLA STAND, PLASTIC COMPONENTS ASSEMBLED GREY										
CODICE/CODE	FINITURA/FINISHING	PLASTICA/PLASTIC	Q. KIT	Q. MIN/PACK	A	B	C	D	KG.x1/WT.x1	VOL.x1/UNIT VOL.
110404-005	■ GRIGIO/GREY	■ GRIGIO/GREY	x1	60	1730	450	400	50	5,00	mc. 0,045
110410-039	■ CROMATO/CHROME	■ GRIGIO/GREY	x1	60	1730	450	400	50	5,00	mc. 0,045

APPENDIABILI/COAT HANGERS COMPONENTS



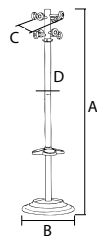

06 SKY-APPENDIABITO A COLONNA CON PORTAOMBRELLI, COMPONENTI IN PLASTICA COLORATI E ASSEMBLATI										
SKY-COAT HANGER WITH UMBRELLA, PLASTIC COMPONENTS ASSEMBLY COLOURED AND ASSEMBLED										
CODICE/CODE	FINITURA/FINISHING	PLASTICA/PLASTIC	Q. KIT	Q. MIN/PACK	A	B	C	D	KG. x1/WT.x1	VOL. x1/UNIT VOL.
110404-070	■ GRIGIO/GREY	■ VERDE/GREEN	x1	60	1730	450	330	50	5,30	mc. 0,045
110404-075	■ GRIGIO/GREY	■ BLU/BLUE	x1	60	1730	450	330	50	5,30	mc. 0,045
110404-080	■ GRIGIO/GREY	■ ARANCIO/ORANGE	x1	60	1730	450	330	50	5,30	mc. 0,045

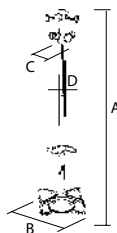

07 BRAVO-APPENDIABITO A COLONNA CON PORTAOMBRELLI, COMPONENTI IN PLASTICA NERI ASSEMBLATI										
BRAVO-COAT HANGER WITH UMBRELLA STAND, PLASTIC COMPONENTS ASSEMBLED BLACK										
CODICE/CODE	FINITURA/FINISHING		Q. KIT	Q. MIN/PACK	A	B	C	D	KG. x1/WT.x1	VOL. x1/UNIT VOL.
110402-001	■ ROSSO/RED		x1	60	1730	550	330	50	5,00	mc. 0,045
110403-001	■ NERO/BLACK		x1	60	1730	550	330	50	5,00	mc. 0,045
110404-015	■ GRIGIO/GREY		x1	60	1730	550	330	50	5,00	mc. 0,045
110405-001	□ BIANCO/WHITE		x1	60	1730	550	330	50	5,00	mc. 0,045
110410-001	■ CROMATO/CHROME		x1	60	1730	550	330	50	5,00	mc. 0,045

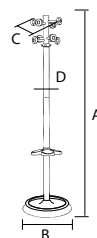

08 GOOD-APPENDIABITO A COLONNA CON PORTAOMBRELLI, COMPONENTI IN PLASTICA NERI ASSEMBLATI										
GOOD-COAT HANGER WITH UMBRELLA STAND, PLASTIC COMPONENTS ASSEMBLED BLACK										
CODICE/CODE	FINITURA/FINISHING		Q. KIT	Q. MIN/PACK	A	B	C	D	KG. x1/WT.x1	VOL. x1/UNIT VOL.
110402-015	■ ROSSO/RED		x1	60	1730	430	330	50	5,00	mc. 0,045
110403-050	■ NERO/BLACK		x1	60	1730	430	330	50	5,00	mc. 0,045
110404-020	■ GRIGIO/GREY		x1	60	1730	430	330	50	5,00	mc. 0,045
110405-030	□ BIANCO/WHITE		x1	60	1730	430	330	50	5,00	mc. 0,045
110410-030	■ CROMATO/CHROME		x1	60	1730	430	330	50	5,00	mc. 0,045



09 ECO-APPENDIABITO A COLONNA CON PORTAOMBRELLI COMPONENTI IN PLASTICA										
ECO-COAT HANGER WITH UMBRELLA STAND PLASTIC COMPONENTS ASSEMBLED										
CODICE/CODE	FINITURA/FINISHING	PLASTICA/PLASTIC	Q. KIT	Q. MIN/PACK	A	B	C	D	KG. x1/WT.x1	VOL. x1/UNIT VOL.
110403-025	■ NERO/BLACK	■ NERO/BLACK	x1	60	1730	400	330	50	5,00	mc. 0,045
110404-120	■ GRIGIO/GREY	■ NERO/BLACK	x1	60	1730	400	330	50	5,00	mc. 0,045
110410-120	■ CROMATO/CHROME	■ NERO/BLACK	x1	60	1730	400	330	50	5,00	mc. 0,045

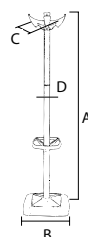

10 TREE-APPENDIABITO A COLONNA COM PORTAOMBRELLI, COMPONENTI IN PLASTICA NERI ASSEMBLATI										
TREE-COAT HANGER WITH UMBRELLA, PLASTIC COMPONENTS ASSEMBLY BLACK										
CODICE/CODE	FINITURA/FINISHING	PLASTICA/PLASTIC	Q. KIT	Q. MIN/PACK	A	B	C	D	KG. x1/WT.x1	VOL. x1/UNIT VOL.
110403-065	■ NERO/BLACK	■ NERO/BLACK	x1	50	1730	450	300	50	4,00	mc. 0,05
110404-090	■ GRIGIO/GREY	■ NERO/BLACK	x1	50	1730	450	300	50	4,00	mc. 0,05
110410-070	■ CROMATO/CHROME	■ NERO/BLACK	x1	50	1730	450	300	50	4,00	mc. 0,05

COMPLEMENTI DI ARREDO FURNISHING ACCESSORIES COMPONENTS





11 FRANK-APPENDIABITO A COLONNA COMPONENTI IN LEGNO									
FRANK-COAT HANGER, WOOD COMPONENTS									
CODICE/CODE	FINITURA/FINISHING	Q. KIT	Q. MIN/PACK	A	B	C	KG. x1/WT.x1	VOL. x1/UNIT VOL.	
110404-010	■ GRIGIO/GREY	x1	50	1800	345	390	8,60	mc. 0,026	

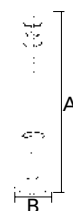

12 706-APPENDIABITO A COLONNA CON PORTA OMBRELLI COMPONENTI IN LEGNO									
706-COAT HANGER WITH UMBRELLA-STAND WOOD COMPONENTS									
CODICE/CODE	FINITURA/FINISHING	Q. KIT	Q. MIN/PACK	A	B	KG. x1/WT.x1	VOL. x1/UNIT VOL.		
110404-001	■ GRIGIO/GREY	x1	36	1780	345		8,00	mc. 0,07	

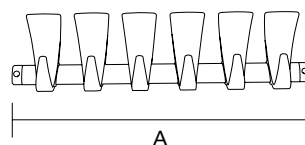

13 GRAFFIO-APPENDINO DA PARETE COLORATO									
GRAFFIO-COLOURED WALL HANGER									
CODICE/CODE	FINITURA/FINISHING	PLASTICA/PLASTIC	Q. KIT	Q. MIN/PACK	A	POSTI/PLACES	KG. x1/WT.x1	VOL. x1/UNIT VOL.	
110404-130	■ GRIGIO/GREY	■ NERO/BLACK	x1	10	250	2	0,60	mc. 0,003	
110404-131	■ GRIGIO/GREY	■ GRIGIO/GREY	x1	10	250	2	0,60	mc. 0,003	
110404-132	■ GRIGIO/GREY	■ CELESTE/LIGHT BLUE	x1	10	250	2	0,60	mc. 0,003	
110404-133	■ GRIGIO/GREY	■ ROSSO/RED	x1	10	250	2	0,60	mc. 0,003	
110404-134	■ GRIGIO/GREY	■ NERO/BLACK	x1	10	420	3	0,90	mc. 0,004	
110404-135	■ GRIGIO/GREY	■ GRIGIO/GREY	x1	10	420	3	0,90	mc. 0,004	
110404-136	■ GRIGIO/GREY	■ CELESTE/LIGHT BLUE	x1	10	420	3	0,90	mc. 0,004	
110404-137	■ GRIGIO/GREY	■ ROSSO/RED	x1	10	420	3	0,90	mc. 0,004	
110404-138	■ GRIGIO/GREY	■ NERO/BLACK	x1	10	580	4	1,10	mc. 0,005	
110404-139	■ GRIGIO/GREY	■ GRIGIO/GREY	x1	10	580	4	1,10	mc. 0,005	
110404-140	■ GRIGIO/GREY	■ CELESTE/LIGHT BLUE	x1	10	580	4	1,10	mc. 0,005	
110404-141	■ GRIGIO/GREY	■ ROSSO/RED	x1	10	580	4	1,10	mc. 0,005	

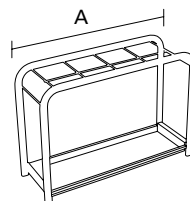

14 BIC-PORTAOMBRELLI									
BIC-UMBRELLA STAND									
CODICE/CODE	FINITURA/FINISHING	Q. KIT	Q. MIN/PACK	A	POSTI/PLACES	KG. x1/WT.x1	VOL. x1/UNIT VOL.		
110403-160	■ NERO/BLACK	x1	10	600	6	6,20	mc. 0,11		
110403-161	■ NERO/BLACK	x1	10	600	8	6,20	mc. 0,11		
110404-160	■ GRIGIO/GREY	x1	10	700	6	6,50	mc. 0,11		
110404-161	■ GRIGIO/GREY	x1	10	700	8	6,50	mc. 0,11		



NEW

ALBA  

+ COMPONENTS

POGGIAPIEDI COLONNE



FOOT RINGS



COLUMNS



FOOT RINGS
COLUMNS

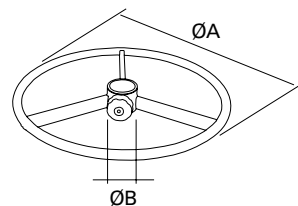

SG50T-ANELLO POGGIAPIEDI TELESCOPICO CROMATO COMPLETO DI VOLANTINO

SG50T-TELESCOPIC FOOT RING CHROME WITH LITTLE WHEEL

CODICE/CODE	FINITURA/FINISHING	Q. KIT	Q. MIN/PACK	Ø A	Ø B	KG. x1/WT.x1	VOL. x1/UNIT VOL.
110210-008	■ CROMATO/CHROME	x1	10	450	50	1,60	mc. 0,008

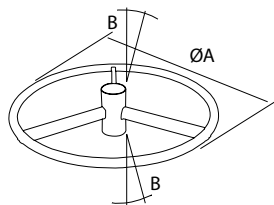

SG50F-ANELLO POGGIAPIEDI CROMATO

SG50F-FIXED FOOT RING CHROME

CODICE/CODE	FINITURA/FINISHING	Q. KIT	Q. MIN/PACK	Ø A	B	KG. x1/WT.x1	VOL. x1/UNIT VOL.
110210-005	■ CROMATO/CHROME	x1	10	450	1° 26' 16"	1,60	mc. 0,0125

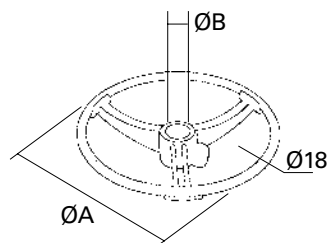

ROUND-ANELLO POGGIAPIEDI TELESCOPICO CON VOLANTINO

ROUND-TELESCOPIC FOOT RING WITH LITTLE WHEEL

CODICE/CODE	FINITURA/FINISHING	Q. KIT	Q. MIN/PACK	Ø A	Ø B	KG. x1/WT.x1	VOL. x1/UNIT VOL.
110210-009	■ CROMATO/CHROME	x1	10	450	50	1,40	mc. 0,0125

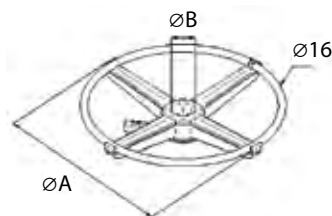

GRAVITY-ANELLO POGGIAPIEDI TELESCOPICO CROMATO COMPLETO DI LEVA

GRAVITY-TELESCOPIC FOOT RING CHROME WITH LITTLE LEVER

CODICE/CODE	FINITURA/FINISHING	Q. KIT	Q. MIN/PACK	Ø A	Ø B	KG. x1/WT.x1	VOL. x1/UNIT VOL.
110210-006	■ CROMATO/CHROME	x1	10	450	50	1,10	mc. 0,0125

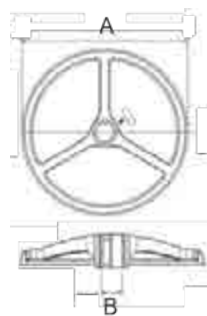

MOPO-ANELLO POGGIAPIEDI TELESCOPICO CON VOLANTINO

MOPO-TELESCOPIC FOOT RING PLASTIC WITH LITTLE WHEEL

CODICE/CODE	FINITURA/FINISHING	Q. KIT	Q. MIN/PACK	Ø A	Ø B	KG. x1/WT.x1	VOL. x1/UNIT VOL.
134003-001	■ NERO/BLACK	x1	15	450	50	1,23	mc. 0,013

POGGIAPIEDI e COLONNE / FOOT RINGS and COLUMNS

COMPONENTS

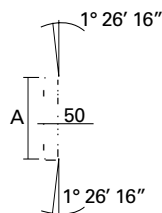

PROLUNGA PER ANELLO POGGIAPIEDI FISSO SG5F

PIPE EXTENSION FOR FOOT RING SG50F

CODICE/CODE	FINITURA/FINISHING	Q. KIT	Q. MIN/PACK	A	ØB	KG. x1/WT.x1	VOL. x1/UNIT VOL.
112303-002	■ NERO/BLACK	x1	50	130	50	0,24	mc. 0,0031
112310-031	■ CROMATO/CHROME	x1	50	130	50	0,24	mc. 0,0031
112303-004	■ NERO/BLACK	x1	50	260	50	0,48	mc. 0,0062
112310-030	■ CROMATO/CHROME	x1	50	260	50	0,48	mc. 0,0062

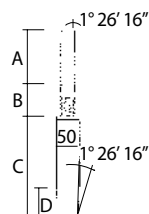

COLONNA ALZATA VITE Ø50, H 240

COLUMN SCREW Ø50, H 240

CODICE/CODE	FINITURA/FINISHING	Q. KIT	Q. MIN/PACK	A	B	C	D	KG. x1/WT.x1	VOL. x1/UNIT VOL.
112303-053	■ NERO/BLACK	x1	30	130	80	240	50	0,81	mc. 0,0190
112310-002	■ CROMATO/CHROME	x1	30	130	80	240	50	0,81	mc. 0,0190

ALTEZZA A RICHIESTA
HEIGHT ON REQUEST

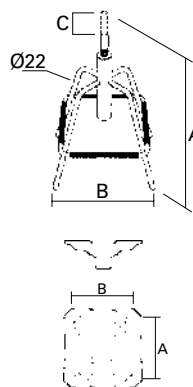

04 SG22-SGABELLI CON VITONE, TAPPI E ACCESSORI ASSEMBLATI CONO Ø21 IMBALLO SINGOLO

SG22-STOOL WITH SCREW, CAPS AND ACCESSORIES ASSEMBLED CONO Ø21 SINGLE PACKING

CODICE/CODE	FINITURA/FINISHING	Q. KIT	Q. MIN/PACK	A	B	C	KG. x1/WT.x1	VOL. x1/UNIT VOL.
110603-035	■ NERO/BLACK	x1	48	700	330	130	3,00	mc. 0,053
110610-075	■ CROMATO/CHROME	x1	48	700	330	130	3,00	mc. 0,053
110605-002	□ BIANCO/WHITE	x1	48	700	330	130	3,00	mc. 0,053

05 PIASTRA SGABELLO CONO Ø21

PLATE FOR STOOL CONE Ø21

CODICE/CODE	FINITURA/FINISHING	Q. KIT	Q. MIN/PACK	A	B	KG. x1/WT.x1	VOL. x1/UNIT VOL.
113003-100	■ NERO/BLACK	x1	20	140	140	0,85	mc. 0,001



+ COMPONENTS

BASI

BASES



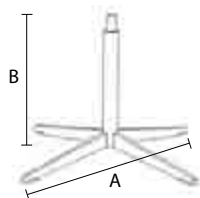

B10-BASE CON PERNO GIREVOLE ASSEMBLATA

B10-BASE WITH SWIVEL ASSEMBLED

CODICE/CODE	FINITURA/FINISHING	Q. KIT	Q. MIN/PACK	A	B	KG. x1/WT.x1	VOL. x1/UNIT VOL.
110210-076	■ CROMATO/CHROME	x1	100	700	360	4,60	mc. 0,02

ALTEZZA DA TERRA A RICHIESTA
HEIGHT FROM GROUND ON REQUEST

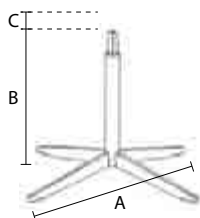

B20-BASE CON POMPA A GAS ASSEMBLATA

B20-BASE WITH GAS PUMP ASSEMBLED

CODICE/CODE	FINITURA/FINISHING	Q. KIT	Q. MIN/PACK	A	B	C	KG. x1/WT.x1	VOL. x1/UNIT VOL.
110210-080	■ CROMATO/CHROME	x1	100	700	325	60	4,80	mc. 0,02

ALTEZZA DA TERRA A RICHIESTA
HEIGHT FROM GROUND ON REQUEST

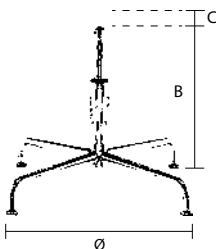

CHIP-BASE CON POMPA A GAS ASSEMBLATA COMPLETA DI PIEDINI

CHIP-BASE WITH GAS PUMP ASSEMBLED COMPLETE WITH FEET

CODICE/CODE	FINITURA/FINISHING	Q. KIT	Q. MIN/PACK	Ø	B	C	KG. x1/WT.x1	VOL. x1/UNIT VOL.
110203-005	■ NERO/BLACK	x1	100	650	385	90	2,90	mc. 0,02
110204-010	■ GRIGIO/GRAY	x1	100	650	385	90	2,90	mc. 0,02
110210-035	■ CROMATO/CHROME	x1	100	650	385	90	2,90	mc. 0,02

ALTEZZA DA TERRA A RICHIESTA
HEIGHT FROM GROUND ON REQUEST

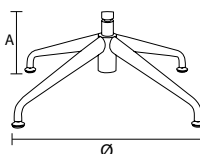

MOON-BASE A 4 RAZZE CON MECCANISMO ASSEMBLATO DI RITORNO AUTOMATICO

MOON-FOUR-STAR BASE WITH AUTO-RETURN SWIVEL MECHANISM ASSEMBLED

CODICE/CODE	FINITURA/FINISHING	Q. KIT	Q. MIN/PACK	Ø	A	KG. x1/WT.x1	VOL. x1/UNIT VOL.
110210-065	■ CROMATO/CHROME	x1	100	650	290	3,00	mc. 0,02

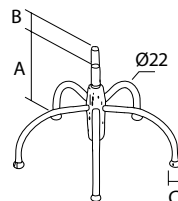

STELLA-BASE CON VITONE ASSEMBLATO COMPLETA DI COPRISALDATURA E PIEDINI PORTA RUOTA

STELLA-BASE WITH SCREW, WITH COVER WELDING AND LITTLE FEET

CODICE/CODE	FINITURA/FINISHING	Q. KIT	Q. MIN/PACK	A	B	C	KG. x1/WT.x1	VOL. x1/UNIT VOL.
110203-013	■ NERO/BLACK	x1	100	340	130	Ø 11	2,20	mc. 0,04
110204-003	■ GRIGIO/GRAY	x1	100	340	130	Ø 11	2,20	mc. 0,04
110210-022	■ CROMATO/CHROME	x1	100	340	130	Ø 11	2,20	mc. 0,04

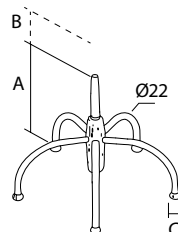

STELLA-BASE CON PISTONE A GAS ASSEMBLATO COMPLETA DI COPRISALDATURA E PIEDINI PORTA RUOTA

STELLA-BASE WITH PISTON WITH COVER WELDING AND LITTLE FEET

CODICE/CODE	FINITURA/FINISHING	Q. KIT	Q. MIN/PACK	A	B	C	KG. x1/WT.x1	VOL. x1/UNIT VOL.
110203-012	■ NERO/BLACK	x1	100	360	90	Ø 11	2,40	mc. 0,04
110204-002	■ GRIGIO/GRAY	x1	100	360	90	Ø 11	2,40	mc. 0,04
110210-020	■ CROMATO/CHROME	x1	100	360	90	Ø 11	2,40	mc. 0,04

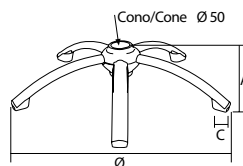

ONDA-BASE IN TUBO ELLITTICO 40X20, SPESSORE 2 mm CON COPRISALDATURA

ONDA-BASE ELLIPTICAL PIPE 40X20, THICKNESS 2 MM WITH COVER WELDING

CODICE/CODE	FINITURA/FINISHING	Q. KIT	Q. MIN/PACK	A	Ø	C	KG. x1/WT.x1	VOL. x1/UNIT VOL.
110203-020	■ NERO/BLACK	x1	150	130	580	Ø 11	2,50	mc. 0,025
110204-022	■ GRIGIO/GRAY	x1	150	130	580	Ø 11	2,50	mc. 0,025
110210-001	■ CROMATO/CHROME	x1	150	130	580	Ø 11	2,50	mc. 0,025
110203-024	■ NERO/BLACK	x1	150	130	620	Ø 11	2,65	mc. 0,025
110204-020	■ GRIGIO/GRAY	x1	150	130	620	Ø 11	2,65	mc. 0,025
110210-003	■ CROMATO/CHROME	x1	150	130	620	Ø 11	2,65	mc. 0,025

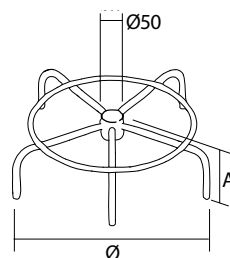

B30-BASE PER SGABELLO CON ANELLO POGGIPIEDI CONO Ø50 TAPPI ESCLUSI

B30-BASE FOR STOOL WITH FOOTREST RING CONE Ø50 CAPS EXCLUDED

CODICE/CODE	FINITURA/FINISHING	Q. KIT	Q. MIN/PACK	Ø	A	KG. x1/WT.x1	VOL. x1/UNIT VOL.
110210-025	■ CROMATO/CHROME	x1	150	540	200	2,55	mc. 0,02

01 PUNTALE ALETTATO TONDO Ø20 NERO

RIBBED ROUND INSERT CAP Ø20 BLACK

CODICE/CODE	FINITURA/FINISHING	Q. KIT
134203-200	■ NERO/BLACK	x5



NEW

+ COMPONENTS

COMPONENTI



COMPONENTS



05 SB75-STAFFA PORTABRACCIOLO SB75-SUPPORT OF ARM						
CODICE/CODE	FINITURA/FINISHING	Q. KIT	Q. MIN/PACK	KG. x1/WT.x1	VOL. x1/UNIT VOL.	
113003-017	■ NERO/BLACK	x1	50	0,45	mc. 0,002	

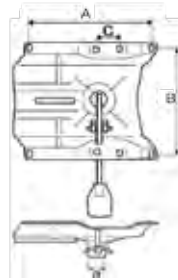

06 PIASTRA A GAS DATILO CONO 28 CON LEVA SEAT PLACE CONE 28 WITH LEVER								
CODICE/CODE	FINITURA/FINISHING	Q. KIT	Q. MIN/PACK	A	B	C Ø	KG. x1/WT.x1	VOL. x1/UNIT VOL.
113003-120	■ NERO/BLACK	x1	20	200	170	40 28	1,23	mc. 0,002

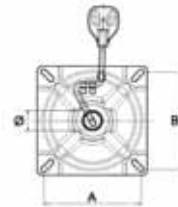

07 PSS28NR-PIASTRA SGABELLO C/SPAT. C/28 3° L4 NERA PSS28NR- SQUARE METAL PLATE WITH STRAIGHT LEVER C/28 3° L4								
CODICE/CODE	FINITURA/FINISHING	Q. KIT	Q. MIN/PACK	A	B	Ø	KG. x1/WT.x1	VOL. x1/UNIT VOL.
113003-104	■ NERO/BLACK	x1	20	150	150	28	1,23	mc. 0,002

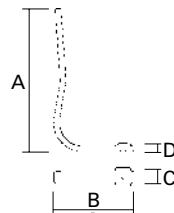

08 SH15-SCHIENALE IN TUBO OVALE CON CAVALOTTO DI RINFORZO FILETTATO SH15-OVAL BACK WITH REINFORCMENT THREADING BLACK PAINTED								
CODICE/CODE	FINITURA/FINISHING	Q. KIT	Q. MIN/PACK	A	B	C D	KG. x1/WT.x1	VOL. x1/UNIT VOL.
112103-001	■ NERO/BLACK	x1	50	330	215	30 15	0,62	mc. 0,0008

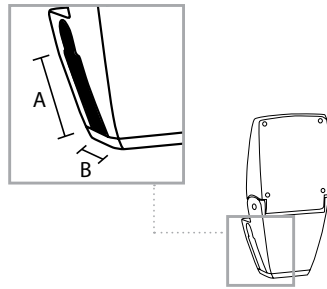

09 SITON-MECCANISMO PANCA RIBALTABILE ALLUMINIO LUCIDO									
SITON-POLISHED ALUMINIUM FOLDING MECHANISM									
CODICE/CODE	FINITURA/FINISHING	Q. KIT	Q. MIN/PACK	A	B	KG. x1/WT.x1	VOL. x1/UNIT VOL.		
110704-180	■ ALLUMINIO/ALUMINIUM	x1	4	80	40	2,81	mc. 0,007		



SCATOLA CM. 31x31 X ALTEZZA 69 - QUANTITA' 12 PEZZI
BOX CM. 31x31 X H.69 - QUANTITY 12 PCS

10 ZIP-CESTINO GETTACARTE IN LAMIERA FORATA VERNICIATO-CONFEZIONATO DA 12 PEZZI									
ZIP-PAPER LITTLE BASKET HOLE PLATE PAINTED PACKING 12 PIECES									
CODICE/CODE	FINITURA/FINISHING	Q. KIT	Q. MIN/PACK	A	B	C	KG. x1/WT.x1	VOL. x1/UNIT VOL.	
110803-015	■ NERO/BLACK	x1	12	350	250	220	0,80	mc. 0,007	
110804-015	■ GRIGIO/GREY	x1	12	350	250	220	0,80	mc. 0,007	

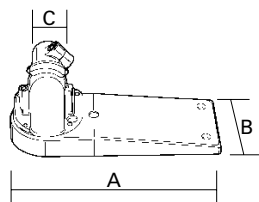

11 SPTA-SNODO TAVOLETTA ANTIPANICO IN ALLUMINIO LUCIDO									
SPTA-POLISHED ALUMINIUM SWIVEL SAFETY MECHANISM FOR TABLET									
CODICE/CODE	FINITURA/FINISHING	Q. KIT	Q. MIN/PACK	A	B	C	KG. x1/WT.x1	VOL. x1/UNIT VOL.	
111701-900	■ ALLUMINIO/ALUMINIUM DESTRO/RIGHT	x1	10	180	66	15x15	0,365	mc. 0,001	
111701-901	■ ALLUMINIO/ALUMINIUM SINISTRO/LEFT	x1	10	180	66	15x15	0,365	mc. 0,001	

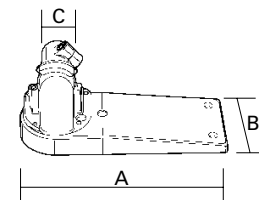

12 SPT2-SNODO PER TAVOLETTA IN TERMOPLASTICA									
SPT2-MECHANISM FOR WRITING TABLET									
CODICE/CODE	FINITURA/FINISHING	Q. KIT	Q. MIN/PACK	A	B	C	KG. x1/WT.x1	VOL. x1/UNIT VOL.	
134003-039	■ NERO/BLACK	x1	20	180	66	15x15	0,35	mc. 0,0006	

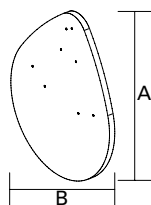

13	TL01-TAVOLETTA IN LEGNO SPESSORE 12 MM VERNICIATA FAGGIO TL01-PAINTED BEECHWOOD TABLET, THICKNESS 12 MM							
CODICE/CODE	FINITURA/FINISHING	Q. KIT	Q. MIN/PACK	A	B	KG. x1/WT.x1	VOL. x1/UNIT VOL.	
120307-006	■ FAGGIO/BEECH	x1	20	330	265	0,45	mc. 0,0	

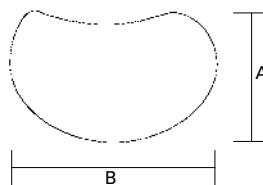

14	BEAN-TAVOLETTA IN TERMOPLASTICO SPESSORE 16 MM BEAN-WRITING TABLET IN PLASTIC THICKNESS 16 MM							
CODICE/CODE	FINITURA/FINISHING	Q. KIT	Q. MIN/PACK	A	B	KG. x1/WT.x1	VOL. x1/UNIT VOL.	
134003-044	■ NERO/BLACK	x1	20	235	370	0,40	mc. 0,002	

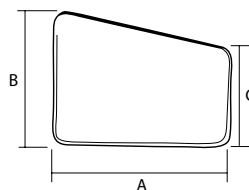

15	TLT-TAVOLETTA IN TERMOPLASTICO SPESSORE 16 MM TLT-WRITING TABLET IN PLASTIC THICKNESS 16 MM							
CODICE/CODE	FINITURA/FINISHING	Q. KIT	Q. MIN/PACK	A	B	C	KG. x1/WT.x1	VOL. x1/UNIT VOL.
134003-042	■ NERO/BLACK	x1	20	345	260	200	0,40	mc. 0,002

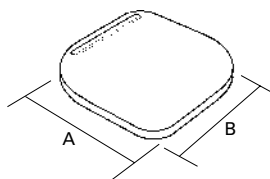

16	TLT2-TAVOLETTA IN TERMOPLASTICO OVALE SPESSORE 16 MM PER BRACCIOLO DESTRO E SINISTRO TLT2-WRITING TABLET IN OVAL PLASTIC THICKNESS 16 MM FOR LEFT AND RIGHT ARMS							
CODICE/CODE	FINITURA/FINISHING	Q. KIT	Q. MIN/PACK	A	B	KG. x1/WT.x1	VOL. x1/UNIT VOL.	
134003-040	■ NERO/BLACK	x1	20	271	271	0,40	mc. 0,002	

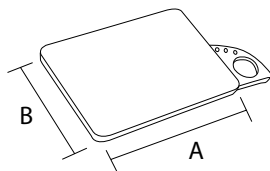

17	TLT3-TAVOLETTA AMBIDESTRO CON PORTABICCHIERE E PORTAPENNE LOGAN-WRITING TABLET WITH CUP HOLDER AND PEN TRAY							
CODICE/CODE	FINITURA/FINISHING	Q. KIT	Q. MIN/PACK	A	B	KG. x1/WT.x1	VOL. x1/UNIT VOL.	
134003-041	■ NERO/BLACK	x1	10	410	300	1,05	mc. 0,036	

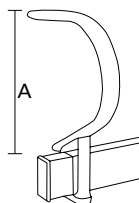

18 PIONEER-BRACCIOLO ELLIPTICO 40X20 PER PANCA CON ACCESSORI
PIONEER-ELLIPTICAL 40X20 ARM FOR BENCH WITH ACCESSORIES

CODICE/CODE	FINITURA/FINISHING	Q. KIT	Q. MIN/PACK	A	KG.x1/WT.x1	VOL.x1/UNIT VOL.
111703-015	■ NERO/BLACK	x1	5	260	1,10	mc. 0,005
111704-015	■ GRIGIO/GREY	x1	5	260	1,10	mc. 0,005
111710-015	■ CROMATO/CHROME	x1	5	260	1,10	mc. 0,005

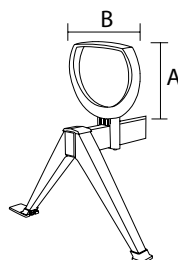

19 APOLL-BRACCIOLO IN PLASTICA + CAVALLOTTO PER PANCA
APOLL-PLASTIC ARM + SUPPORT FOR BENCH

CODICE/CODE	FINITURA/FINISHING	Q. KIT	Q. MIN/PACK	A	B	KG.x1/WT.x1	VOL.x1/UNIT VOL.
131703-065	■ NERO/BLACK	x1	10	300	270	1,10	mc. 0,008

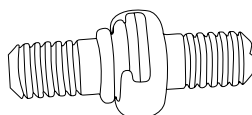

20 ISOSCELE-AGGANCIAMENTO LATERALE MASCHIO + FEMMINA IN PLASTICA CON DUE VITI
ISOSCELE-PLASTIC LATERAL HOOK MALE + FEMALE WITH 2 SCREWS

CODICE/CODE	FINITURA/FINISHING	Q. KIT	Q. MIN/PACK
134003-132	■ NERO/BLACK	x2	100

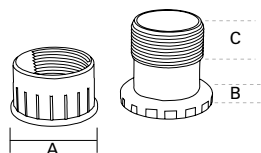

21	PR-PIEDINO REGOLABILE MASCHIO+FEMMINA PER TUBO D.50 NERO PR-ADJUSTABLE FOOT MALE+FEMALE BLACK TUBE D.50							
	CODICE/CODE 134303-026	FINITURA/FINISHING ■ NERO/BLACK	Q.KIT x1	Q.MIN/PACK 20	A 50	B 11	C 20	KG.x1/WT.x1 0,045

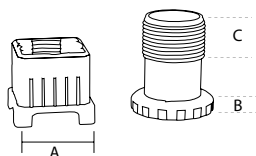

22	PR-PIEDINO REGOLABILE MASCHIO+FEMMINA PER TUBO QUADRO 40X40 NERO PR-ADJUSTABLE FOOT MALE+FEMALE BLACK TUBE 40X40 SQUARE TUBE							
	CODICE/CODE 134303-027	FINITURA/FINISHING ■ NERO/BLACK	Q.KIT x1	Q.MIN/PACK 20	A 40x40	B 11	C 20	KG.x1/WT.x1 0,045



23	PFPA-PIEDINO PER FISSAGGIO PANCA M10 (GAMBA SITON) PFPA-GLIDE FOR BENCH FIXING M10 (SITON LEG)							
	CODICE/CODE 134303-011	FINITURA/FINISHING ■ NERO/BLACK	Q.KIT x4	Q.MIN/PACK 100	A 60	B 31	C M10	KG.x1/WT.x1 0,08

24	PFPA-PIEDINO PER FISSAGGIO PANCA M8 (GAMBA 90GM, 100GM, 200GM) PFPA-GLIDE FOR BENCH FIXING M8 (90GM, 100GM, 200GM LEG)							
	CODICE/CODE 134303-012	FINITURA/FINISHING ■ NERO/BLACK	Q.KIT x4	Q.MIN/PACK 100	A 60	B 31	C M8	KG.x1/WT.x1 0,08

COMPONENTI PANCHE

BENCH COMPONENTS

COMPONENTS

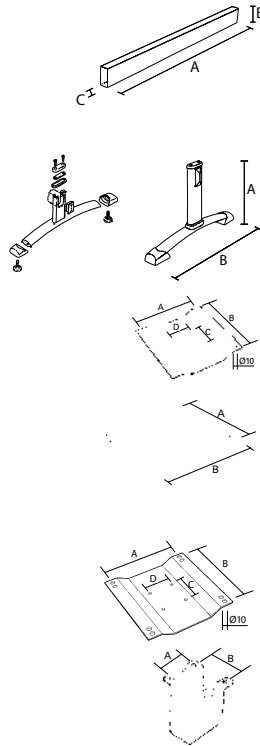
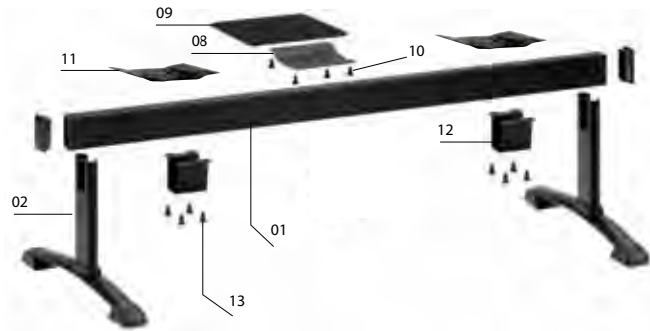

01 90T-TRAVE PER PANCA									
90T-BEAM FOR BENCH									
CODICE/CODE	FINITURA/FINISHING		Q. KIT	Q. MIN/PACK	A	B	C	KG. x1/WT.x1	VOL. x1/UNIT VOL.
110703-020	■ NERO/BLACK	2 POSTI / 2 SEATS	x1	1	1000	80	40	2,80	mc. 0,003
110704-043	■ GRIGIO/GREY	2 POSTI / 2 SEATS	x1	1	1000	80	40	2,80	mc. 0,003
110703-021	■ NERO/BLACK	3 POSTI / 3 SEATS	x1	1	1500	80	40	4,20	mc. 0,0045
110704-044	■ GRIGIO/GREY	3 POSTI / 3 SEATS	x1	1	1500	80	40	4,20	mc. 0,0045
110703-022	■ NERO/BLACK	4 POSTI / 4 SEATS	x1	1	2000	80	40	5,60	mc. 0,006
110704-045	■ GRIGIO/GREY	4 POSTI / 4 SEATS	x1	1	2000	80	40	5,60	mc. 0,006
110703-023	■ NERO/BLACK	5 POSTI / 5 SEATS	x1	1	2500	80	40	7,00	mc. 0,0085
110704-046	■ GRIGIO/GREY	5 POSTI / 5 SEATS	x1	1	2500	80	40	7,00	mc. 0,0085

02 90GM-GAMBA MOBILE PER PANCA CON ACCESSORI									
90GM-MOVABLE LEG FOR BENCH WITH ACCESSORIES									
CODICE/CODE	FINITURA/FINISHING		Q. KIT	Q. MIN/PACK	A	B	KG. x1/WT.x1	VOL. x1/UNIT VOL.	
110703-005	■ NERO/BLACK		x2	2	380	600		2,70	mc. 0,012
110704-001	■ GRIGIO/GREY		x2	2	380	600		2,70	mc. 0,012
110710-001	■ CROMATO/CHROME		x2	2	380	600		2,70	mc. 0,012

08 90AP-ATTACCO PORTA PIANO										
90AP-TABLE ATTACHMENT										
CODICE/CODE	FINITURA/FINISHING		Q. KIT	Q. MIN/PACK	A	B	C	D	KG. x1/WT.x1	VOL. x1/UNIT VOL.
110703-014	■ NERO/BLACK		x1	25	170	200	65	55	1,00	mc. 0,0002
110704-019	■ GRIGIO/GREY		x1	25	170	200	65	55	1,00	mc. 0,0002

09 90TN-PIANO TAVOLO PER PANCA									
90TN-TABLE FOR BENCH									
CODICE/CODE	FINITURA/FINISHING		Q. KIT	Q. MIN/PACK	A	B	KG. x1/WT.x1	VOL. x1/UNIT VOL.	
120303-001	■ NERO/BLACK		x1	10	400	400		2,20	mc. 0,002

10 VITE TC + M6X12 BRUNITA NERA									
SCREW TC + M6X12 BURNISHING BLACK									
CODICE/CODE	FINITURA/FINISHING		Q. KIT						
117703-177	■ NERO/BLACK		x4						

11 92P-PIASTRA PER PANCA VERNICIATA										
92P-PLATE FOR BENCH PAINT										
CODICE/CODE	FINITURA/FINISHING		Q. KIT	Q. MIN/PACK	A	B	C	D	KG. x1/WT.x1	VOL. x1/UNIT VOL.
110703-013	■ NERO/BLACK		x1	25	153	200	65	55	0,85	mc. 0,0008

12 90CV-CAVALLOTTO SOTTO TRAVE									
90CV-SUPPORT UNDER BEAM									
CODICE/CODE	FINITURA/FINISHING		Q. KIT	Q. MIN/PACK	A	B	KG. x1/WT.x1	VOL. x1/UNIT VOL.	
110703-007	■ NERO/BLACK		x1	50	55	65		0,60	mc. 0,0005
110704-015	■ GRIGIO/GREY		x1	50	55	65		0,60	mc. 0,0005

13 VITE M8X12 TESTA CILINDRICA ESAGONALE INCASSATO BRUNITA NERA									
SCREW M8X12 CYLINDRICAL HEAD HEXAGON EMBEDDED BURNISHING BLACK									
CODICE/CODE	FINITURA/FINISHING		Q. KIT						
117703-239	■ NERO/BLACK		x4						

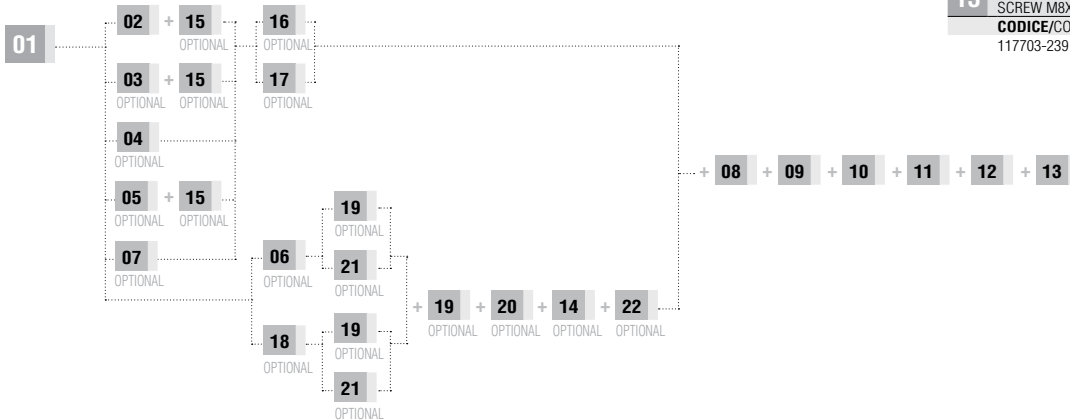

OPTIONAL GAMBA E BRACCIOLO

LEG AND ARM OPTIONAL



03 100GM-GAMBA MOBILE PER PANCA CON ACCESSORI 100GM-MOVABLE LEG FOR BENCH WITH ACCESSORIES							
CODICE/CODE	FINITURA/FINISHING	Q. KIT	Q. MIN/PACK	A	B	KG. x1/WT.x1	VOL. x1/UNIT VOL.
110703-008	■ NERO/BLACK	x2	2	380	600	2,10	mc. 0,012
110704-006	■ GRIGIO/GRAY	x2	2	380	600	2,10	mc. 0,012
110710-005	■ CROMATO/CHROME	x2	2	380	600	2,10	mc. 0,012

04 90GF-GAMBA FISSA PER PANCA CON ACCESSORI 90GF-FIXED LEG FOR BENCH WITH ACCESSORIES							
CODICE/CODE	FINITURA/FINISHING	Q. KIT	Q. MIN/PACK	A	B	KG. x1/WT.x1	VOL. x1/UNIT VOL.
110703-030	■ NERO/BLACK	x2	2	380	310	1,90	mc. 0,012
110704-012	■ GRIGIO/GRAY	x2	2	380	310	1,90	mc. 0,012

05 200GM-GAMBA MOBILE PER PANCA CON ACCESSORI 200GM-MOVABLE LEG FOR BENCH WITH ACCESSORIES							
CODICE/CODE	FINITURA/FINISHING	Q. KIT	Q. MIN/PACK	A	B	KG. x1/WT.x1	VOL. x1/UNIT VOL.
110703-110	■ NERO/BLACK	x2	4	380	600	2,60	mc. 0,005
110704-110	■ GRIGIO/GRAY	x2	4	380	600	2,60	mc. 0,005
110710-110	■ CROMATO/CHROME	x2	4	380	600	2,60	mc. 0,005

06 SITON-GAMBA CORTA IN ALLUMINIO PER PANCA SITON-SHORT ALUMINIUM LEG FOR BENCH							
CODICE/CODE	FINITURA/FINISHING	Q. KIT	Q. MIN/PACK	A	B	KG. x1/WT.x1	VOL. x1/UNIT VOL.
110704-170	■ ALLUMINIO/ALUMINIUM	x2	5	360	600	2,30	mc. 0,014

07 300GF-GAMBA FISSA PER PANCA CON ACCESSORI (FISSAGGIO A PARETE) 300GF-FIXED LEG FOR BENCH WITH ACCESSORIES (WALL FIXING)							
CODICE/CODE	FINITURA/FINISHING	Q. KIT	Q. MIN/PACK	A		KG. x1/WT.x1	VOL. x1/UNIT VOL.
110703-107	■ NERO/BLACK	x2	2	390		1,82	mc. 0,012
110704-116	■ GRIGIO/GREY	x2	2	390		1,82	mc. 0,012

14 PFFA-PIEDINO PER FISSAGGIO PANCA M10 (GAMBA SITON) PFFA-GLIDE FOR BENCH FIXING M10 (SITON LEG)								
CODICE/CODE	FINITURA/FINISHING	Q. KIT	Q. MIN/PACK	A	B	C	KG. x1/WT.x1	VOL. x1/UNIT VOL.
134303-011	■ NERO/BLACK	x4	100	60	31	M10	0,08	mc. 0,0

15 PFFA-PIEDINO PER FISSAGGIO PANCA M8 (GAMBA 90GM, 100GM, 200GM) PFFA-GLIDE FOR BENCH FIXING M8 (90GM, 100GM, 200GM LEG)								
CODICE/CODE	FINITURA/FINISHING	Q. KIT	Q. MIN/PACK	A	B	C	KG. x1/WT.x1	VOL. x1/UNIT VOL.
134303-012	■ NERO/BLACK	x4	100	60	31	M8	0,08	mc. 0,0

16 PIONEER-BRACCIOLO ELLITTICO 40X20 PER PANCA CON ACCESSORI PIONEER-ELLIPTICAL 40X20 ARM FOR BENCH WITH ACCESSORIES								
CODICE/CODE	FINITURA/FINISHING	Q. KIT	Q. MIN/PACK	A			KG. x1/WT.x1	VOL. x1/UNIT VOL.
111703-015	■ NERO/BLACK	x1	5	260			1,10	mc. 0,005
111704-015	■ GRIGIO/GREY	x1	5	260			1,10	mc. 0,005
111710-015	■ CROMATO/CHROME	x1	5	260			1,10	mc. 0,005

17 APOLL-BRACCIOLO IN PLASTICA + CAVALLOTTO PER PANCA APOLL-PLASTIC ARM + SUPPORT FOR BENCH								
CODICE/CODE	FINITURA/FINISHING	Q. KIT	Q. MIN/PACK	A	B		KG. x1/WT.x1	VOL. x1/UNIT VOL.
131703-065	■ NERO/BLACK	x1	10	275	300		0,90	mc. 0,008

COMPONENTI PANCHE

BENCH COMPONENTS

COMPONENTS

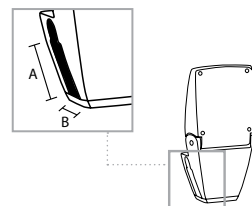
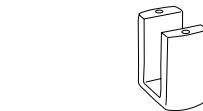

OPTIONAL SITON SITON OPTIONAL

06 SITON-GAMBA CORTA IN ALLUMINIO PER PANCA		Q. KIT	Q. MIN/PACK	A	B	KG. x1/WT.x1	VOL. x1/UNIT VOL.
SITON-SHORT ALUMINIUM LEG FOR BENCH							
CODICE/CODE	FINITURA/FINISHING						
110704-170	■ ALLUMINIO/ALUMINIUM	x2	5	600	360	2,30	mc. 0,014

18 SITON-GAMBA LUNGA IN ALLUMINIO PER PANCA		Q. KIT	Q. MIN/PACK	A	B	KG. x1/WT.x1	VOL. x1/UNIT VOL.
SITON-LONG ALUMINIUM LEG FOR BENCH							
CODICE/CODE	FINITURA/FINISHING						
110704-171	■ ALLUMINIO/ALUMINIUM	x2	5	643	305	2,80	mc. 0,014

19 SITON-BRACCIOLO IN ALLUMINIO PER PANCA		Q. KIT	Q. MIN/PACK	A	B	KG. x1/WT.x1	VOL. x1/UNIT VOL.
SITON-ALUMINIUM ARM FOR BENCH							
CODICE/CODE	FINITURA/FINISHING						
111704-030	■ ALLUMINIO/ALUMINIUM	x1	10	280	303	1,30	mc. 0,0011

20 SITON-CAVALLOTTO IN ALLUMINIO 80x40 PER BRACCIOLO PANCA		Q. KIT	Q. MIN/PACK	KG. x1/WT.x1	VOL. x1/UNIT VOL.
SITON-ALUMINIUM BRACKET 80x40 FOR BENCH ARM					
CODICE/CODE	FINITURA/FINISHING				
111704-031	■ ALLUMINIO/ALUMINIUM	x1	10	0,485	mc. 0,0012

21 SITON-COPERCHIO IN ALLUMINIO PER GAMBA PANCA		Q. KIT	Q. MIN/PACK	KG. x1/WT.x1	VOL. x1/UNIT VOL.
SITON-ALUMINIUM COVER FOR BENCH LEG					
CODICE/CODE	FINITURA/FINISHING				
110704-172	■ ALLUMINIO/ALUMINIUM	x2	10	0,113	mc. 0,0002

22 SITON-KIT DI DIECI CONFEZIONI ACCESSORI PER GAMBA PANCA		Q. KIT	Q. MIN/PACK	KG. x1/WT.x1	VOL. x1/UNIT VOL.
SITON-TEN PACKS ACCESSORIES KIT FOR LEG BENCH					
CODICE/CODE	FINITURA/FINISHING				
137000-005	■ ALLUMINIO/ALUMINIUM	x1	10	0,85	mc. 0,004

23 SITON-MECCANISMO PANCA RIBALTABILE ALLUMINIO LUCIDO		Q. KIT	Q. MIN/PACK	A	B	KG. x1/WT.x1	VOL. x1/UNIT VOL.
SITON-POLISHED ALUMINIUM FOLDING MECHANISM							
CODICE/CODE	FINITURA/FINISHING						
110704-180	■ ALLUMINIO/ALUMINIUM	x1	4	80	40	2,81	mc. 0,007

EDIZIONE 2015 / 2015 EDITION

La Metalmeccanica ALBA si riserva il diritto di apportare modifiche in qualsiasi momento al catalogo in Vostro possesso, declina inoltre ogni responsabilità per errori e/o omissioni in esso contenuti.

Metalmeccanica ALBA reserves the right to make changes in any time to the catalog in our possession and it gives any responsibility for mistake or omission in it contained.

ART DIRECTION AND DESIGN SEVENMEDIALAB

PHOTO STUDIO 04 / STUDIO ROCCI / STUDIO ODEON

PRINT GRAFICASETTE

Finito di stampare: luglio 2015



Download here
our 2015 Catalogue



Metalmeccanica Alba srl

via Boschier, 54/A
Loc. Ca' Rainati
31020 San Zenone degli Ezzelini
TREVISO (Italy)

Tel. +39.0423.969700 r.a.
Fax +39.0423.964014

info@metalmeccanicaalba.it
www.metalmeccanicaalba.com