

# ACCESSORI MOBILI

## FITTINGS FOR FURNITURE

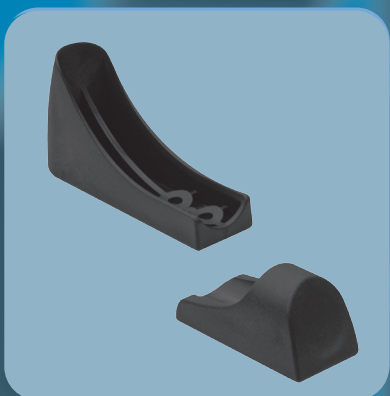

2017





via Gargnà 23/A 25078 Vestone (Bs) Italia  
Tel. +39 0365 878801  
Fax +39 0365 820000  
email: ivars@ivars.it  
http://www.ivars.it  
https://www.facebook.com/IVARS-SPA

# Accessori per mobili

## Fittings for furniture

Edizione 2017 - Revisione n° 21  
Edition 2017 - Revision nr. 21



A più di sessant'anni dalla sua fondazione, IVARS si pone oggi come una realtà produttiva di forte immagine sui mercati nazionali ed esteri.

Con una dedizione costante al lavoro, divenuta nel tempo filosofia di vita per gli uomini che vi lavorano, con una gestione da sempre oculata, con una forte propensione all'innovazione ed all'internazionalizzazione, IVARS ha saputo costruirsi nel tempo un ruolo di leadership indiscussa sul proprio mercato.

Grande attenzione è stata dedicata al continuo miglioramento dei processi aziendali e all'implementazione delle procedure interne; i nostri bilanci sono sottoposti a revisione contabile dal 1996 mentre i nostri prodotti hanno ottenuto dal 2000 la Certificazione di Qualità **UNI EN ISO 9001:2008**.

Per IVARS i traguardi raggiunti rappresentano solo il punto da cui ripartire. Questo significherà per IVARS investire su processi di produzione interni sempre più automatizzati ed efficienti, ma soprattutto di investire nella ricerca e nello sviluppo di prodotti di "alta gamma" che richiedono spesso la sperimentazione e l'impiego di nuovi materiali. In questa logica, il centro "studi e progettazione" aziendale continua a lavorare per la ricerca di nuovi prodotti, di nuove soluzioni tecniche ed estetiche, e sul miglioramento funzionale della produzione in atto.

Siamo consapevoli che essere innovativi oggi significa poter guidare l'evoluzione del domani.

*Sixty years after its foundation, IVARS is now a manufacturer company with a strong image in Italy and abroad.*

*With unwavering devotion to its work, which has gradually become a way of life for its employees, prudent management and a strong vocation for innovation and global expansion, over time IVARS has established itself as the undisputed leader of its market.*

*Great attention has been devoted to making constant improvements to company processes and implementing internal procedures; our accounts have been audited since 1996, while in 2000, our products obtained the quality certification UNI EN ISO 9001:2008.*

*For IVARS, this will mean to invest in highly automated, efficient production processes, but most importantly, to invest*

*in the research and development of high-end products, which often require the testing and use of new materials.*

*Against this background, the company's design and study centre is continuing to research new products, new technical and aesthetic solutions, and to work on functional improvements to current products.*

*We know that being innovative today means having an ability to guide the evolution of the future.*



# Indice illustrato / Illustrated index







## 01- Puntali per interno tondi- Round tube inserts

 IRA pg.10	 IRA1 pg.10	 IRA2 pg.10	 IRAP pg.11	 IRAFS pg.11	 IRAF pg.11	 IRG pg.12	 IRGI pg.12	 IRG pg.12	 PTL pg.12
 ITR pg.13	 ITR pg.13	 IRN pg.13	 IRAI pg.14	 IRAI pg.14	 IRZI pg.14	 ITSA pg.14	 ITSA pg.15	 ITSA 2 pg.15	 ITLA pg.15
 IRTA pg.15									

## 02-Copritesta rotondi- Tube cover round inserts

 CCR pg.16	 CCRC pg.16	 CCRL pg.16	 CTM pg.17	 CRM pg.17	 ITSC pg.17	 CS pg.18	 CM pg.18	 CGR pg.18	 CGR pg.19
--	---	---	--	--	---	--	---	--	--





## 03-Puntali quadri-Rectangular tube cover inserts

 QIA pg.20	 QIA pg.20	 QIAS pg.20	 QAI pg.21	 QI pg.21	 QIZ pg.21	 QAF pg.21
--	---	--	---	--	---	--

## 04-Copritesta quadri - Tube cover square inserts

 CQI pg.22	 ITSQ pg.22	 CQM pg.22	 CGQ pg.23	 CGQ pg.23
--	---	--	--	--

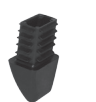
## 05-Puntali rettangolari-Rectangular tube cover inserts

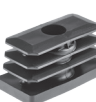
 RIA pg.24	 CRI pg.24	 RAI pg.25	 RIZ pg.25	 RIAS pg.25	 RAF pg.25	 RAFI pg.26
--	--	--	--	---	--	--

## 06-Copritesta rettangolari-Rectangular tube cover

 CRI pg.26	 CRIS pg.26	 CRIE pg.27	 CRTM pg.27	 CRG pg.27
---	---	---	---	--

## 07-Puntali a ellisse e ovali-Elliptical and oval inserts

 EIA pg.28	 EIAS pg.28	 EIAI pg.28	 EIAD pg.28	 EIADI pg.29	 OIA pg.29	 OIADI pg.29	 OIAS pg.29	 PIO pg.30	 PIO pg.30
 OAF pg.30	 PCSO pg.30	 COM pg.31	 CEI pg.31	 CEIS pg.31	 COC pg.31	 COI pg.32	 CPTA pg.32	 CPTA1 pg.32	 CONI pg.32



CENI pg.33

08-Basi piane a pinza per telai a filo - *Clips for chair wire metal frames*

					
BPP pg.33-34	BPPA pg.34	BPPD pg.34	BTF pg.34	BTFA pg.34	PPTF pg.34

09-Puntali per esterno - *Outer caps*

							
EX pg.36	EC pg.36	EL pg.37	EB pg.37	ETL pg.37	PPL pg.37	ERI pg.38	ERL pg.38

10-Puntali ovali e piedi scale - *Oval inserts and ladder feet*

							
STY pg.38	POB2 pg.38	PEO pg.38	PEE pg.39	PSAR pg.39	PSAO pg.39	PSP pg.39	PSPO pg.40

11-Puntali per scaffalature - *Inserts for shelving units*

						
ASC pg.40	ADS pg.40	ASL pg.41	AUS pg.41	EA pg.41	EAL pg.41	PEP pg.41

12-Innesti per tubi - *Tube connectors*

						
ITQ pg.42-43						

13-Articoli vari - *Miscellaneous*

									
RL pg.44	CFS pg.44	PAT pg.44	MAC pg.44	MAL pg.44	PRM pg.45	PRM pg.45	PRMS pg.45	PRMT pg.45	PMS pg.45



14-Accessori per sedie - *Fittings for chairs*

									
SP pg.46	SPL pg.46	SPQ pg.46	DP pg.47	AS pg.47	P2P pg.47	P2PA pg.47	PAR pg.48	PARP pg.48	PART pg.48
									
PATS PG 48	CSPR pg.48	CSB pg.49	PSL pg.49	PTF pg.49	PTT pg.49	AGO pg.50	BS pg.50	BSB pg.50	

15-Puntali a mezza sfera a scatto - *Snap inserts*

				
MSP pg.51	MS pg.51	MSE pg.51	MSSP pg.51	MSS pg.51

16-Distanziatori e paracolpi - *Spacers and buffers*

									
TD pg.52	DB pg.52	DR pg.52	TC pg.52	TDI pg.53	DZC pg.53	DZB pg.53	DZL pg.53	PT pg.54	RSS pg.54

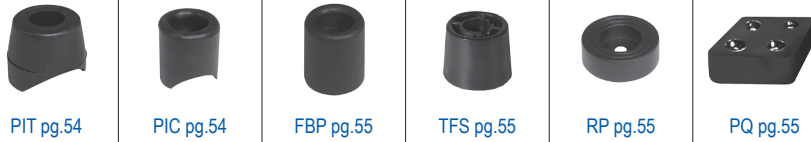

PIT pg.54

PIC pg.54

FBP pg.55

TFS pg.55

RP pg.55

PQ pg.55

17-Paracolpi a fungo - *Mushroom-shaped buffers*



PF1 pg.56

PF2 pg.56

PF3 pg.56-57

PF4 pg.57

PF5 pg.57

PF13 pg.57

PF14 pg.57

PF3B pg.58

PF15 pg.58

PF16 pg.58



P4P pg.58

18-Paracolpi a scatto - *Snap buffers*



PF7 pg.59

PF9 pg.59

PF10 pg.59

PF12 pg.59

19-Paracolpi con chiodo - *Buffers with nail*

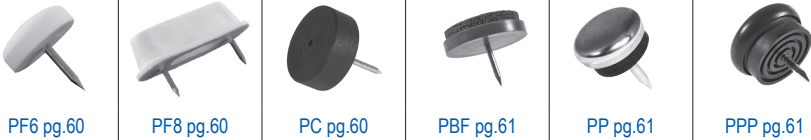

PF6 pg.60

PF8 pg.60

PC pg.60

PBF pg.61

PP pg.61

PPP pg.61

20-Articoli per reti e letti - *Articles for bed frames and nets*



IQC pg.62

IRC pg.62

PFB pg.62

PFB pg.62

PFB pg.63

CPR pg.63

CPRX pg.63

PUS pg.63

GPL pg.64

GPLD pg.64

RAR pg.64

CMR pg.65

RAP pg.65

RAPAL pg.65

EBI pg.65

PPL pg.65

PTL pg.65

STL pg.66

SARE pg.66

SAGE pg.66



CRL pg.66

21-Articoli per attaccapanni e portaombrelli - *Articles for clothes and umbrella stands*



HA01 pg.68

APP pg.68

MXA pg.68

CPA pg.68

AP4 pg.68

PFS pg.69

PAP pg.69

PPS pg.69

PATC pg.70

ITRV pg.70

AXA pg.70

ITR pg.71

ITR pg.72

VIT pg.72

GGA pg.72

DPO pg.73

DPOQ pg.73

DPOC pg.73

DU01 pg.73

CSA pg.74

BPO pg.74

BPO pg.74

BPO pg.74

PU01 pg.75

PORB pg.75

HM01 pg.76

AO2 pg.76

AO pg.76











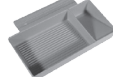







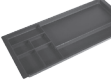
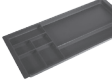
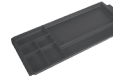

22-Articoli per spogliatoi - *Changing room items*

							
PAS pg.78	PGO pg.78	GPO pg.78	VPO pg.78	GPG pg.79	GRA pg.79	GAS pg.79	GASD pg.79



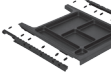
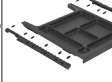
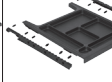



23-Accessori per tavolini e carrelli - *Items for tables and trolleys*

						
VG pg.80	VS pg.80	RR pg.80	3R pg.81	RML pg.81	RBV pg.81	FCV pg.82

24-Articoli per mobili scuola e ufficio - *Various items for school-office*

									
PGP pg.84	VLG pg.84	PPG pg.84	PQR pg.85	PCS pg.85	CSO pg.85	CSL pg.86	CSS pg.86	VC pg.86	RC pg.86
									
PR pg.87	MR pg.87	POS pg.89	POSF pg.89	POSL pg.89	POSG pg.90	POSGF pg.90	POSSL pg.90	POSGS pg.91	POSR pg.91
									
CPOP pg.93	CPO pg.93	GCS pg.93	FCPO pg.93	CESG pg.94	PODI pg.94				

25-Articoli medico-ospedalieri - *Hospital-medical articles*

					
IPF pg.96	APF2 pg.96	ASPF pg.96	RBS pg.97	RBSS pg.97	RBSL pg.97

26-Articoli per mobili legno - *Articles for wooden furniture*

									
PCP pg.98	BLR pg.98	BSR pg.98	RA pg.98	CVIE pg.99	RS pg.99	BCM pg.100	FP pg.100	MRT pg.100	MRS pg.101
									
P2GL pg.101	PFM pg.101								

27-Maniglie per mobili - *Handles for furniture*

									
MOB pg.102	MTT pg.102	MDA pg.102	MDB pg.102	MMC pg.103	MCL pg.103	MCE pg.103	MF pg.103	RMF pg.104	MML pg.104



28-Maniglie da incasso - *Recess handles*

		
MI pg.105	MIS pg.105	MIR pg.105

29-Pomoli vari - *knobs*

					
BPV pg.106	POC pg.106	PBC pg.106	POMC pg.106	PFS pg.107	POR pg.107



30-Volantini con gambo - *Star knobs*

									
VGF pg.108	VJB pg.108	VJBB pg.108	VJA pg.108	VJAB pg.109	VJS pg.109	VJSB pg.109	VSE pg.109	VSEB pg.110	VGJ pg.110
									
VTB pg.110	V30 pg.110	VZF pg.111	VPHA pg.111	VPR pg.111					

31-Volantini ciechi - *Blind knobs*

			
VCF pg.111	VJF pg.112	VZC pg.112	VFP pg.112

32-Dadi con alette - *Nuts with tongues*

	
DGA pg.112	DCA pg.112

33-Bussole filettate e autofilettanti - *Nuts*

	
B4G pg.113	BAR pg.113

34-Piedini regolabili - *Adjustable feet*

									
PRA pg.113	PRB pg.113	PRC pg.114	PRD pg.114	RFR pg.114	PREG pg.114	PBRB pg.115	PBRC pg.115	PBRD pg.115	PRP pg.115
									
PCR pg.116	RBA pg.116	PRS pg.116	RPN pg.116	PGS pg.117	PASA pg.117	RPMG pg.117	RPM pg.117	PRG pg.118	PGT pg.118
									
PRGB pg.118	PRGC pg.118	VPHA pg.119	VPR pg.119	PBZ pg.119	VPH pg.120	PRBG pg.120	PREP pg.120	PPML pg.120	PMU pg.121
									
PMU4 pg.121	PMUC pg.121	IVC pg.121	IVC pg.121	IVR pg.122	PGSR pg.122	- pg.122	PFPA pg.122		

35-Piedini snodati orientabili- *Adjustable tilt glides*

									
PS pg.123	PSC pg.123	PSD pg.123	PSA pg.123	PSB pg.123	PSE-PSG pg.124	PSF ppg.124	PSH pg.124	PSE4 pg.125	PSE5 pg.125
									
PSE8 pg.125	PSE9 pg.125	PSE9F pg.125	ES pg.125	PSEP pg.126	PGSI pg.126	PSGA pg.126	PSRS pg.126		

36-Piedini per cucina - *Feet for kitchen furniture*

									
PTGC pg.128	PFGC pg.128	GZC pg.128	SGC pg.128	PSGC pg.129	GZCI pg.129	- pg.129			

37-Componenti per mobili-*Components for furniture*

									
PGAM pg.130	PDBT pg.130	PPDA pg.130	ADP pg.131						

38-Piedini basi girevoli - *Glides for chairs and furniture*

									
BHI pg.132	GLIS pg.132	GLISC pg.132	GLIC pg.132	GLCC pg.133	GLIO pg.133	GLIA pg.133	GLIT pg.133	GLIP pg.134	GLICI pg.134

39-Doppie ruote pivotanti Ø65 (1) - *Twin- castors Ø65 (1)*

									
DRH pg.135	DRHA pg.135	DRHD pg.135	DRHAD pg.136	DRHB pg.136	DRHC pg.136	DRHDC pg.137			

40-Doppie ruote pivotanti Ø50 (1) - *Twin- castors Ø50 (1)*

									
DRG pg.137	DRA pg.137	DRS pg.138	DRGC pg.138	DRV pg.138	DRVA pg.139	DRAD pg.139	DRSD pg.139	DRVD pg.140	DRVAD pg.140
									
DRGDC pg.140	DRGD pg.141	DRCB pg.141	DRM pg.142	DRMA pg.142	DRK pg.142	DRKA pg.142	DRKD pg.143	DRKAD pg.143	DRN pg.143



41-Perni per ruote e basi pivotanti Ø47-40-36-35-30 (1) - Fitting for twin -castors Ø47-40-36-35-30 (1)

									
RTL pg.145	DRC pg.145	DRBL pg.145	DRBLB pg.146	DRB pg.146	DRBD pg.146	DRPF pg.147	- pg.147	SRPL pg.149	- pg.149



GRP pg.149

42-Perni per ruote e basi pivotanti (1) - Fitting for twin -castors (1)

				
GPB pg.150	GFR pg.150	GPR pg.150	GHI pg.150	GGR pg.151

43-Doppie ruote pivotanti Ø50 (2) - Twin- castors Ø50 (2)

		
OTO50 pg.151	OTO50CF pg.151	OTO50RG pg.151



44-Doppie ruote pivotanti Ø40-35 (2) - Twin- castors Ø40-35 (2)

					
OTO40 pg.152	OTO40CF pg.152	OTO40RG pg.152	SAR40 pg.152	SAR35 pg.153	ECO35 pg.153

45-Perni per ruote pivotanti (2) OTO-SAR-ECO- Fitting for twin-castors (2) OTO-SAR-ECO

							
GFRO pg.153	GFRR pg.153	GFRQ pg.154	GGRO pg.154	GPRO pg.154	GLRO pg.155	GLBO pg.155	GPBO pg.155

46-Attrezzi - Toolings

	
CER pg.155	- pg.155

# 01 - PUNTALI PER INTERNO ROTONDI / ROUND TUBE INSERTS

## IRA



### Puntali alettati in PE / Ribbed inserts for round tubes in PE

Codice Code	Ø	A	B	Nero/Black			Bianco/White		
				€	Pz x conf Pcs/box-bag	Lotto min Min order	€	Pz x conf Pcs/box-bag	Lotto min Min order
11.01.101.02	10	13	5	-	5000	5000	-	5000	10000
11.01.102.02	12	10	5	-	5000	5000	-	5000	10000
11.01.103.02	14	14	5	-	5000	5000	-	5000	5000
11.01.104.02	16	16	5	-	5000	5000	-	5000	5000
11.01.105.02	18	13	5	-	5000	5000	-	5000	5000
11.01.106.02	20	13	5	-	8000	8000	-	8000	8000
11.01.107.02	22	13	5	-	7000	7000	-	7000	7000
11.01.108.02	24	20	5	-	4000	4000	-	4000	10000
11.01.109.02	25	19	5	-	4000	4000	-	4000	4000
11.01.110.02	26	20	5	-	3500	3500	-	3500	10000
11.01.111.02	28	19	5	-	3000	3000	-	3000	6000
11.01.112.02	30	19	5	-	2000	2000	-	2000	2000
11.01.113.02	32	19	5	-	2500	2500	-	2500	2500
11.01.114.02	35	20	5	-	2000	2000	-	2000	10000
11.01.115.02	38	22	5	-	1500	1500	-	1500	10000
11.01.116.02	40	22	5	-	1250	1250	-	1250	1250
11.01.118.02	45	30	5	-	1000	1000	-	1000	1000
11.01.280.02	48	22	7	-	1000	1000	-	1000	1000
11.01.119.02	50	22	5	-	800	800	-	800	800
11.01.120.02	60	24	5	-	500	500	-	500	500
11.01.281.02	70	33	6	-	250	250	-	250	500
11.01.122.02	80	33	5	-	200	200	-	200	200
11.01.137.02	120	37	5	-	75	150	-	75	150

## IRA1

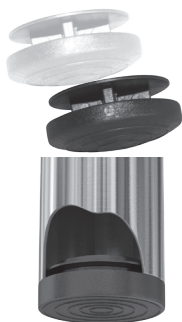

### Puntale ad una aletta in PE / One rib insert in PE

Codice Code	Ø	A	B	Nero/Black			Bianco/White		
				€	Pz x conf Pcs/box-bag	Lotto min Min order	€	Pz x conf Pcs/box-bag	Lotto min Min order
11.01.265.02	25	6	5	-	5000	10000	-	5000	10000

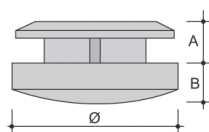

## IRA2

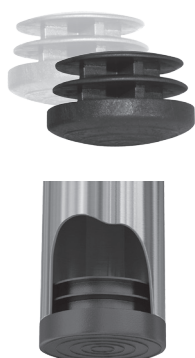

### Puntale a due alette in PE / Two ribs insert in PE

Codice Code	Ø	A	B	Nero/Black			Bianco/White		
				€	Pz x conf Pcs/box-bag	Lotto min Min order	€	Pz x conf Pcs/box-bag	Lotto min Min order
11.01.266.02	25	9	6	-	5000	5000	-	5000	5000

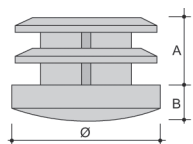

Puntali alettati in PE e base alta / Ribbed inserts for round tubes in PE high head

Codice Code	Ø	A	B	Nero/Black			Bianco/White		
				€	Pz x conf Pcs/box-bag	Lotto min Min order	€	Pz x conf Pcs/box-bag	Lotto min Min order
11.01.131.02	15	17	9	-	3000	3000	-	3000	10000
11.01.132.02	16	17	9	-	3000	3000	-	3000	10000
11.01.133.02	18	17	9	-	3000	3000	-	3000	10000
11.01.135.02	25	20	11	-	2000	2000	-	2000	10000

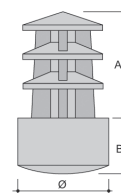

Puntale filettato senza testa in PP per tubo Ø 20 Threaded insert without head in PP for tube Ø 20

Codice Code	Ø	A	B	Nero/Black		
				€	Pz x conf Pcs/box-bag	Lotto min Min order
11.01.260.02	18	25	M6	-	5000	10.000
11.01.260.02	18	25	M8	-	5000	10.000

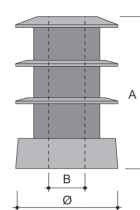

IRAFS



Puntali rotondi alettati e filettati in PP/Threaded round inserts in PP

Codice Code	Ø	A	B	Nero M8/Black M8			Nero M10/Black M10		
				€	Pz x conf Pcs/box-bag	Lotto min Min order	€	Pz x conf Pcs/box-bag	Lotto min Min order
11.01.140.02	18	18	6	-	2000	2000	-	2000	2000
11.01.141.02	20	18	6	-	2000	2000	-	2000	2000
11.01.142.02	22	19	6	-	1000	1000	-	1000	1000
11.01.143.02	25	19	6	-	2000	2000	-	2000	2000
11.01.144.02	28	19	6	-	1000	1000	-	1000	1000
11.01.152.02	28x2	19	6	-	1000	10000	-	1000	10000
11.01.145.02	30	19	6	-	1000	1000	-	1000	1000
11.01.146.02	32	19	6	-	1000	1000	-	1000	1000
11.01.147.02	35	20	6	-	1000	1000	-	1000	1000
11.01.148.02	40	20	6	-	1000	1000	-	1000	1000
11.01.150.02	45	23	6	-	500	2000	-	500	500
11.01.149.02	50	21	6	-	500	500	-	500	500
11.01.157.02	60	25	7	-	250	2000	-	250	250
11.01.151.02	80	31	8	-	200	600	-	200	200

Misure riferite al Ø esterno del tubo - Da non usare per le rotelle.  
 Sizes referred to external Ø - Not to use with castors

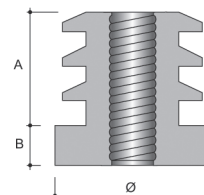

IRAF

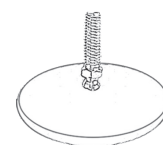

## IRG



### Puntali per ghiera / Round inserts with large base

Codice Code	Ø gambo x testa Ø for head leg	A	B	C	Nero/Black			Bianco/White		
					€	Pz x conf Pcs/box- bag	Lotto min Min order	€	Pz x conf Pcs/box- bag	Lotto min Min order
11.01.191.01	8x18	16	3	5	-	4000	4000	-	4000	12000
11.01.192.02	°7-8x18	13	3	5	-	2000	2000	-	2000	10000
11.01.193.01	10x20	17	3	5	-	2000	2000	-	2000	10000
11.01.194.01	12x24	17	4	5	-	1000	1000	-	1000	10000
11.01.195.01	14x28	17	4	5	-	1000	1000	-	1000	10000
11.01.196.02	°15-16x26	16	4	5	-	1000	1000	-	1000	10000
11.01.197.01	17x32	18	4	5	-	1000	5000	-	1000	5000
11.01.198.01	18x32	19	4	6	-	1000	5000	-	1000	5000
11.01.199.02	°19-20x34	21	4	5	-	1000	1000	-	1000	5000
11.01.201.02	°22-23x36	29	4	6	-	1000	1000	-	1000	5000

Le misure indicate con (°) sono alettate e in PE. Le altre sono lisce e in PVC.  
 Sizes indicated (°) are ribbed and in Pe. The smooth ones are in PVC

## IRGI



### Puntale per ghiera inclinato 12° in PE / Round insert with large base in PE inclined 12°

Codice Code	misure dimensions	A	B	C	Nero/Black			Bianco/White		
					€	Pz x conf Pcs/box- bag	Lotto min Min order	€	Pz x conf Pcs/box- bag	Lotto min Min order
11.01.228.02	22-23x36	19	1,5	7,5	-	1000	5000	-	1000	5000

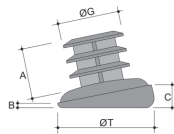

## IRG

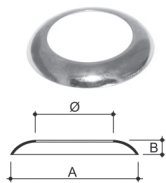

### Ghiera per puntali / Metal ring for round inserts

Codice Code	misure dimensions	A	B	Cromato/Chrome plated		
				€	Pz x conf Pcs/box- bag	Lotto min Min order
11.01.211.68	7-8	18	3	-	4000	4000
11.01.212.68	10	20	3	-	4000	4000
11.01.213.68	12	24	4	-	2000	6000
11.01.214.68	14	28	4	-	1000	10000
11.01.215.68	16	26	4	-	1000	1000
11.01.216.68	17-18	32	4	-	1000	5000
11.01.217.68	20	34	4	-	1000	5000
11.01.218.68	22	36	4	-	1000	5000

## PTL



### Puntale testa larga Ø40 per tubo spess.1 / Big head insert Ø40 with thickness 1 mm

Codice Code	Ø	A	B	C	D	Nero/Black		
						€	Pz x conf Pcs/box- bag	Lotto min Min order
11.01.183.02	40	38	49	20	6	-	1250	1250

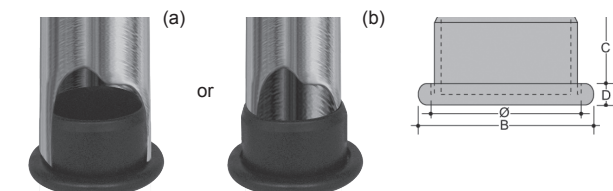

Innesto per tubi rotondi in PS / Tube connectors in PS

ITR

Codice Code	A	B	C	S.T.	Nero/Black		
					€	Pz x conf Pcs/box-bag	Lotto min Min order
11.24.209.76	35	29	8MA	1	-	500	1000
21.24.210.00	40	32	8MA	1	-	100	400
11.24.211.76	50	34	8MA	1	-	600	3000

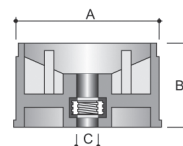

Innesto per tubi rotondi filettato in PA / Threaded connector for round tube in PA

ITR

Codice Code	A	B	D	S.T.	Nero/Black		
					€	Pz x conf Pcs/box-bag	Lotto min Min order
11.24.208.05	30	4	8MA	1,2	-	1000	1000

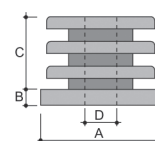

Puntali o sottopiedi in PVC / Ribbed inserts in PVC

IRN

Codice Code	Ø	A	B	C	Nero/Black			Bianco/White		
					€	Pz x conf Pcs/box-bag	Lotto min Min order	€	Pz x conf Pcs/box-bag	Lotto min Min order
11.01.231.01	8	14	5	12	-	10000	10000	-	10000	10000
11.01.232.01	9	15	5	13	-	10000	10000	-	10000	10000
11.01.233.01	10	14	5	14	-	10000	10000	-	10000	10000
11.01.234.01	11	16	6	15	-	5000	10000	-	5000	10000
11.01.235.01	12	16	6	16	-	5000	10000	-	5000	10000
11.01.236.01	13	16	7	17	-	5000	10000	-	5000	10000
11.01.237.01	14	18	7	19	-	4000	10000	-	4000	10000
11.01.238.01	15	18	7	20	-	5000	10000	-	5000	10000
11.01.239.01	16	19	8	21	-	2000	10000	-	2000	10000
11.01.240.01	17	19	8	22	-	2500	10000	-	2500	10000
11.01.241.01	18	19	8	23	-	2500	10000	-	2500	10000
11.01.242.01	19	19	6	24	-	-	10000	-	-	10000
11.01.243.01	20	20	7	25	-	2500	10000	-	2500	10000
11.01.244.01	21	21	7	25	-	2000	10000	-	2000	10000
11.01.245.01	22	20	7	26	-	-	10000	-	-	10000
11.01.246.01	23	20	7	28	-	1000	10000	-	1000	10000
11.01.247.01	24	20	7	29	-	1000	10000	-	1000	10000
11.01.248.01	25	20	7	29	-	2000	10000	-	2000	10000
11.01.249.01	26	20	8	31	-	1000	5000	-	1000	5000
11.01.250.01	27	20	8	31	-	1000	5000	-	1000	5000
11.01.251.01	28	22	9	34	-	1000	5000	-	1000	5000
11.01.252.01	29	22	8	34	-	1000	5000	-	1000	5000
11.01.256.01	40	25	10	45	-	1000	5000	-	1000	5000

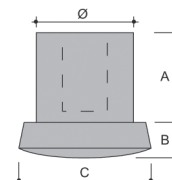

## IRAI



Codice Code	Ø	A	B	Nero/Black			Bianco/White		
				€	Pz x conf Pcs/box-bag	Lotto min Min order	€	Pz x conf Pcs/box-bag	Lotto min Min order
11.01.161.02	16	15	5	-	5000	5000	-	5000	5000
11.01.162.02	18	15	5	-	5000	5000	-	5000	5000
11.01.164.02	22	18	6	-	5000	5000	-	5000	5000
11.01.165.02	25	18	6	-	2500	5000	-	2500	5000
11.01.166.02	28	18	6	-	2500	5000	-	2500	5000
11.01.170.02	60	40	6	-	500	1000	-	500	1000

## IRAI



Codice Code	Ø	A	B	C	Nero/Black			Bianco/White		
					€	Pz x conf Pcs/box-bag	Lotto min Min order	€	Pz x conf Pcs/box-bag	Lotto min Min order
21.01.171.00	25	18	5	10	-	2000	4000	-	2000	4000

## IRZI



Codice Code	Ø	A	B	C	Nero/Black			Bianco/White		
					€	Pz x conf Pcs/box-bag	Lotto min Min order	€	Pz x conf Pcs/box-bag	Lotto min Min order
11.01.178.02	18	21	16	5	-	5000	5000	-	5000	5000
11.01.181.02	25	25	23	6	-	2000	2000	-	2000	5000

## ITSA

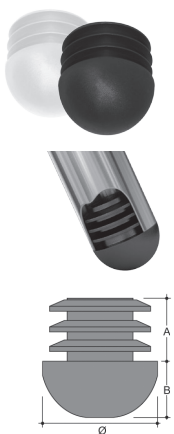

Codice Code	Ø testa Ø head	A	B	Nero/Black			Bianco/White		
				€	Pz x conf Pcs/box-bag	Lotto min Min order	€	Pz x conf Pcs/box-bag	Lotto min Min order
11.01.287.02	16	12	7	-	4000	4000	-	4000	4000
11.01.288.02	18	12	7,5	-	4000	4000	-	4000	4000
11.01.289.02	20	15	9,0	-	4000	4000	-	4000	4000
11.01.290.02	22	15	10,0	-	4000	4000	-	4000	8000
11.01.291.02	25	15	11,0	-	4000	4000	-	4000	4000
11.01.292.02	28	16	12,5	-	3000	3000	-	3000	6000
11.01.293.02	30	18	13,5	-	2500	2500	-	2500	5000
11.01.294.02	32	18	16,5	-	2000	2000	-	2000	4000
11.01.295.02	35	20	17,0	-	1500	1500	-	1500	6000
11.01.297.02	40	22	19,5	-	1000	1000	-	1000	5000
11.01.299.02	60	30	32	-	250	250	-	250	1000

Puntali copritesta-testa sferica alettati in PE per tubo spess. 2 mm  
Spherical round cover tube in PE, for tube thickness 2 mm

Codice Code	Ø testa Ø head	S.T.	A	B	Nero/Black			Bianco/White		
					€	Pz x conf Pcs/box-bag	Lotto min Min order	€	Pz x conf Pcs/box-bag	Lotto min Min order
11.01.286.02	14	2.0	10	9	-	5000	10000	-	5000	10000

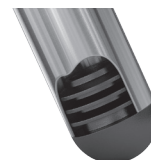
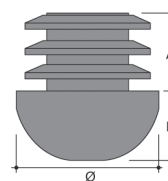

ITSA

Puntali copritesta, a testa semisferica in PP / Spherical round cover tube in PP

Codice Code	Ø testa Ø head	A	B	Nero/Black			Bianco/White		
				€	Pz x conf Pcs/box-bag	Lotto min Min order	€	Pz x conf Pcs/box-bag	Lotto min Min order
11.01.310.02	20	15	7,5	-	4000	4000	-	4000	4000
11.01.311.02	22	17	8,5	-	4000	4000	-	4000	4000
11.01.312.02	25	18	10	-	4000	4000	-	4000	4000
11.01.313.02	30	20	10,5	-	2500	2500	-	2500	5000

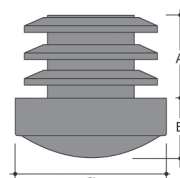

ITSA2

Puntali copritesta, a testa liscia in PP / Cover tube with smooth head in PP

Codice Code	Ø testa Ø head	A	B	Nero/Black			Bianco/White		
				€	Pz x conf Pcs/box-bag	Lotto min Min order	€	Pz x conf Pcs/box-bag	Lotto min Min order
11.01.320.02	20	15	7,5	-	4000	4000	-	4000	4000
11.01.321.02	22	17	8	-	4000	4000	-	4000	4000
11.01.322.02	25	18	9	-	4000	4000	-	4000	4000
11.01.323.02	30	20	10	-	2500	2500	-	2500	5000

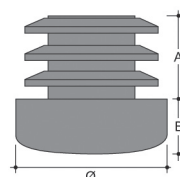

ITLA

Puntale testa alta D22 H57.5 / High head insert D22 H57.5

Codice Code	A	B	C	D	Nero/Black		
					€	Pz x conf Pcs/box-bag	Lotto min Min order
11.01.300.05	Ø 22	Ø 18	57.5	95	-	-	-

Per tubo spessore 2 mm  
For tube thickness 2 mm

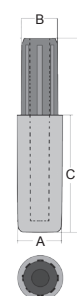

IRTA

## 02 - COPRITESTA ROTONDI / TUBE COVER ROUND INSERTS

### CCR

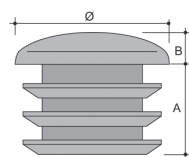

#### Copritesta alettato in PE / Ribbed inserts in PE

Codice Code	Ø testa Ø head	A	B	Nero/Black			Bianco/White		
				€	Pz x conf Pcs/box- bag	Lotto min Min order	€	Pz x conf Pcs/box- bag	Lotto min Min order
11.02.111.02	10	8	2	-	10000	10000	-	10000	10000
11.02.112.02	12	8	2	-	10000	10000	-	10000	10000
11.02.113.02	14	8	2	-	10000	10000	-	10000	10000
11.02.114.02	15	8	3	-	10000	10000	-	10000	20000
11.02.115.02	16	9,5	3	-	10000	10000	-	10000	10000
11.02.116.02	18	9	3	-	10000	10000	-	10000	10000
11.02.117.02	20	9,5	4	-	5000	5000	-	5000	5000
11.02.106.02	22	10	4	-	7500	7500	-	7500	7500
11.02.107.02	25	13	4	-	4000	4000	-	4000	4000
11.02.108.02	28	15	5	-	3000	3000	-	3000	3000
11.02.109.02	30	17	5	-	3000	3000	-	3000	6000
11.02.090.02	32	16	5	-	2500	2500	-	2500	5000
11.02.091.02	35	17	5	-	2000	2000	-	2000	2000
11.02.092.02	40	17	3	-	1500	1500	-	1500	1500
11.02.093.02	45	17	5	-	1000	1000	-	1000	1000
11.02.094.02	50	17	5	-	1000	1000	-	1000	1000
11.02.095.02	60	17	5	-	750	750	-	750	1500
11.02.097.02	80	17	6	-	400	400	-	400	1200
11.02.084.02	90	23	7	-	250	250	-	250	1000
11.02.085.02	100	29	6	-	100	100	-	100	1000

### CCRC

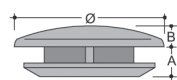

#### Copritesta a un'aletta in PE / One ribbed insert in PE

Codice Code	Ø testa Ø head	A	B	Nero/Black			Bianco/White		
				€	Pz x conf Pcs/box- bag	Lotto min Min order	€	Pz x conf Pcs/box- bag	Lotto min Min order
11.02.330.02	25	5	3,5	-	5000	5000	-	5000	10000

### CCRL

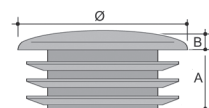

#### Copritesta alettato in PE / Ribbed inserts in PE

Codice Code	Ø testa Ø head	A	B	Nero/Black		
				€	Pz x conf Pcs/box- bag	Lotto min Min order
11.02.350.02	38	12	3,5	-	3000	3000

Copritesta alettato in PE-testa in FE cromato / Ribbed insert in PE with metal head

CTM

Codice Code	Ø testa Ø head	A	B	Cromato / Chrome Plated		
				€	Pz x conf Pcs/box-bag	Lotto min Min order
11.02.224.52	13	8	2	-	1000	4000
11.02.225.52	14	10	2	-	1000	2000
11.02.226.52	16	10	2	-	1000	2000
11.02.227.52	18	10	2	-	1000	2000
11.02.223.52	19	10	2	-	1000	3000
11.02.228.52	20	10	3	-	1000	3000
11.02.229.52	22	11	3	-	1000	3000
11.02.231.52	25	15	3	-	1000	3000
11.02.230.52	25x1.5	15	3	-	1000	3000
11.02.232.52	25x1.8	15	3	-	1000	20000
11.02.238.52	25x2.0	15	3	-	1000	3000
11.02.269.52	25x4.5	15	3	-	1000	10000
11.02.233.52	28	15	3	-	500	2000
11.02.221.52	28.6	15	3	-	500	20000
11.02.234.52	30	16	3	-	500	2000
11.02.235.52	32	16	3	-	250	2000
11.02.236.52	35	16	3	-	250	2000
11.02.240.52	38	16	3	-	250	1000
11.02.237.52	40	16	3	-	250	1000
11.02.239.52	45	16	3	-	250	750

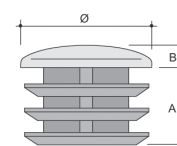

Copritesta in PP con testa in FE cromato / Ribbed insert in PE and metal top

CRM

Codice Code	Ø T	S.T.	A	B	Cromato / Chrome Plated		
					€	Pz x conf Pcs/box-bag	Lotto min Min order
11.02.245.52	50	1.0	12	3	-	200	600
11.02.246.52	50	1.2	12	3	-	200	600
11.02.247.52	50	1.5	12	3	-	200	600
11.02.248.52	50	2.0	12	3	-	200	1200
11.02.249.52	60	1.0	16	3	-	200	1000
11.02.250.52	60	1.2	16	3	-	200	800
11.02.251.52	60	1.5	16	3	-	200	400
11.02.252.52	60	2.0	16	3	-	200	400
11.02.258.52	80	1.2	12	3	-	100	1000
11.02.259.52	80	1.5	12	3	-	100	1000

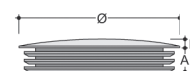
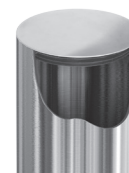

Copritesta alettato in PE con testa sferica in FE cromato / Ribbed insert in PE with round metal head

ITSC

Codice Code	Ø testa Ø head	A	B	Cromato / Chrome Plated		
				€	Pz x conf Pcs/box-bag	Lotto min Min order
11.02.065.52	25	15	12	-	500	4000

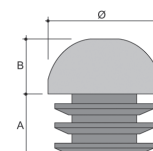

# CS



## Copritesta a sfera in PVC / Round ball in PVC

Codice Code	Ø Sfera Ø Ball	A	Ø B	Nero/Black			Colorato/Bianco Coloured/White		
				€	Pz x conf Pcs/box-bag	Lotto min Min order	€	Pz x conf Pcs/box-bag	Lotto min Min order
11.02.161.01	10	7	3	-	15000	15000	-	15000	30000
11.02.162.01	10	8	4	-	15000	15000	-	15000	30000
11.02.163.01	14	12	5	-	15000	15000	-	15000	30000

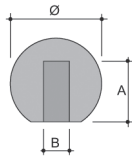

Adatte per terminali filo ferro  
Suitable for wires

# CM

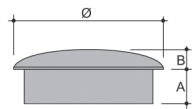

Adatti per turare le estremità dei tubi.  
Suitable to close tubes.

## Copritesta tubi in FE imbutito / Round insert in metal

Codice Code	Ø T	S.T	A	B	Ferro/Metal		
					€	Pz x conf Pcs/box-bag	Lotto min Min order
11.02.182.67	16	1,5	7	2	-	1000	5000
11.02.183.67	18	1,5	7	2	-	1000	1000
11.02.184.67	18	1,2	7	2	-	1000	5000
11.02.180.67	18	1,0	7	2	-	1000	5000
11.02.181.67	20	1,5	10	2	-	1000	5000
11.02.185.67	20	1,2	10	2	-	1000	1000
11.02.178.67	20	1,0	10	2	-	1000	5000
11.02.179.67	22	1,5	9	3	-	1000	1000
11.02.186.67	22	1,2	9	3	-	1000	1000
11.02.167.67	22,2	1,15	-	-	-	1000	5000
11.02.188.67	25	1,2	9	3	-	1000	1000
11.02.187.67	25	1,5	9	3	-	1000	1000
11.02.189.67	28	1,5	7	3	-	1000	1000
11.02.195.67	30	2,0	8	3	-	1000	1000
11.02.190.67	30	1,5	8	3	-	1000	1000
11.02.176.67	30	0,85	8	3	-	1000	10000
11.02.191.67	32	2,0	8	3	-	1000	1000
11.02.192.67	32	1,5	8	3	-	1000	1000
11.02.193.67	32	1,2	8	3	-	1000	5000
11.02.194.67	32	1,0	8	3	-	1000	5000
11.02.196.67	35	1,5	9	3	-	500	500
11.02.197.67	35	1,2	9	3	-	500	500
11.02.198.67	35	1,0	9	3	-	500	5000
11.02.199.67	40	1,0	9	4	-	500	5000
11.02.166.67	40	1,5	9	4	-	500	500

# CGR



## Copritesta rotondi in ABS / Round insert in ABS

Codice Code	ØT	S.T.	A	B	Nero/Black			Cromato/Chrome Plated			Dorato (oro galvanico) Gold Plated (galvanic gold)		
					€	Pz x conf Pcs/box-bag	Lotto min Min order	€	Pz x conf Pcs/box-bag	Lotto min Min order	€	Pz x conf Pcs/box-bag	Lotto min Min order
21.02.125.00	8	1	4,5	1,5	-	1000	6000	-	1000	6000	-	1000	6000
21.02.126.00	10	1	5	2	-	1000	6000	-	1000	6000	-	1000	6000
21.02.127.00	12	1	5	2	-	1000	5000	-	1000	5000	-	1000	5000
21.02.309.00	13	1	6	2	-	1000	5000	-	1000	5000	-	1000	5000
21.02.128.00	14	1	8	3	-	1000	5000	-	1000	5000	-	1000	5000

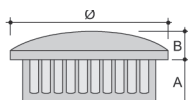

Copritesta rotondi in ABS / Round insert in ABS

CGR

Codice Code	Ø T	S.T	A	B	Nero/Black			Cromato Metallizzato Chromed plated Brass metal- lized		
					€	Pz x conf Pcs/box- bag	Lotto min Min order	€	Pz x conf Pcs/box- bag	Lotto min Min order
21.02.129.00	16	1	8	3	-	1000	2000	-	1000	2000
21.02.203.00	16	1,2	8	3	-	1000	2000	-	1000	2000
21.02.217.00	16	1,5	8	3	-	1000	2000	-	1000	2000
21.02.132.00	18	1	8	3	-	1000	2000	-	1000	2000
21.02.131.00	18	1,2	8	3	-	1000	2000	-	1000	2000
21.02.130.00	18	1,5	8	4	-	1000	2000	-	1000	2000
21.02.220.00	19	1,2	9	4	-	1000	2000	-	1000	2000
21.02.241.00	19	1,5	9	5	-	1000	2000	-	1000	2000
21.02.135.00	20	1	8	5	-	1000	2000	-	1000	2000
21.02.134.00	20	1,2	8	5	-	1000	2000	-	1000	2000
21.02.133.00	20	1,5	8	5	-	1000	2000	-	1000	2000
21.02.138.00	22	1	8	5	-	500	1000	-	500	1000
21.02.137.00	22	1,2	8	5	-	500	1000	-	500	1000
21.02.136.00	22	1,5	8	5	-	500	1000	-	500	1000
21.02.244.00	22	2	8	5	-	500	1000	-	500	1000
21.02.142.00	25	1	8	5	-	500	1000	-	500	1000
21.02.141.00	25	1,2	8	5	-	500	1000	-	500	1000
21.02.140.00	25	1,5	8	5	-	500	1000	-	500	1000
21.02.139.00	25	2	8	5	-	500	1000	-	500	1000
21.02.209.00	25.4	1,25	8	5	-	500	1000	-	500	1000
21.02.146.00	28	1	10	5	-	250	500	-	250	500
21.02.145.00	28	1,2	10	5	-	250	500	-	250	500
21.02.144.00	28	1,5	10	5	-	250	500	-	250	500
21.02.143.00	28	2	10	5	-	250	500	-	250	500
21.02.150.00	30	1	10	5	-	250	500	-	250	500
21.02.149.00	30	1,2	10	5	-	250	500	-	250	500
21.02.148.00	30	1,5	10	5	-	250	500	-	250	500
21.02.147.00	30	2	10	5	-	250	500	-	250	500
21.02.211.00	32	1,2	10	5	-	250	500	-	250	500
21.02.210.00	32	1,5	10	5	-	250	500	-	250	500
21.02.291.00	32	2	10	5	-	250	500	-	250	500
21.02.310.00	32	3	10	5	-	250	500	-	250	500
21.02.292.00	35	1	10	5	-	200	600	-	200	600
21.02.156.00	35	1,2	10	5	-	200	600	-	200	600
21.02.158.00	35	1,5	10	5	-	200	600	-	200	600
21.02.293.00	35	2	10	8	-	200	600	-	200	600
21.02.152.00	38	1,5	10	3	-	200	400	-	200	400
21.02.151.00	38	2	10	3	-	200	400	-	200	400
21.02.296.00	40	1	10	3	-	200	400	-	200	400
21.02.159.00	40	1,5	10	3	-	200	400	-	200	400
21.02.153.00	40	2	10	3	-	200	400	-	200	400
21.02.311.00	45	1,5	11	4	-	200	200	-	200	200
21.02.312.00	45	2	11	4	-	200	200	-	200	200
21.02.154.00	50	1	11	5	-	200	200	-	200	200
21.02.160.00	50	1,2	11	5	-	200	200	-	200	200
21.02.157.00	50	1,5	11	5	-	200	200	-	200	200
21.02.298.00	50	2	11	5	-	200	200	-	200	200
21.02.155.00	60	1	11	5	-	100	200	-	100	200
21.02.201.00	60	1,2	11	5	-	100	200	-	100	200
21.02.202.00	60	1,5	11	5	-	100	200	-	100	200
21.02.205.00	70	1,2	11	5	-	100	200	-	100	200
21.02.204.00	70	1,5	11	5	-	100	200	-	100	200
21.02.206.00	80	1,2	11	5	-	100	100	-	100	100
21.02.200.00	80	1,5	11	5	-	100	100	-	100	100
21.02.208.00	90	1,2	11	5	-	50	100	-	50	100
21.02.207.00	90	1,5	11	5	-	50	100	-	50	100
21.02.124.00	120	5	16	8	-	25	25	-	25	25

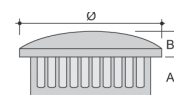

## 03 - PUNALI QUADRI / SQUARE TUBE INSERTS

### QIA

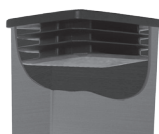
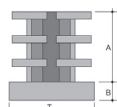
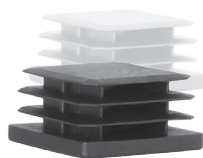

#### Puntali quadri alettati in PE / Square inserts in PE

Codice Code	Testa Head	A	B	Nero/Black			Bianco/White		
				€	Pz x conf Pcs/box-bag	Lotto min Min order	€	Pz x conf Pcs/box-bag	Lotto min Min order
11.03.121.02	12x12	12	5	-	3000	3000	-	3000	12000
11.03.122.02	15x15	11	4	-	2500	2500	-	2500	10000
11.03.123.02	16x16	17	5	-	2500	2500	-	2500	10000
11.03.124.02	18x18	12	5	-	2500	2500	-	2500	10000
11.03.125.02	20x20	17	5	-	5000	5000	-	5000	5000
11.03.126.02	22x22	17	5	-	2000	2000	-	2000	6000
11.03.127.02	25x25	17	5	-	2500	2500	-	2500	5000
11.03.128.02	30x30	19	5	-	2000	2000	-	2000	6000
11.03.129.02	35x35	18	6	-	1000	1000	-	1000	5000
11.03.130.02	40x40	18	6	-	1000	1000	/	/	/
11.03.131.02	50x50	22	6	-	600	600	/	/	/
11.03.132.02	60x60	24	6	-	500	500	-	500	1000
11.03.134.02	70x70	25	6	-	300	300	-	300	900
11.03.137.02	80x80	30	6	-	150	150	-	150	900
11.03.138.02	100x100	30	6	-	100	100	-	100	1000

#### Puntale quadro alettato in PE per tubo 2 mm / Square inserts in PE for tube 2 mm

Codice Code	Testa Head	A	B	Nero/Black			Bianco/White		
				€	Pz x conf Pcs/box-bag	Lotto min Min order	€	Pz x conf Pcs/box-bag	Lotto min Min order
11.03.145.02	15x15	14	8	-	5000	10000	-	5000	10000

#### Puntali quadri alettati in PE-Alettatura a croce / Square inserts in PE-Crossed ribs

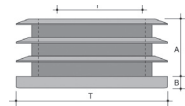
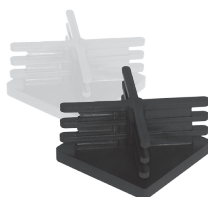

Codice Code	Testa Head	A	B	Nero/Black			Bianco/White		
				€	Pz x conf Pcs/box-bag	Lotto min Min order	€	Pz x conf Pcs/box-bag	Lotto min Min order
11.03.148.02	15x15	11	4	-	2500	10000	-	2500	10000
11.03.140.02	25x25	20	6	-	2000	10000	-	2000	10000
11.03.147.02	30x30	21	6	-	2000	10000	-	2000	10000
11.03.135.02	32x32	21	6	-	1000	5000	-	1000	5000
11.03.119.02	35x35	21	6	-	1000	5000	-	1000	5000
11.03.150.02	40x40	21	6	-	1000	1000	-	1000	5000
11.03.133.02	45x45	21	5	-	500	500	-	500	5000
11.03.142.02	50x50	21	6	-	600	600	-	600	6000
11.03.141.02	60x60	22	6	-	450	4500	-	450	4500

### QIAS

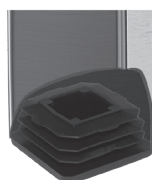
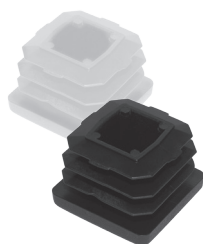

#### Puntali quadri alettati in PE / Square inserts in PE

Codice Code	Testa Head	S.T.	A	B	Nero/Black			Bianco/White		
					€	Pz x conf Pcs/box-bag	Lotto min Min order	€	Pz x conf Pcs/box-bag	Lotto min Min order
11.03.270.02	30x30	1	17	5,5	-	2000	2000	-	2000	6000
11.03.271.02	30x30	1	17	7,5	-	2000	10000	-	2000	10000

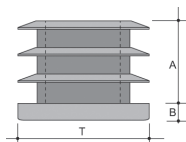

Puntali quadrati alettati inclinati 30° in PE / *Inclined square inserts 30°*

QAI

Codice Code	Per tubo For tube	A	B	Nero/Black			Bianco/White		
				€	Pz x conf Pcs/box-bag	Lotto min Min order	€	Pz x conf Pcs/box-bag	Lotto min Min order
11.03.166.02	20x20	19	6	-	1000	5000	-	1000	10000
11.03.167.02	25x25	18	6	-	1000	1000	-	1000	10000
11.03.168.02	30x30	20	6	-	1000	1000	-	1000	10000

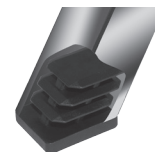
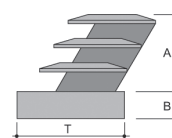

Puntali quadrati in PVC / *Square inserts in PVC*

QI

Codice Code	Gambo Stem	A	B	Nero/Black			Bianco/White		
				€	Pz x conf Pcs/box-bag	Lotto min Min order	€	Pz x conf Pcs/box-bag	Lotto min Min order
11.03.101.01	12x12	19	6	-	-	10000	-	-	10000
11.03.102.01	13x13	20	6	-	-	10000	-	-	10000
11.03.103.01	14x14	20	6	-	-	10000	-	-	10000
11.03.104.01	15x15	20	6	-	-	10000	-	-	10000
11.03.105.01	16x16	20	6	-	2500	5000	-	2500	5000
11.03.106.01	17x17	20	6	-	1000	5000	-	1000	5000
11.03.107.01	18x18	20	6	-	-	5000	-	-	5000
11.03.108.01	19x19	20	6	-	-	5000	-	-	5000
11.03.109.01	20x20	20	6	-	-	5000	-	-	5000
11.03.110.01	21x21	20	6	-	-	5000	-	-	5000
11.03.111.01	22x22	20	6	-	-	5000	-	-	5000

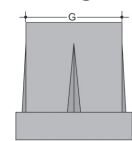
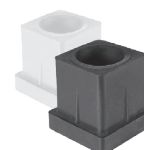

Puntale quadro inclinato 10° alettato a zoccolo in PE / *Inclined ribbed square insert 10° in PE*

QIZ

Codice Code	Testa Head	A	B	C	Nero/Black			Bianco/White		
					€	Pz x conf Pcs/box-bag	Lotto min Min order	€	Pz x conf Pcs/box-bag	Lotto min Min order
11.03.170.02	15x15	15	7	5	-	5000	5000	-	5000	5000

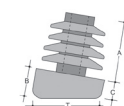

Puntali quadrati filettati e alettati in PP / *Threaded square ribbed insert in PP*

QAF

Codice Code	Testa Head	A	B	Nero/Black-fil. M8 Screw thread M8 Non usare per le rotelle Not to use with castors			Nero/Black-fil. M10 Screw thread M10 Non usare per le rotelle Not to use with castors		
				€	Pz x conf Pcs/box-bag	Lotto min Min order	€	Pz x conf Pcs/box-bag	Lotto min Min order
11.03.151.02	15x15	18	5	-	1000	5000	-	-	-
11.03.152.02	16x16	18	5	-	1000	5000	-	1000	5000
11.03.153.02	18x18	18	5	-	1000	5000	-	1000	5000
11.03.154.02	20x20	18	5	-	1000	1000	-	1000	1000
11.03.155.02	22x22	18	5	-	1000	5000	-	1000	5000
11.03.156.02	25x25	19	5	-	1000	1000	-	1000	1000
11.03.157.02	30x30	20	6	-	1000	1000	-	1000	1000
11.03.158.02	35x35	21	6	-	500	500	-	500	500
11.03.159.02	40x40	22	6	-	500	500	-	500	500
11.03.160.02	50x50	30	7	-	250	250	-	250	250
11.03.163.02	60x60	25	7	-	250	1000	-	250	250
11.03.162.02	80x80	30	8	-	250	1000	-	250	250

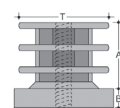

Da non usare per le rotelle  
Not to use with castors

## 04 - COPRITESTA QUADRI / TUBE COVER SQUARE INSERTS

### CQI

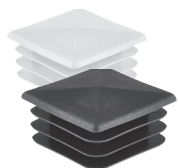

#### Copritesta quadri in PE / Square inserts in PE

Codice Code	Testa Head	A	B	Nero/Black			Bianco/White		
				€	Pz x conf Pcs/box-bag	Lotto min Min order	€	Pz x conf Pcs/box-bag	Lotto min Min order
11.03.174.02	12x12	9	3	-	5000	5000	-	5000	10000
11.03.175.02	14x14	10	3	-	5000	5000	-	5000	10000
11.03.173.02	15x15	11	3	-	5000	5000	-	5000	10000
11.03.176.02	16x16	10	3	-	5000	5000	-	5000	10000
11.03.177.02	18x18	10	3	-	5000	5000	-	5000	10000
11.03.178.02	20x20	11	4	-	4000	4000	-	4000	4000
11.03.179.02	25x25	15	5	-	3000	3000	-	3000	3000
11.03.180.02	30x30	15	5	-	2000	2000	-	2000	2000
11.03.181.02	35x35	15	4	-	1500	1500	-	1500	1500
11.03.182.02	40x40	16	4	-	1500	1500	-	1500	1500
11.03.183.02	50x50	20	5	-	750	750	-	750	750
11.03.184.02	60x60	24	7	-	400	400	-	400	400

### ITSQ

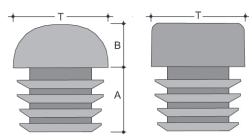
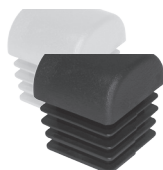

#### Puntale-Copritesta quadro con testa tonda / Square cover cap with round top

Codice Code	Testa Head	A	B	Nero/Black			Bianco/White		
				€	Pz x conf Pcs/box-bag	Lotto min Min order	€	Pz x conf Pcs/box-bag	Lotto min Min order
11.03.261.02	15x15	15	8	-	5000	5000	-	5000	5000
11.03.262.02	18x18	16	8	-	5000	10000	-	5000	10000
11.03.263.02	20x20	19	9	-	4000	4000	-	4000	4000
11.03.264.02	22x22	18	11	-	2500	2500	-	2500	5000
11.03.265.02	25x25	19	12	-	2000	2000	-	2000	4000

### CQM

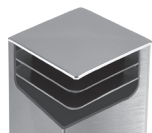
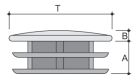
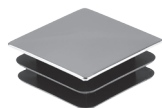

#### Copritesta in PE con testa in FE cromato / Square inserts in PE with metal top

Codice Code	Testa Head	A	B	Cromato/Chrome Plated		
				€	Pz x conf Pcs/box-bag	Lotto min Min order
11.03.243.52	16x16	9	2	-	1000	1000
11.03.244.52	18x18	9	2	-	1000	1000
11.03.245.52	20x20	10	2	-	1000	1000
11.03.246.52	25x25	10	2	-	500	1000
11.03.247.52	30x30	10	3	-	500	1000
11.03.248.52	35x35	12	3	-	250	1000
11.03.249.52	40x40	12	3	-	250	1000

## Copritesta quadri in ABS / Square insert in ABS

Codice Code	Testa Head	S.T.	A	B	Nero/Black			Cromato/Chrome Plated			Dorato (oro galvanico) Gold Plated (galvanic gold)		
					€	Pz x conf Pcs/box-bag	Lotto min Min order	€	Pz x conf Pcs/box-bag	Lotto min Min order	€	Pz x conf Pcs/box-bag	Lotto min Min order
21.03.196.00	12x12	1	7	2	-	1000	3000	-	1000	3000	-	1000	3000
21.03.197.00	12x12	1.2	7	2	-	1000	3000	-	1000	3000	-	1000	3000

CGQ

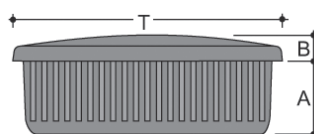
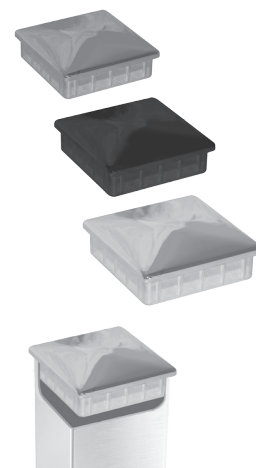

## Copritesta galvanizzati quadri in ABS / Square inserts in ABS

Codice Code	Testa Head	S.T.	A	B	Nero/Black			Cromato/Chrome Plated		
					€	Pz x conf Pcs/box-bag	Lotto min Min order	€	Pz x conf Pcs/box-bag	Lotto min Min order
21.03.198.00	15x15	1	8,5	2,5	-	1000	2000	-	1000	2000
21.03.202.00	15x15	1,2	8,5	2,5	-	1000	2000	-	1000	2000
21.03.205.00	15x15	1,5	8,5	2,5	-	1000	2000	-	1000	2000
21.03.207.00	16x16	1	8	3	-	1000	2000	-	1000	2000
21.03.199.00	16x16	1,5	8	3	-	1000	2000	-	1000	2000
21.03.191.00	18x18	1,2	8	3	-	500	2000	-	500	2000
21.03.192.00	18x18	1,5	8	3	-	500	2000	-	500	2000
21.03.212.00	20x20	1	7	3	-	500	1500	-	500	1500
21.03.213.00	20x20	1,2	7	3	-	500	1500	-	500	1500
21.03.193.00	20x20	1,5	7	3	-	500	1500	-	500	1500
21.03.215.00	25x25	1	7	3	-	250	1000	-	250	1000
21.03.216.00	25x25	1,2	7	3	-	250	1000	-	250	1000
21.03.194.00	25x25	1,5	7	3	-	250	1000	-	250	1000
21.03.217.00	25x25	2	7	3	-	250	1000	-	250	1000
21.03.218.00	30x30	1	10	4	-	200	1000	-	200	1000
21.03.219.00	30x30	1,2	10	4	-	200	1000	-	200	1000
21.03.195.00	30x30	1,5	10	4	-	200	1000	-	200	1000
21.03.222.00	35x35	1,2	11	4	-	200	600	-	200	600
21.03.200.00	35x35	1,5	11	4	-	200	600	-	200	600
21.03.225.00	40x40	1,2	11	4	-	100	200	-	100	200
21.03.201.00	40x40	1,5	11	4	-	100	200	-	100	200
21.03.189.00	45x45	1,2	11	5	-	100	100	-	100	100
21.03.190.00	45x45	1,5	11	5	-	100	100	-	100	100
21.03.228.00	50x50	1,2	11	5	-	100	100	-	100	100
21.03.229.00	50x50	1,5	11	5	-	100	100	-	100	100
21.03.232.00	60x60	1,2	12	5	-	100	100	-	100	100
21.03.233.00	60x60	1,5	12	5	-	100	100	-	100	100
21.03.236.00	80x80	1,2	12	5	-	50	200	-	50	200
21.03.237.00	80x80	1,5	12	5	-	50	200	-	50	200
21.03.238.00	80x80	2	12	5	-	50	200	-	50	200

CGQ

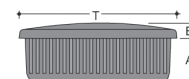

# 05 - PUNTALI RETTANGOLARI / RECTANGULAR TUBE INSERTS

## RIA

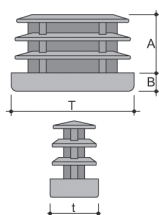

### Puntali rettangolari alettati in PE / Rectangular ribbed insert in PE

Codice Code	Testa Head	A	B	Nero/Black			Bianco/White		
				€	Pz x conf Pcs/box-bag	Lotto min Min order	€	Pz x conf Pcs/box-bag	Lotto min Min order
11.04.100.02	10x15	11	5	-	3000	3000	-	3000	12000
11.04.101.02	10x20	15	5	-	3000	3000	-	3000	12000
11.04.102.02	10x25	15	5	-	2500	2500	-	2500	10000
11.04.103.02	10x30	15	5	-	2500	2500	-	2500	10000
11.04.098.02	10x35	16.5	5	-	2000	10000	-	2000	10000
11.04.099.02	10x50	17	5	-	2000	2000	-	2000	10000
11.04.115.02	10x40	15	5	-	2000	2000	-	2000	10000
11.04.104.02	15x20	12	5	-	2000	2000	-	2000	10000
11.04.105.02	15x25	17	5	-	2000	2000	-	2000	10000
11.04.106.02	15x30	12	5	-	5000	5000	-	5000	10000
11.04.107.02	15x35	18	6	-	1500	1500	-	1500	12000
11.04.108.02	15x40	18	6	-	1000	1000	-	1000	10000
11.04.123.02	15x50	15	5	-	1000	1000	-	1000	10000
11.04.283.02	15x60	17	5	-	1000	1000	-	1000	10000
11.04.121.02	20x25	12	5	-	2000	6000	-	2000	6000
11.04.109.02	20x30	17	5	-	2500	2500	-	2500	5000
11.04.110.02	20x35	17	5	-	2500	2500	-	2500	5000
11.04.111.02	20x40	17	5	-	2500	2500	-	2500	5000
11.04.112.02	20x50	17	5	-	1500	1500	-	1500	6000
11.04.113.02	20x60	17	5	-	1000	1000	-	1000	5000
11.04.282.02	20x100	23	6	-	750	750	-	750	1500
11.04.285.02	25x30	17	5	-	3000	6000	-	3000	12000
11.04.114.02	25x35	19	6	-	1000	1000	-	1000	5000
11.04.118.02	25x40	18	6	-	1000	1000	-	1000	5000
11.04.116.02	25x50	21	6	-	1250	1250	-	1250	5000
11.04.120.02	30x40	18	6	-	1000	1000	-	1000	3000
11.04.126.02	30x45	18	6	-	1000	3000	-	1000	3000
11.04.117.02	30x50	18	6	-	1000	1000	-	1000	3000
11.04.119.02	30x60	21	6	-	1000	1000	-	1000	3000
11.04.280.02	30x70	17	6	-	750	750	-	750	1500
11.04.281.02	30x80	17	6	-	750	750	-	750	1500
11.04.127.02	40x60	17	6	-	750	750	-	750	1500
11.04.284.02	40x70	18	6	-	500	500	-	500	1000
11.04.122.02	40x80	23	6	-	450	450	-	450	900
11.04.128.02	40x100	23	6	-	400	400	-	400	800
11.04.129.02	50x100	23	6	-	300	300	-	300	900
11.04.287.02	60x80	22	6	-	200	200	-	200	800
11.04.286.02	60x120	22	6	-	200	200	-	200	800

## CRI



### Copritesta/puntali rettangolari alettati in PE / Ribbed rectangular insert in PE

Codice Code	Testa Head	A	B	Nero/Black			Bianco/White		
				€	Pz x conf Pcs/box-bag	Lotto min Min order	€	Pz x conf Pcs/box-bag	Lotto min Min order
11.04.145.02	20x80	16	3	-	1000	1000	-	1000	5000
11.04.146.02	25x100	15	3	-	600	600	-	600	3000
11.04.147.02	30x100	16	3	-	500	500	-	500	3000
11.04.150.02	20x120	19	5,5	-	500	500	-	500	1000

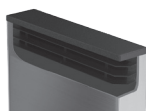
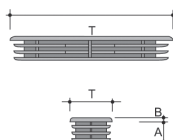

Puntali rettangolari alettati inclinati in PE / *Inclined ribbed rectangular insert in PE*

RAI

Codice Code	Testa Head	Inclin Inclinat	A	B	Nero/Black			Bianco/White		
					€	Pz x conf Pcs/box-bag	Lotto min Min order	€	Pz x conf Pcs/box-bag	Lotto min Min order
11.04.184.02	15x30	15°	17	5	-	4000	4000	-	4000	4000
11.04.183.02	20x30	20°	18	6	-	2500	5000	-	2500	5000
11-04-181-02	15x30	30°	18	6	-	5000	5000	-	5000	5000
11-04-182-02	20x40	30°	19	6	-	1700	3400	-	1700	3400

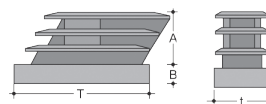
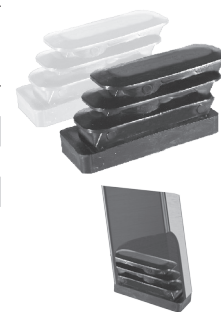

Puntali rett. inclinato 30° alettati a zoccolo in PE  
*Inclined ribbed rectangular insert 30° in PE*

RIZ

Codice Code	Testa Head	A	B	C	Nero/Black			Bianco/White		
					€	Pz x conf Pcs/box-bag	Lotto min Min order	€	Pz x conf Pcs/box-bag	Lotto min Min order
11.04.190.02	15x30	22	22	5	-	2500	5000	-	2500	5000

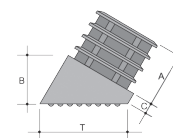
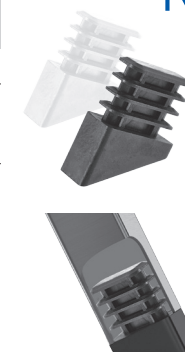

Puntale rettangolare sagomato in PE - *Rectangular shaped insert in PE*

RIAS

Codice Code	Testa Head	A	B	Nero/Black		
				€	Pz x conf Pcs/box-bag	Lotto min Min order
11.04.270.02	30x20	25	25	-	1000	1000

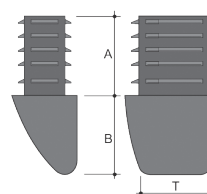

Puntali rettangolari alettati e filettati in PP / *Threaded and ribbed insert in PP*

RAF

Codice Code	Testa Head	A	B	Nero M8 / Black M8			Nero M10 / Black M10		
				€	Pz x conf Pcs/box-bag	Lotto min Min order	€	Pz x conf Pcs/box-bag	Lotto min Min order
11.04.165.02	20x30	19	6	-	1000	3000	-	1000	1000
11.04.166.02	20x35	19	6	-	1000	5000	-	1000	5000
11.04.167.02	20x40	19	6	-	1000	1000	-	1000	1000
11.04.168.02	20x50	19	6	-	500	5000	-	500	500
11.04.169.02	20x60	19	6	-	500	3000	-	500	1000
11.04.170.02	25x50	22	6	-	500	500	-	500	500
11.04.172.02	30x50	22	6	/	/	/	-	500	1000
11.04.171.02	30x60	22	6	-	500	3000	-	500	3000

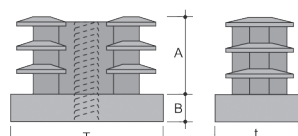

Filetto M8 - M10  
Misure riferite all'esterno del tubo - Da non usare per le rotelle  
Thread M8 - M10  
Sizes referred to external tube - Not to use with castors

# RAFI

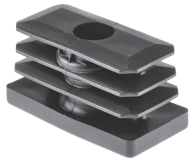

## Puntali rettangolari in PP con inserto filettato in ferro Square inserts in PP with iron thread

Codice Code	Testa Head	A	B	C	Ø	Nero/Black		
						€	Pz x conf Pcs/box-bag	Lotto min Min order
11.04.250.73	25x50	22	6	M10	11	-	500	500

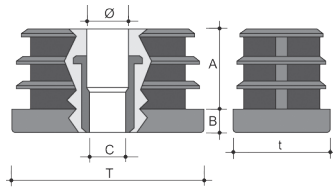

# 06 - COPRITESTA RETTANGOLARI / RECTANGULAR TUBE INSERTS

# CRI

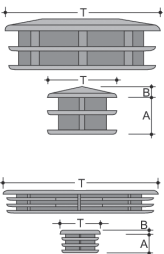
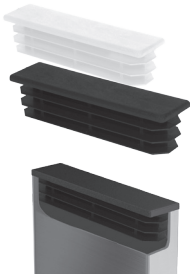

(\*) Le misure indicate sono con testa piana e possono essere usate come puntali.  
These items have flat head and can be used as inserts

## Copritesta rettangolari alettati in PE / Rectangular tube cover inserts in PE

Codice Code	Testa Head	A	B	Nero/Black			Bianco/White		
				€	Pz x conf Pcs/box-bag	Lotto min Min order	€	Pz x conf Pcs/box-bag	Lotto min Min order
11.04.130.02	10x15	9	3,0	-	4000	4000	-	4000	12000
11.04.131.02	10x20	9	3,0	-	4000	4000	-	4000	12000
11.04.144.02	10x30	9	3,0	-	2500	2500	-	2500	10000
11.04.132.02	10x40	10	3,0	-	2500	2500	-	2500	10000
11.04.134.02	15x20	10	3,5	-	3000	3000	-	3000	12000
11.04.133.02	15x25	10	3,5	-	3000	3000	-	3000	12000
11.04.135.02	15x30	10	3,5	-	3000	3000	-	3000	12000
11.04.136.02	15x35	10	3,5	-	2500	2500	-	2500	10000
11.04.137.02	15x40	10	3,5	-	2000	2000	-	2000	10000
11.04.138.02	20x30	10	4,0	-	4000	4000	-	4000	4000
11.04.139.02	20x35	10	4,0	-	4000	4000	-	4000	12000
11.04.140.02	20x40	11	4,0	-	2000	2000	-	2000	2000
11.04.145.02	20x80 (*)	16	3,0	-	1000	1000	-	1000	5000
11.04.143.02	25x40	12	4,0	-	2000	2000	-	2000	6000
11.04.141.02	25x50	12	4,0	-	1500	1500	-	1500	6000
11.04.146.02	25x100 (*)	15	3,0	-	600	600	-	600	3000
11.04.148.02	30x40	13	5,0	-	1500	1500	-	1500	3000
11.04.142.02	30x50	13	5,0	-	1500	1500	-	1500	3000
11.04.149.02	30x60	19	5,0	-	1200	1200	-	1200	2400
11.04.147.02	30x100 (*)	16	3,0	-	500	500	-	500	3000
11.04.150.02	20x120 (*)	19	5,5	-	500	500	-	500	1000

# CRIS



## Copritesta destro e sinistro per stagge/ Cover tube left and right for levelling staves

Codice Code	Testa Head	A	B	Nero/Black			
				€	Pz x conf Pcs/box-bag	Lotto min Min order	
11.04.176.02	Destro Right	18x90	15	3	-	1000	1000
11.04.177.02*	Sinistro Left	18x90	15	3	-	1000	1000

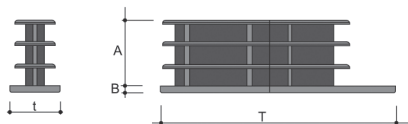

Copritesta in PP estetici rettangolari / Rectangular cover tube in PP

CRIE

Codice Code	Testa Head	A	B	C	D	Nero/Black		
						€	Pz x conf Pcs/box-bag	Lotto min Min order
11.04.156.02	40x80	15	11	76	36	-	500	500

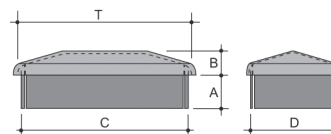

Copritesta in PE rettangolare con testa in FE / Chrome rectangular inserts

CRTM

Codice Code	Testa Head	A	B	Cromato/Chrome plated		
				€	Pz x conf Pcs/box-bag	Lotto min Min order
11.04.260.52	10x20	10	1,5	-	1000	2000
11.04.261.52	15x20	10	2,0	-	1000	1000
11.04.263.52	15x30	10	2,0	-	1000	1000
11.04.262.52	20x40	11	2,0	-	500	1000

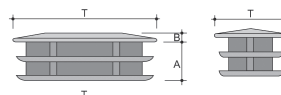

Copritesta rettangolari in ABS - nero - cromato metallizzato ottone  
Rectangular insert in ABS - black - chrome brass plated

CRG

Codice Code	Testa Head	S.T	A	B	Nero/Black			Cromato/Chrome plated		
					€	Pz x conf Pcs/box-bag	Lotto min Min order	€	Pz x conf Pcs/box-bag	Lotto min Min order
21.04.239.00	8x15	1,0	8	2,0	-	1000	2000	-	1000	2000
21.04.202.00	10x15	1,0	9	1,0	-	1000	2000	-	1000	2000
21.04.207.00	10x15	1,2	9	2,5	-	1000	2000	-	1000	2000
21.04.216.00	10x20	1,0	9	2,5	-	1000	2000	-	1000	2000
21.04.217.00	10x20	1,2	9	2,5	-	1000	2000	-	1000	2000
21.04.221.00	10x25	1,5	9	2,5	-	1000	2000	-	1000	2000
21.04.224.00	10x30	1,5	9	2,5	-	500	2000	-	500	2000
21.04.208.00	10x40	1,2	9	3,0	-	500	1000	-	500	1000
21.04.203.00	10x40	1,5	9	3,0	-	500	1000	-	500	1000
21.04.200.00	15x20	1,2	9	3,0	-	1000	1000	-	1000	1000
21.04.201.00	15x20	1,5	9	3,0	-	1000	1000	-	1000	1000
21.04.229.00	15x25	1,5	9	3,0	-	500	500	-	500	500
21.04.209.00	15x30	1,2	9	3,0	-	500	500	-	500	500
21.04.204.00	15x30	1,5	9	3,0	-	500	500	-	500	500
21.04.233.00	15x35	1,5	9	3,0	-	250	500	-	250	500
21.04.234.00	15x40	1,0	9	3,0	-	250	500	-	250	500
21.04.210.00	15x40	1,2	9	3,0	-	250	500	-	250	500
21.04.205.00	15x40	1,5	9	3,0	-	250	500	-	250	500
21.04.212.00	20x30	1,2	9	3,0	-	500	500	-	500	500
21.04.211.00	20x30	1,5	9	3,0	-	500	500	-	500	500
21.04.214.00	20x35	1,5	9	3,0	-	250	500	-	250	500
21.04.213.00	20x40	1,2	9	3,5	-	250	500	-	250	500
21.04.206.00	20x40	1,5	9	3,5	-	250	500	-	250	500
21.04.244.00	20x40	2,0	9	3,5	-	250	500	-	250	500
21.04.241.00	20x50	1,2	10	3,0	-	200	600	-	200	600
21.04.242.00	20x50	1,5	10	3,0	-	200	600	-	200	600
21.04.240.00	20x60	1,5	10	3,0	-	200	600	-	200	600

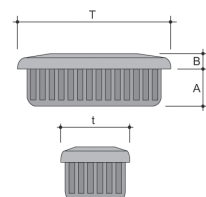

# 07 - PUNALI A ELLISSE OVALI / ELLIPTICAL AND OVAL INSERTS

## EIA

### Puntali a ellisse alettati in PE / Ribbed elliptical insert in PE



Codice Code	Testa Head	A	B	Nero/Black			Bianco/White		
				€	Pz x conf Pcs/box-bag	Lotto min Min order	€	Pz x conf Pcs/box-bag	Lotto min Min order
11.05.101.02	20x40	18	6	-	2500	5000	-	2500	5000
11.05.100.02	15x30	14	4	-	6000	6000	-	10000	10000
11.05.099.02	30x60	19	5	-	1500	1500	-	1500	3000
11.05.098.02	34x18	16	5	-	5000	5000	-	5000	5000

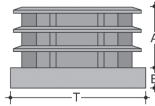

## EIAS

### Puntali a ellisse in PE / Ribbed elliptical insert in PE



Codice Code	Testa Head	A	B	Nero/Black		
				€	Pz x conf Pcs/box-bag	Lotto min Min order
11.05.190.02	30x60	15	5	-	1000	1000

## EIAI

### Puntali a ellisse inclinati 10° in PE / Elliptical inclined ribbed insert 10° in PE

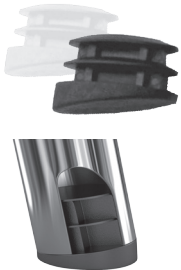

Codice Code	Testa Head	A	B	C	Nero/Black			Bianco/White		
					€	Pz x conf Pcs/box-bag	Lotto min Min order	€	Pz x conf Pcs/box-bag	Lotto min Min order
11.05.120.02	15x30	12	2	7	-	6000	12000	-	6000	12000

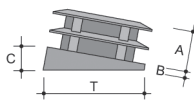

## EIAD

### Puntali a ellisse alettati in PE / Ribbed elliptical insert in PE



Codice Code	Testa Head	A	B	Nero/Black		
				€	Pz x conf Pcs/box-bag	Lotto min Min order
21.05.102.00	15x30	16	4	-	6000	6000

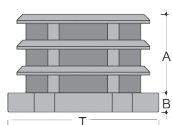

Base c/ sporgenza da 1 lato per distanziare. Misure riferite all'esterno del tubo  
Base with one side spacer. Sizes referred to external tube

Puntali a ellisse inclinati 15° in PE / Elliptical inclined 15°ribbed insert in PE

EIADI

Codice Code	Testa Head	A	B	C	Nero/Black			Bianco/White		
					€	Pz x conf Pcs/box-bag	Lotto min Min order	€	Pz x conf Pcs/box-bag	Lotto min Min order
11.05.185.02	15x30	21	9	4	-	3000	3000	-	3000	6000

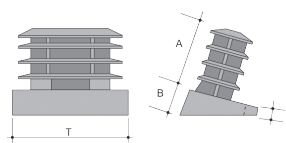

Puntali ovali alettati in PE / Ribbed oval insert in PE

OIA

Codice Code	Testa Head	A	B	Nero/Black			Bianco/White		
				€	Pz x conf Pcs/box-bag	Lotto min Min order	€	Pz x conf Pcs/box-bag	Lotto min Min order
11.05.109.02	12x25	12,5	5	-	2000	6000	-	2000	6000
11.05.114.02	15x30	17	5	-	5000	5000	-	5000	5000
11.05.112.02	18x36	18	6	-	2500	2500	-	2500	5000
11.05.113.02	20x40	19	6	-	2000	2000	-	2000	6000
11.05.110.02	25x50	17	5	-	2000	2000	-	2000	6000
11.05.111.02	30x60	18	5	-	1250	1250	-	1250	2500

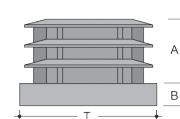

Puntale alettato inclinato 15° in PE / Inclined 15° ribbed oval insert in PE

OIADI

Codice Code	Testa Head	A	B	C	Nero/Black			Bianco/White		
					€	Pz x conf Pcs/box-bag	Lotto min Min order	€	Pz x conf Pcs/box-bag	Lotto min Min order
11.05.200.02	15x30	21	9	4	-	3000	6000	-	3000	6000

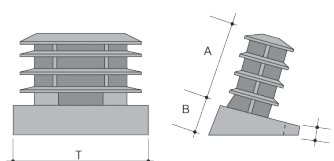

Puntale alettato inclinato in PE / Inclined ribbed oval insert in PE

OIAS

Codice Code	A	B	C	D	E	Nero/Black			Bianco/White		
						€	Pz x conf Pcs/box-bag	Lotto min Min order	€	Pz x conf Pcs/box-bag	Lotto min Min order
11.05.116.02	34	19,3	5	16,5	27,5	-	3500	3500	-	3500	10500

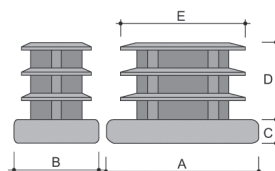

## PIO



### Puntali ovali inclinati 12,5° in PE / *Inclined ribbed oval insert 12,5° in PE*

Codice Code	A	B	C	D	E	Nero/Black			Bianco/White		
						€	Pz x conf Pcs/box-bag	Lotto min Min order	€	Pz x conf Pcs/box-bag	Lotto min Min order
11.05.178.02	30	15	13	7	11	-	1000	1000	-	1000	5000

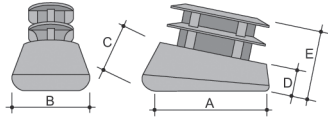

## PIO



### Puntali ovali inclinati alla base 20° e gambo 30° - PE *Ribbed oval insert inclined bottom 20° leg 30° - PE*

Codice Code	A	B	C	D	E	Nero/Black			Bianco/White		
						€	Pz x conf Pcs/box-bag	Lotto min Min order	€	Pz x conf Pcs/box-bag	Lotto min Min order
11.05.179.02	30	15	9	4	11	-	2000	2000	-	2000	6000

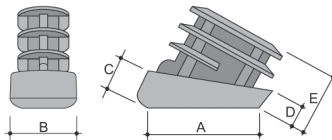

## OAF



### Puntali ovali alettati filettati in PP / *Ribbed oval threaded insert in PP*

Codice Code	Testa Head	A	B	Nero M10 / Black M10		
				€	Pz x conf Pcs/box-bag	Lotto min Min order
11.05.118.02	18x36	15	6,5	-	500	5000
11.05.119.02	20x40	18	6,5	-	500	500

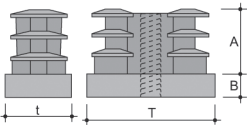

Filetto 10 MA - Misure riferite all'esterno del tubo - Da non usare per le rotelle  
Thread 10 MA - Sizes referred to external tube - Not to use with castors

## PCSO



### Puntali copritesta semiovali in PE / *Ribbed half-oval insert in PE*

Codice Code	Testa Head	A	B	Nero/Black			Bianco/White		
				€	Pz x conf Pcs/box-bag	Lotto min Min order	€	Pz x conf Pcs/box-bag	Lotto min Min order
11.06.107.02	15x30	12	3,0	-	2000	2000	-	2000	10000
11.06.113.02	20x40	13	3,5	-	1500	1500	-	1500	10500
11.06.118.02	25x40	13	3,5	-	2000	2000	-	2000	10000

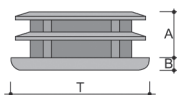

Copritesta in PE ovale con testa in FE cromato  
Ribbed oval insert in PE with metal top

COM

Codice Code	Testa Head	A	B	Cromato/Chrome plated		
				€	Pz x conf Pcs/box-bag	Lotto min Min order
11.05.168.52	10x20	10	2,0	-	1000	3000
11.05.165.52	15x30	10	2,5	-	1000	3000
11.05.167.52	18x36	11	3,0	-	500	2000
11.05.166.52	20x40	10	3,0	-	500	2000

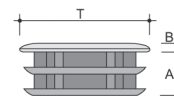

Copritesta a ellisse in PE / Ribbed elliptical insert in PE

CEI

Codice Code	Testa Head	A	B	Nero/Black			Bianco/White		
				€	Pz x conf Pcs/box-bag	Lotto min Min order	€	Pz x conf Pcs/box-bag	Lotto min Min order
11.05.105.02	15x30	10	3,0	-	2000	2000	-	2000	6000
11.05.106.02	18x36	10	3,5	-	2000	6000	-	2000	6000
11.05.108.02	20x35	11	5,0	-	2500	2500	-	2500	5000
11.05.107.02	20x40	11	4,0	-	2000	2000	-	2000	6000

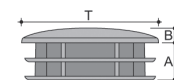

Copritesta a ellisse in PE / Ribbed elliptical insert in PE

CEIS

Codice Code	Testa Head	A	B	Nero/Black		
				€	Pz x conf Pcs/box-bag	Lotto min Min order
21.05.195.00	30x60	15	10	-	1000	3000

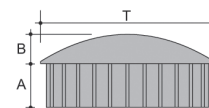

Copritesta ovali in ABS - nero - cromato metallizzato  
Oval insert in ABS black - chrome plated

COC

Codice Code	Testa Head	S.T.	A	B	Nero/Black			Cromato Metallizzato Chromed plated Brass metallized		
					€	Pz x conf Pcs/box-bag	Lotto min Min order	€	Pz x conf Pcs/box-bag	Lotto min Min order
21.05.139.00	10x20	1,0	9	2,5	-	1000	3000	-	1000	3000
21.05.140.00	10x20	1,2	9	2,5	-	1000	3000	-	1000	3000
21.05.144.00	10x25	1,5	9	3,0	-	1000	3000	-	1000	3000
21.05.147.00	15x25	1,5	9	3,0	-	500	3000	-	500	3000
21.05.134.00	15x30	1,2	10	3,0	-	500	2000	-	500	2000
21.05.132.00	15x30	1,5	10	3,0	-	500	2000	-	500	2000
21.05.135.00	20x30	1,2	10	3,0	-	500	1000	-	500	1000
21.05.133.00	20x30	1,5	10	3,0	-	500	1000	-	500	1000
21.05.136.00	20x35	1,5	10	3,0	-	250	1000	-	250	1000
21.05.159.00	20x40	1,5	10	3,0	-	250	1000	-	250	1000
21.05.137.00	16x32	1,2	10	3,0	-	500	500	-	500	500
21.05.138.00	17x45	1,5	10	3,0	-	250	250	-	250	250

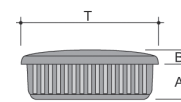

## COI



### Copritesta ovali alettati in PE / Ribbed oval insert in PE

Codice Code	Testa Head	A	B	Nero/Black			Bianco/White		
				€	Pz x conf Pcs/box-bag	Lotto min Min order	€	Pz x conf Pcs/box-bag	Lotto min Min order
11.05.124.02	10x20	10	2	-	5000	5000	-	5000	5000
11.05.125.02	15x30	10	3	-	7500	7500	-	7500	7500
11.05.126.02	18x36	10	3	-	2500	2500	-	2500	5000
11.05.127.02	20x40	10	4	-	3000	3000	-	3000	6000
11.05.129.02	25x50	17	5	-	2000	2000	-	2000	6000
11.05.128.02	30x60	22,5	3	-	1500	1500	-	1500	6000

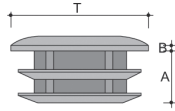

## CPTA



### Copritesta o puntali ovali testa alta in PE / Ribbed oval insert large head in PE

Codice Code	A	B	C	D	Nero/Black			Bianco/White		
					€	Pz x conf Pcs/box-bag	Lotto min Min order	€	Pz x conf Pcs/box-bag	Lotto min Min order
11.05.171.02	30	15	8	12	-	2000	2000	-	2000	6000

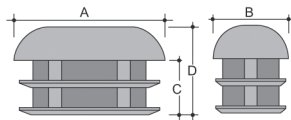

## CPTA1



### Copritesta ovali testa alta 1 aletta in PE / One rib oval insert in PE

Codice Code	A	B	C	D	Nero/Black			Bianco/White		
					€	Pz x conf Pcs/box-bag	Lotto min Min order	€	Pz x conf Pcs/box-bag	Lotto min Min order
11.05.174.02	32	15	5	7,6	-	5000	5000	-	5000	5000

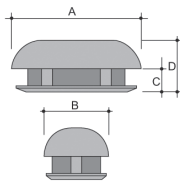

## CONI



### Copritesta ovale per tubo ovale / Oval cover cap for oval tube

Codice Code	A	B	C	D	Nero/Black		
					€	Pz x conf Pcs/box-bag	Lotto min Min order
11.05.180.02	32	15	28	36	-	40	400

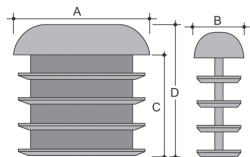

Copritesta ovale per tubo ellittico / Oval cover cap for elliptical tube

Codice Code	A	B	C	D	Nero/Black		
					€	Pz x conf Pcs/box-bag	Lotto min Min order
11.05.181.02	32	15	28	36	-	-	5000

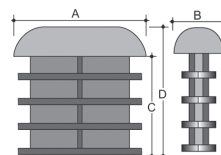

CENI



08 - BASI PIANE A PINZA PER TELAI FILO/ CLIPS FOR CHAIR WIRE METAL FRAMES

Base piana a pinza in PE per tondo 8 mm  
Clip for chair wire metal frame for tube 8 mm

Codice Code	Base	A	B	C	Nero/Black			Neutro/ Neutral		
					€	Pz x conf Pcs/box-bag	Lotto min Min order	€	Pz x conf Pcs/box-bag	Lotto min Min order
11.06.122.02	17x24	12,5	24	17	-	5000	5000	-	5000	20000

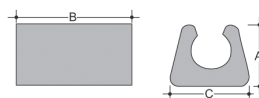

BPP



Base piana a pinza in PE per tondo 10 mm  
Clip for chair wire metal frame for tube 10 mm

Codice Code	Base	A	B	C	Nero/Black			Bianco/White			Neutro/ Neutral		
					€	Pz x conf Pcs/box-bag	Lotto min Min order	€	Pz x conf Pcs/box-bag	Lotto min Min order	€	Pz x conf Pcs/box-bag	Lotto min Min order
11.06.120.02	19x30	14,5	29,5	19	-	5000	5000	-	5000	10000	-	5000	10000

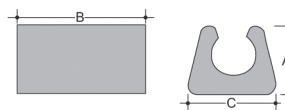

BPP



Base piana a pinza in PE per tondo 12 mm  
Clip for chair wire metal frame for tube 12 mm

Codice Code	Base	A	B	C	Neutro /Neutral		
					€	Pz x conf Pcs/box-bag	Lotto min Min order
11.06.123.02	22x31	16,5	31	22	-	2500	2500

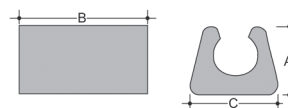

BPP



## BPP



Base piana a pinza in PE per tondo 14 / *Clip for chair wire metal for tube 14 mm*

Codice Code	Base	A	B	C	Nero/Black			Neutro/ Neutral		
					€	Pz x conf Pcs/box- bag	Lotto min Min order	€	Pz x conf Pcs/box- bag	Lotto min Min order
11.06.124.02	24x33	18	33	24	-	2500	10000	-	2500	10000

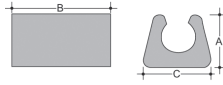

\* Su richiesta: certificato REACH -RoHS2 per PE colore nero con maggiorazione del 25% sul prezzo  
\* On request: REACH -RoHS2 certified with an increase of 25 % on the price -PE black color only .

## BPPA



Base piana a pinza antirotazione in PE per tondo 11  
*Clip for chair wire metal for tube 11 mm non-turning*

Codice Code	Base	A	B	C	D	Neutro / Neutral		
						€	Pz x conf Pcs/box- bag	Lotto min Min order
11.06.130.02	17x24	14	30	17	20	-	5000	5000

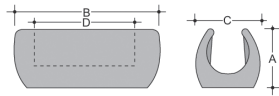

## BPPD



Base piana a pinza antirotazione in PE per tondo 11  
*Clip for chair wire metal for tube 11 mm non-turning*

Codice Code	Base	A	B	C	D	Neutro / Neutral		
						€	Pz x conf Pcs/box- bag	Lotto min Min order
11.06.135.02	35x31	16	31	35	15	-	1500	1500

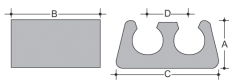

## BTF



Piedini 4 pzi. per telaio a filo neutri / *Set of 4 pcs of neutral glides for wireframes*

Codice Code	A	B	C	D	E	F	G	Neutro/ Neutral		
								€	Pz x conf Pcs/box- bag	Lotto min Min order
11.06.140.02	22	98	16.5	12	5	145°	57	-	100	100

## BTFA



Piedini 4 pzi. con aggancio per telaio a filo neutr  
*Set of 4 pcs of neutral glides with joint for wireframes*

Codice Code	A	B	C	D	E	F	G	H	I	L	M	Neutro/ Neutral		
												€	Pz x conf Pcs/box- bag	Lotto min Min order
11.06.141.02	22	57	16.5	12	5	145°	31	31.5	97	31	31.5	-	100	100

## PPTF



Prolunga per piedini con agganci per telaio a filo neutri (per BTFA)  
*Neutral joint for glides BTFA*

Codice Code	A	B	C	D	Ø	Neutro/ Neutral		
						€	Pz x conf Pcs/box- bag	Lotto min Min order
11.06.142.02	38	57	16.5	12	6	-	100	100

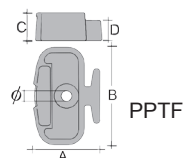
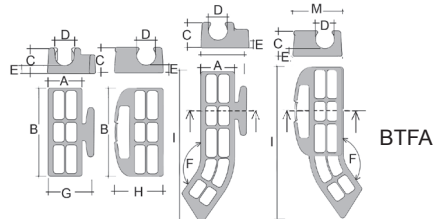
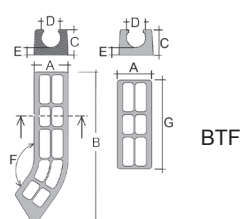

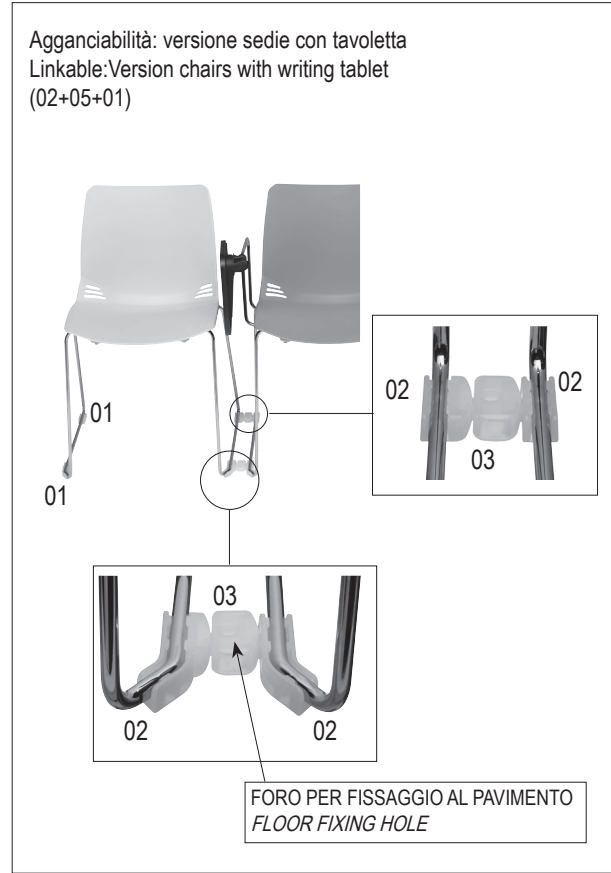
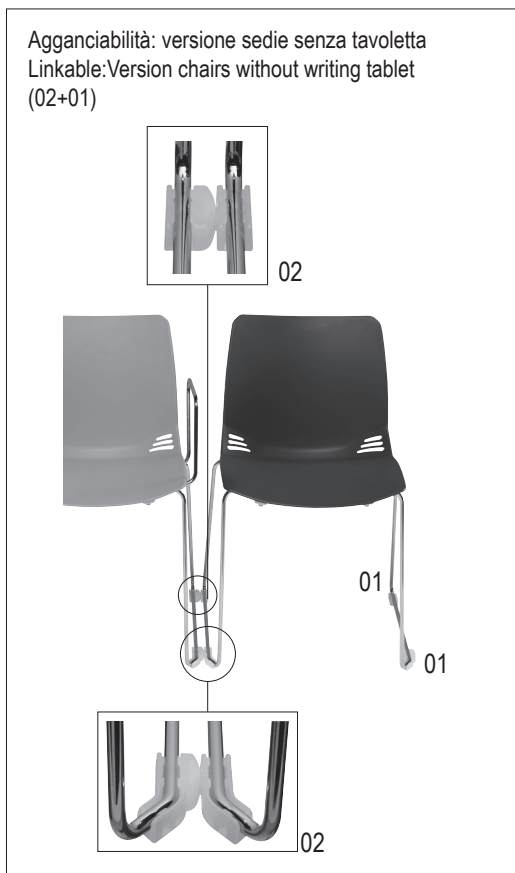
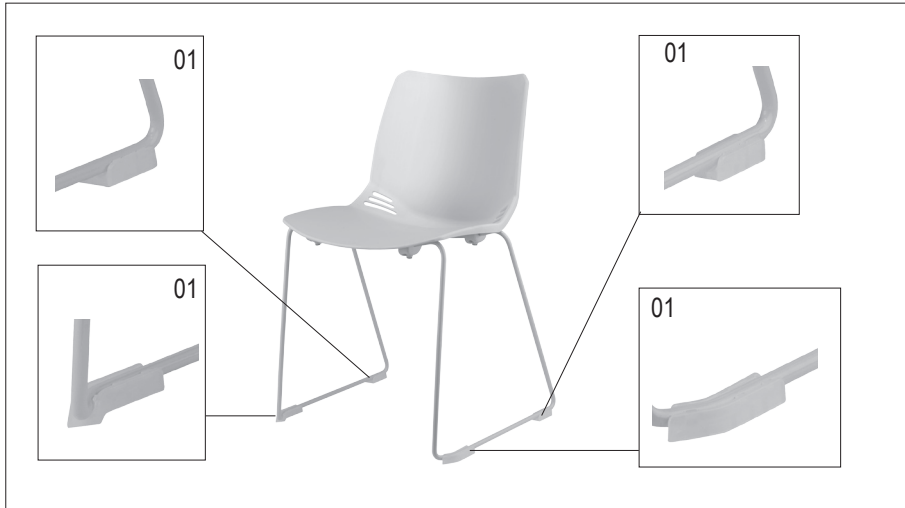

- |    |      |  |       |
|----|------|--|-------|
| 01 | BTF  | Piedini 4 pzi. per telaio a filo neutri<br><i>Set of 4 pcs of neutral glides for wireframes</i>  | pg.34 |
| 02 | BTFA | Piedini 4 pzi. con aggancio per telaio a filo neutri<br><i>Set of 4 pcs of neutral glides with joint for wireframes</i>                            | pg.34 |
| 03 | PPTF | Prolunga per piedini con agganci per telaio a filo neutri per BTFA (Fissaggio al pavimento)<br><i>Neutral joint for glides BTFA (Floor fixing)</i> | pg.34 |

## 09 - PUNTALI PER ESTERNO/ OUTER CAPS

### EX



Puntali export in PVC / Outer caps in PVC

Codice Code	Ø Tubo Ø Tube	A	B	Nero/Black			Bianco/White		
				€	Pz x conf Pcs/box- bag	Lotto min Min order	€	Pz x conf Pcs/box- bag	Lotto min Min order
11.10.124.01	2	7,5	6	-	6000	6000	-	6000	6000
11.10.125.01	3	9.5	8	-	5000	5000	-	5000	30000
11.10.126.01	4	11	9	-	5000	5000	-	5000	5000
11.10.127.01	5	13	10	-	5000	5000	-	5000	5000
11.10.128.01	6	14	11	-	5000	5000	-	5000	5000
11.10.130.01	7	14	11	-	5000	5000	-	5000	10000
11.10.129.01	8	16	13	-	5000	5000	-	5000	5000
11.10.132.01	10	18	14	-	5000	5000	-	5000	5000
11.10.133.01	12	21	17	-	3000	3000	-	3000	6000
11.10.134.01	13	21	17	-	2000	2000	-	2000	10000
11.10.123.01	14	23	18	-	2000	2000	-	2000	2000
11.10.135.01	16	25	20	-	2000	2000	-	2000	2000
11.10.136.01	18	27	22	-	2000	2000	-	2000	2000
11.10.138.01	20	30	24	-	2000	2000	-	2000	2000
11.10.139.01	22	32	26	-	2000	2000	-	2000	2000
11.10.147.01	25	32	29	-	1500	1500	-	1500	1500
11.10.143.01	26	37	31	-	1000	1000	-	1000	1000
11.10.141.01	28	38	32	-	1000	1000	-	1000	1000
11.10.144.01	30	41	34	-	1000	1000	-	1000	1000
11.10.142.01	32	43	39	-	800	800	-	800	800
11.10.145.01	35	47	40	-	500	500	-	500	1000
11.10.160.01	40	33	27	-	1000	1000	-	1000	6000
11.10.161.01	50	33	27	-	500	500	-	500	6000

### EX



Puntali export (misure speciali) in PVC / Outer caps (special sizes) in PVC

Codice Code	Ø Tubo Ø Tube	A	B	Nero/Black			Bianco/White		
				€	Pz x conf Pcs/box- bag	Lotto min Min order	€	Pz x conf Pcs/box- bag	Lotto min Min order
11.10.131.01	9	17	13	-	2000	2000	-	2000	10000
11.10.137.01	19	28	23	-	2000	2000	-	2000	6000
11.10.140.01	24-25	36	30	-	1500	1500	-	1500	1500

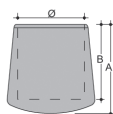

### EC



Puntali a campana in PVC / Outer caps in PVC Misure riferite al Ø esterno del tubo / Sizes referred to Ø external tube

Codice Code	Ø Tubo Ø Tube	A	B	Nero/Black			Bianco/White		
				€	Pz x conf Pcs/box- bag	Lotto min Min order	€	Pz x conf Pcs/box- bag	Lotto min Min order
11.10.201.01	6	20	16	-	2000	4000	-	2000	10000
11.10.202.01	8	23	18	-	1500	1500	-	1500	10500
11.10.203.01	10	25	21	-	1500	1500	-	1500	10500
11.10.204.01	12	27	23	-	1500	1500	-	1500	10500
11.10.205.01	14	28	22	-	1000	1000	-	1000	10000
11.10.206.01	16	29	22	-	1000	1000	-	1000	10000
11.10.207.01	18	31	24	-	1000	1000	-	1000	10000
11.10.208.01	20	33	26	-	1000	1000	-	1000	10000
11.10.209.01	22	35	27	-	1000	1000	-	1000	5000
11.10.210.01	24	35	28	-	1000	1000	-	1000	5000
11.10.211.01	26	37	32	-	500	500	-	500	5000
11.10.212.01	28	41	34	-	500	500	-	500	5000
11.10.213.01	30	44	36	-	500	500	-	500	5000

Puntali bombati lunghi in PVC / Outer caps in PVC

EL

Codice Code	Ø Tubo Ø Tube	A	B	Nero/Black			Bianco/White		
				€	Pz x conf Pcs/box- bag	Lotto min Min order	€	Pz x conf Pcs/box- bag	Lotto min Min order
11.10.231.01	10	28	22	-	4000	4000	-	4000	4000
11.10.232.01	12	31	24	-	4000	4000	-	4000	4000
11.10.233.01	14	34	27	-	2000	4000	-	2000	4000
11.10.234.01	16	36	29	-	2000	2000	-	2000	4000
11.10.235.01	18	38	31	-	2000	2000	-	2000	4000
11.10.236.01	20	40	33	-	1500	3000	-	1500	4500

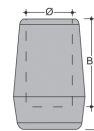

Puntali a botte in PVC / Outer caps in PVC

EB

Codice Code	Ø Tubo Ø Tube	A	B	Nero/Black			Bianco/White		
				€	Pz x conf Pcs/box- bag	Lotto min Min order	€	Pz x conf Pcs/box- bag	Lotto min Min order
11.10.220.01	6	19	14	-	4000	4000	-	4000	12000
11.10.221.01	8	21	16	-	4000	4000	-	4000	12000
11.10.222.01	10	23	18	-	5000	10000	-	5000	10000
11.10.223.01	12	26	20	-	2500	10000	-	2500	10000
11.10.224.01	14	28	21	-	2500	10000	-	2500	10000
11.10.225.01	16	30	23	-	2500	10000	-	2500	10000
11.10.226.01	18	31	24	-	2500	10000	-	2500	10000

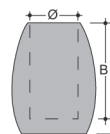

Puntale esterno leggero in PE / Light outer caps in PE

ETL

Codice Code	Ø Tubo Ø Tube	A	B	Nero/Black			Bianco/White		
				€	Pz x conf Pcs/box- bag	Lotto min Min order	€	Pz x conf Pcs/box- bag	Lotto min Min order
11.10.149.02	15	24	20	-	2000	2000	-	2000	10000
11.10.150.02	16	20	14	-	2500	2500	-	2500	10000
11.10.151.02	18	23	17	-	2500	5000	-	2500	10000
11.10.152.02	20	25	19	-	2000	2000	-	2000	6000
11.10.153.02	22	22	18	-	2500	2500	-	2500	5000
11.10.154.02	24	23	17	-	2000	2000	-	2000	6000
11.10.155.02	25	23	17	-	2000	2000	-	2000	6000
11.10.156.02	26	25	19	-	2000	2000	-	2000	6000
11.10.157.02	28	26	20	-	2000	4000	-	2000	4000
11.10.158.02	30	27	21	-	1500	1500	-	1500	6000

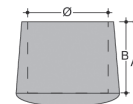

Puntali per piedi letto in PE / Insert for bed feet in PE

PPL

Codice Code	A	B	C	D	Nero/Black		
					€	Pz x conf Pcs/box- bag	Lotto min Min order
11.23.141.02	Ø50	Ø64	32	9,5	-	350	350

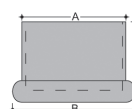

## ERI



### Puntali inclinati 20° in PVC / Round 20° inclined insert in PVC

Codice Code	Ø Tubo Ø Tube	A	B	C	Nero/Black			Bianco/White		
					€	Pz x conf Pcs/box- bag	Lotto min Min order	€	Pz x conf Pcs/box- bag	Lotto min Min order
11.10.185.01	25	38	27	20	-	1500	1500	-	1500	6000

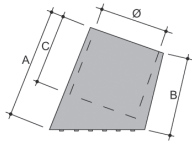

## ERL



### Punt. est.rett 15X30/ Outer square caps 15x30

Codice Code	A	B	C	Nero/Black		
				€	Pz x conf Pcs/box- bag	Lotto min Min order
11.10.250.02	30	15	23	-	3000	3000

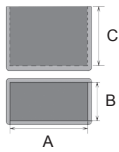

## 10 - PUNTALI OVALI E PIEDI SCALE/ OVAL INSERT AND LADDER FEET

## STY



### Puntale esterno in PP / Outer cap in PP

Codice Code	A	B	C	D	Nero/Black			Colorato/Coloured		
					€	Pz x conf Pcs/box- bag	Lotto min Min order	€	Pz x conf Pcs/box- bag	Lotto min Min order
11.10.190.02	20	35	23	20	-	400	2800	-	400	5000



## POB2



### Puntale esterno ovale con base inclinata in PVC Oval insert with inclined base in PVC

Codice Code	A	B	C	D	Nero/Black			Bianco/White		
					€	Pz x conf Pcs/box- bag	Lotto min Min order	€	Pz x conf Pcs/box- bag	Lotto min Min order
11.11.170.01	15	30	26	40	-	1000	1000	-	1000	5000

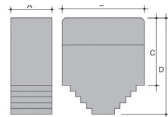

## PEO



### Puntale esterno ovale in PVC / Outer oval insert in PVC

Codice Code	A	B	C	Nero/Black			Bianco/White		
				€	Pz x conf Pcs/box- bag	Lotto min Min order	€	Pz x conf Pcs/box- bag	Lotto min Min order
11.11.174.01	15	30	23	-	3000	3000	-	3000	9000
11.11.175.01	18	36	27	-	1500	1500	-	1500	9000
11.11.176.01	20	40	28	-	1500	1500	-	1500	9000

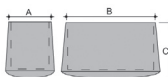

Puntale esterno ovale in PVC / Outer oval insert in PVC

Codice Code	A	B	C	Nero/Black			Bianco/White		
				€	Pz x conf Pcs/box- bag	Lotto min Min order	€	Pz x conf Pcs/box- bag	Lotto min Min order
11.11.120.01	30	15	23	-	3500	7000	-	3500	10500

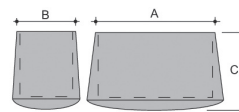

PEE



Piedi scala artiglio in PVC / Ladder insert in PVC

Codice Code	D	A	B	C	Nero/Black		
					€	Pz x conf Pcs/box- bag	Lotto min Min order
11.11.141.01	Ø30	69	53	78 x 42	-	200	200
11.11.142.01	Ø32	72	59	82 x 45	-	200	200
11.11.143.01	Ø35	71	56	86 x 46	-	150	150
11.11.144.01	Ø38	83	67	92 x 52	-	150	150
11.11.145.01	Ø40	78	62	91 x 52	-	100	100

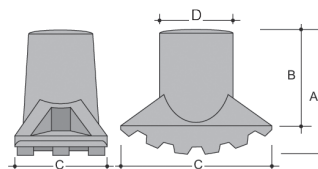

PSAR

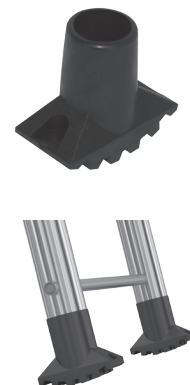

Piedi scala artiglio ovale in PVC / Ladder ovale feet in PVC

Codice Code	D	A	B	C	Nero/Black		
					€	Pz x conf Pcs/box- bag	Lotto min Min order
11.11.161.01	20x40	70	57	90x37	-	200	200
11.11.162.01	25x50	89	77	110x46	-	100	1000

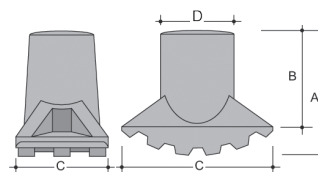

PSAO



Piedi scala a pera in PVC / Ladder insert in PVC

Codice Code	Ø Tubo Ø Tube	A	B	C	Nero/Black		
					€	Pz x conf Pcs/box- bag	Lotto min Min order
11.11.151.01	20	35	29	31	-	1000	1000
11.11.152.01	28	48	40	44	-	500	500
11.11.153.01	30	47	38	42	-	400	400
11.11.154.01	32	49	40	45	-	400	400
11.11.155.01	35	53	42	48	-	300	300
11.11.156.01	38	57	45	53	-	300	300
11.11.157.01	40	59	47	56	-	200	200
11.11.158.01	45	64	52	61	-	200	200

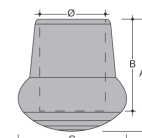

PSP

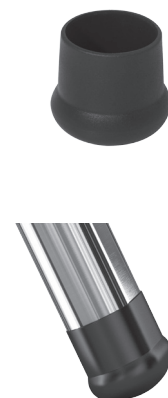

## PSPO



### Puntali scala a pera ovali in PVC / Ladder oval feet in PVC

Codice Code	Misura Size	A	B	C	Nero/Black		
					€	Pz x conf Pcs/box-bag	Lotto min Min order
11.11.165.01	20	40	34	52x32	-	600	600
11.11.166.01	25	50	43	65x40	-	300	300

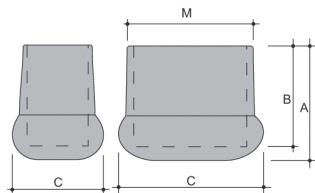

## 11 - PUNTALI PER SCAFFALATURE / INSERTS FOR SHELVING UNITS

## ASC



### Puntali per angolari in PE / Angle insert in PE

Codice Code	Misura Size	Spessore Thickness	A	B	Nero/Black		
					€	Pz x conf Pcs/box-bag	Lotto min Min order
11.12.104.02	27x27	1.5	11,5	9,5	-	3.500	3.500
11.12.100.02	30x30	3	12,5	10	-	3.000	3.000
11.12.101.02	35x35	3	12,5	10	-	3.000	3.000
11.12.102.02	40x40	3	13	10	-	2.250	2.250
11.12.103.02	32x32	3	12,5	10	-	3.000	3.000

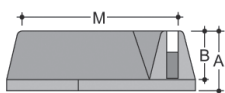

## ADS



### Puntali doppio angolare in PE / Double angle insert in PE

Codice Code	Misura Size	Spessore Thickness	A	B	Nero/Black		
					€	Pz x conf Pcs/box-bag	Lotto min Min order
11.12.105.02	70x35	2	12,5	10	-	1.000	5.000



Puntali per angolari a L in PE / Angle bases L type in PE

Codice Code	Misura Size	Spessore Thickness	A	B	Nero/Black			
					€	Pz x conf Pcs/box-bag	Lotto min Min order	
11.12.110.02	Destra/right	35x55	2	12.5	9.5	-	1.000	5000
11.12.112.02	Destra/right	20x40	2	13.0	10.0	-	5.000	5000
11.12.111.02	Sinistra/left	35x55	2	12.5	9.5	-	1.000	5000
11.12.113.02	Sinistra/left	20x40	2	13.0	10.0	-	5.000	5000

ASL

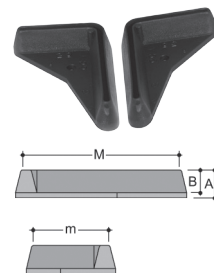

Puntali angolari a U in PVC / Angle insert U type in PVC

Codice Code	Misura Size	Spessore Thickness	A	B	Nero/Black		
					€	Pz x conf Pcs/box-bag	Lotto min Min order
11.12.115.01	30x30x35	2	25	18	-	500	1.000

AUS



Puntali angolari in PE / Angle insert in PE

Codice Code	Misura Size	A	B	Nero/Black		
				€	Pz x conf Pcs/box-bag	Lotto min Min order
11.12.121.02	20x20	20	15	-	2.000	2.000
11.12.122.02	25x25	24	19	-	2.000	2.000
11.12.123.02	30x30	24	19	-	1.000	1.000
11.12.124.02	35x35	24	19	-	1.000	1.000

EA



Adatti per essere infilati negli appoggi ad angolo  
Used to be put in angle supports

Puntali angolari base diritta in PE / Angle insert in PE

Codice Code	Misura Size	A	B	Nero/Black		
				€	Pz x conf Pcs/box-bag	Lotto min Min order
11.12.129.02	25x25	25	20	-	2.000	2.000

EAL



Puntale esterno per piatto in PVC / Angle insert in PVC

Codice Code	Misura Size	A	B	Nero/Black		
				€	Pz x conf Pcs/box-bag	Lotto min Min order
11.12.135.01	25x8	19	15	-	2.500	5.000
11.12.138.01	25x5	19	15	-	2.500	5.000
11.12.136.01	25x6	19	15	-	2.500	5.000
11.12.137.01	30x6	19	15	-	2.500	5.000

PEP

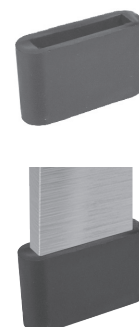

















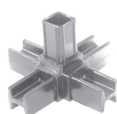

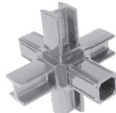
## 12 - INNESTI PER TUBI / TUBE CONNECTORS

### ITQ

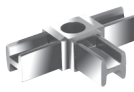
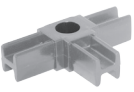
Tubo spessore mm 1,2  
Tube thickness mm 1,2

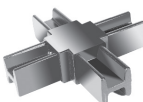
#### Innesti per tubo quadro 20x20 in ABS / Tube connector for tube 20x20 in ABS

Codice Code	Mod.	A	B	C	Nero/Black			Cromato /Chrome plated			Metallizzato/Brass plated		
					€	Pz x conf Pcs/box- bag	Lotto min Min order	€	Pz x conf Pcs/box- bag	Lotto min Min order	€	Pz x conf Pcs/box- bag	Lotto min Min order
21.12.201.00	3 vie / ways	25	25	17,6	-	50	50	-	50	50	-	50	50
													
21.12.202.00	4 vie / ways	25	25	17,6	-	50	50	-	50	50	-	50	50
													
21.12.203.00	5 vie / ways	25	25	17,6	-	50	50	-	50	50	-	50	50
													
21.12.204.00	6 vie / ways	25	25	17,6	-	50	50	2-	50	50	-	50	50
													
21.12.205.00	mod a "L" "L" type	25	25	17,6	-	50	100	-	50	100	-	50	100
													
21.12.206.00	mod a "T" "T" type	25	25	17,6	-	50	50	-	50	50	-	50	50
													
21.12.207.00	CROCE Cross	25	25	17,6	-	50	50	-	50	50	-	50	50
													

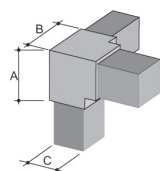

Innesti per tubo quadro 25x25 in ABS / Tube connector for tube 25x25 in ABS

ITQ

Tubo spessore mm 1,2  
Tube thickness mm 1,2

Codice Code	Mod.	A	B	C	Nero/Black			Cromato/Chrome plated			Metallizzato/Metal plated		
					€	Pz x conf Pcs/ box-bag	Lotto min Min order	€	Pz x conf Pcs/ box-bag	Lotto min Min order	€	Pz x conf Pcs/ box-bag	Lotto min Min order
21.12.211.00	3 vie / ways	30	30	22,6	-	25	50	-	25	50	-	25	50

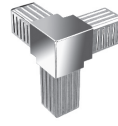

21.12.212.00	4 vie / ways	30	30	22,6	-	25	50	-	25	50	-	25	50
--------------	--------------	----	----	------	---	----	----	---	----	----	---	----	----

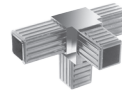

21.12.213.00	5 vie / ways	30	30	22,6	-	25	50	-	25	50	-	25	50
--------------	--------------	----	----	------	---	----	----	---	----	----	---	----	----



21.12.215.00	mod a "L" "L" type	30	30	22,6	-	25	100	-	25	100	-	25	100
--------------	--------------------	----	----	------	---	----	-----	---	----	-----	---	----	-----

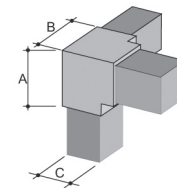
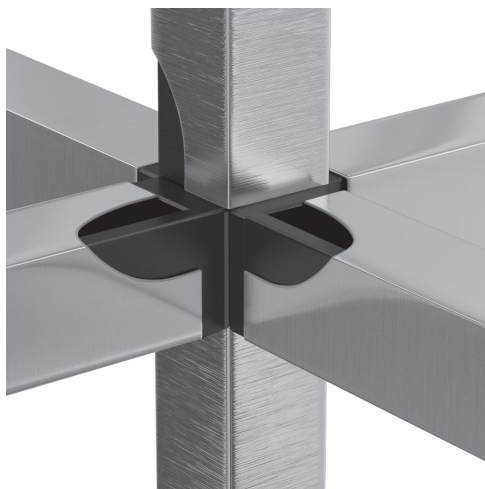
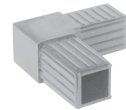
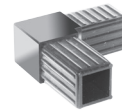

## 13- ARTICOLI VARI / MISCELLANEOUS

### RL

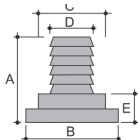

Reggi lamiera ® Gambo per foro Ø 5 in PA neutro  
Metal support leg hole ø 5 in neutral PA

Codice Code	A	B	C	D	E	Neutro/Neutral		
						€	Pz x conf Pcs/box-bag	Lotto min Min order
11.17.126.05	11,5	12	9	5	4	-	5000	5000

### CFS



Copriforo per serramenti in PVC / Tube cover for windows in PVC

Codice Code	A	B	C	D	Nero/Black			Grigio/Grey		
					€	Pz x conf Pcs/box-bag	Lotto min Min order	€	Pz x conf Pcs/box-bag	Lotto min Min order
11.91.101.01	16	11,5	2	2,5	-	5000	5000	-	5000	10000

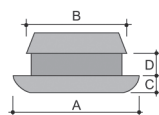

### PAT

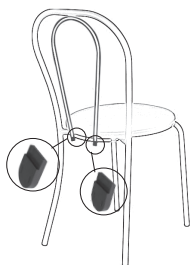

Protezione aletta thonet in PE / Protection thonet fin in PE

Codice Code	A	B	C	Nero/Black		
				€	Pz x conf Pcs/box-bag	Lotto min Min order
11.17.119.02	27,5	20	8	-	5000	5000

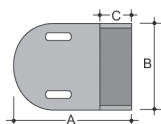

### MAC

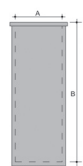

Manopole per carriole in PE / Handle for wheelbarrow in PE

Codice Code	A	B	Nero/Black			Colorato/Coloured		
			€	Pz x conf Pcs/box-bag	Lotto min Min order	€	Pz x conf Pcs/box-bag	Lotto min Min order
12.01.233.02	ø28	92	-	600	600	-	600	10000
12.01.238.02	ø30	92	-	600	600	-	600	10000
12.01.239.02	ø32	92	-	600	600	-	600	10000

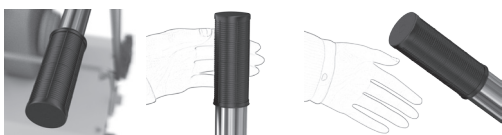

### MAL

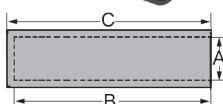

Manopola liscia in PVC / Smooth handle in PVC

Codice Code	A	B	C	Nero/Black		
				€	Pz x conf Pcs/box-bag	Lotto min Min order
22.01.310.00	ø 30	98	100	-	-	7500

Paraspigoli per mobili in PE / Corner cover for furniture in PE

Codice Code	A	B	C	Nero/Black		
				€	Pz x conf Pcs/box-bag	Lotto min Min order
11.17.105.02	60	60	26	-	1250	1250

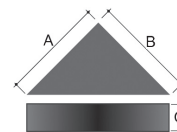

PRM



Paraspigoli per mobili in PE / Corner cover for furniture in PE

Codice Code	A	B	C	Nero/Black		
				€	Pz x conf Pcs/box-bag	Lotto min Min order
11.17.106.02	55	55	30	-	750	750
11.17.108.02	55	55	25	-	750	750
11.17.109.02	55	55	20	-	750	750

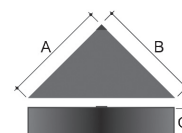

PRM



Paraspigolo sagomato per mobili in PE / Corner cover for furniture in PE

Codice Code	A	B	C	Nero/Black		
				€	Pz x conf Pcs/box-bag	Lotto min Min order
11.17.140.02	114	114	19	-	500	500
11.17.141.02	114	114	25	-	400	400
11.17.142.02	114	114	30	-	300	300

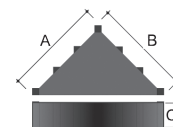

PRMS

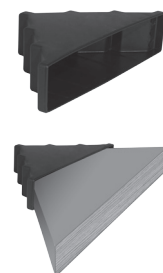

Paraspigolo triangolare / Triangularcorner cover

Codice Code	A	B	C	D	Nero/Black		
					€	Pz x conf Pcs/box-bag	Lotto min Min order
11.17.150.02	70,7	70,7	100	50	-	-	-

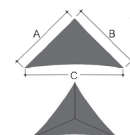

PRMT



Paraspigolo a sezione per mobili in PE / Sectional corner cover for furniture in PE

Codice Code	A	B	Nero/Black		
			€	Pz x conf Pcs/box-bag	Lotto min Min order
11.17.145.02	100	19	-	1000	3000
11.17.146.02	100	25	-	800	4000
11.17.147.02	100	30	-	700	700

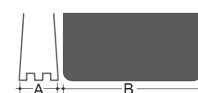

PMS

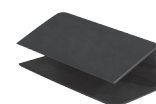

# 14 - ACCESSORI PER SEDIE / FITTINGS FOR CHAIRS

## SP

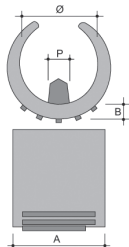

### Sottopiede a pinza in PE / Saddle feet in PE

Codice Code	Misura Size	Ø Piolo Ø Peg	A	B	Nero/Black			Bianco/White		
					€	Pz x conf Pcs/box-bag	Lotto min Min order	€	Pz x conf Pcs/box-bag	Lotto min Min order
11.20.181.02	14 - 16	5,5	18	3,5	-	4000	4000	-	4000	4000
11.20.182.02	16 - 18	5,5	19	3,5	-	4000	4000	-	4000	8000
11.20.183.02	18 - 20	5,5	20	3,5	-	4000	4000	-	4000	4000
11.30.011.02	18 - 20	4,0	18	3,5	-	4000	4000	-	4000	12000
11.20.185.02	20 - 22	5,5	22	4,0	-	3000	3000	-	3000	3000
11.20.184.02	24 - 26	5,5	25	5,0	-	3000	3000	-	3000	3000
11.20.243.02	24 - 26	7,5	25	5,0	-	3000	3000	-	3000	3000
11.20.186.02	28 - 30	7,5	30	5,5	-	1750	1750	-	1750	1750
11.20.050.02	22 - 24	4,0	22	4,0	-	4000	4000	-	4000	8000

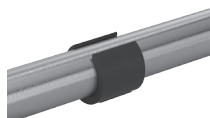

## SPL

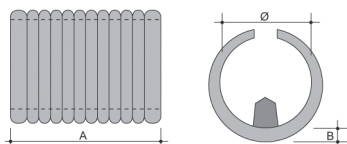

### Sottopiede a pinza lungo in PE / Saddle feet long type in PE

Codice Code	Misura Size	Ø Piolo Ø Peg	A	B	Nero/Black			Bianco/White		
					€	Pz x conf Pcs/box-bag	Lotto min Min order	€	Pz x conf Pcs/box-bag	Lotto min Min order
11.20.176.02	18 - 20	6	46	4,5	-	1500	1500	-	1500	10500
11.20.178.02	24 - 26	8	46	5,0	-	1000	1000	-	1000	10000
11.20.179.02	28 - 30	8	46	5,5	-	1000	1000	-	1000	10000

## SPQ

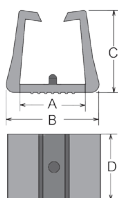

### Sottopiede pinza quadra 25X25 / Square feet pillar 25x25

Codice Code	A	B	C	D	Nero/Black		
					€	Pz x conf Pcs/box-bag	Lotto min Min order
11.30.009.02	25	34	31	25	-	-	-

Distanziatore a pinza in PE / Saddle feet in PE

Codice Code	Misura Size	A	B	Nero/Black			Bianco/White		
				€	Pz x conf Pcs/box-bag	Lotto min Min order	€	Pz x conf Pcs/box-bag	Lotto min Min order
11.20.206.02	18-20	18	3,0	-	4000	4000	-	4000	12000
11.20.207.02	24-26	18	3,5	-	2000	2000	-	2000	10000

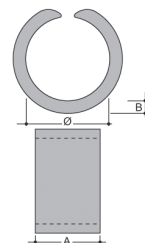

Anello sottopiede in PVC / Feet ring in PVC

Codice Code	Ø Interno Ø Inner	A	B	Nero/Black			Bianco/White		
				€	Pz x conf Pcs/box-bag	Lotto min Min order	€	Pz x conf Pcs/box-bag	Lotto min Min order
11.20.195.01	14	19	13	-	5000	5000	-	5000	10000
11.20.196.01	16	22	15	-	5000	5000	-	5000	10000
11.20.197.01	18	24	16	-	5000	5000	-	5000	10000
11.20.198.01	20	26	17	-	5000	5000	-	5000	10000

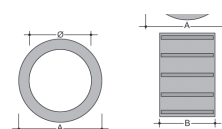

Pinza a 2 pioli in PE / Pliers two posts in PE

Codice Code	A	B	C	D	E	Nero/Black			Neutro/Neutral		
						€	Pz x conf Pcs/box-bag	Lotto min Min order	€	Pz x conf Pcs/box-bag	Lotto min Min order
11.20.200.02	33	13,5	18	4,5	2,5	-	10.000	10.000	-	10.000	10.000

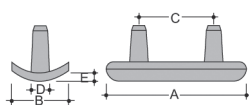

Pinza a 2 pioli in PE / Pliers two posts in PE

Codice Code	A	B	C	D	E	Nero/Black		
						€	Pz x conf Pcs/box-bag	Lotto min Min order
11.30.010.02	33	13,5	18	4,5	5	-	10.000	10.000

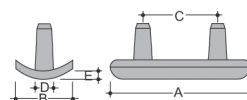

## PAR

### Piedino a 90° antiribaltamento in PP / Feet 90° anti-upsetting in PP

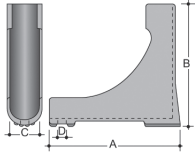

FORO PER FISSAGGIO AL PAVIMENTO  
FLOOR FIXING HOLE

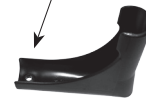

Codice Code	A	B	C	D	Nero/Black		
					€	Pz x conf Pcs/box-bag	Lotto min Min order
11.20.191.02	106	100	Ø25	Ø5,5	-	300	300

## PARP

### Piedino antiribaltamento in PP / Anti-upsetting feet in PP

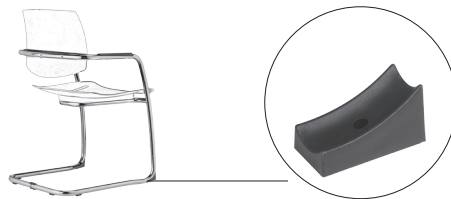
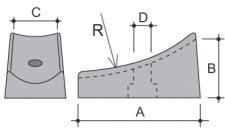

Codice Code	A	B	C	D	R	Nero/Black		
						€	Pz x conf Pcs/box-bag	Lotto min Min order
11.20.192.02	43	19	Ø25	Ø5	60	-	2.000	2.000

## PART

### Piedino antiribaltamento per telaio slitta D25/ Anti-upsetting feet for cantilever D25

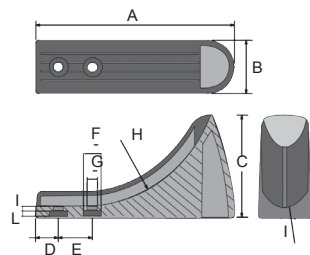

Codice Code	A	B	C	D	E	F	G	H	I	L	M	Nero/Black		
												€	Pz x conf Pcs/box-bag	Lotto min Min order
11.70.119.02	105	28	55	12	18	Ø10	Ø5.5	63°	2.5	4	13°	-	-	-



## PATS

### Piedino anteriore per telaio slitta D25/ Front feet for cantilever D25

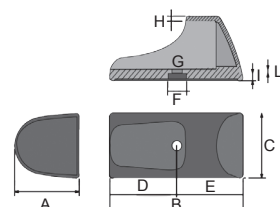
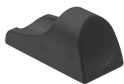

Codice Code	A	B	C	D	E	F	G	H	I	L	Nero/Black		
											€	Pz x conf Pcs/box-bag	Lotto min Min order
11.70.118.02	34	70	34	35	35	Ø10	Ø5.5	2.5	4	2	-	-	-



Copritesta semiovale porta ruote / *Semioval tube cover for castors*

Codice Code	A	B	C	D	Nero/Black		
					€	Pz x conf Pcs/box-bag	Lotto min Min order
11.20.158.02	40	20	Ø10	P26	-	1.500	1.500

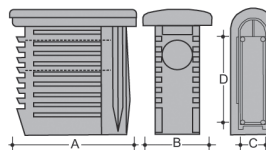

CSPR



Coprisaldatura base 5 razze / *Welding cover for 5 leg bases*

Codice Code	A	B	C	D	E	F	Nero/Black		
							€	Pz x conf Pcs/box-bag	Lotto min Min order
11.20.270.02	Ø40	20	Ø80	87	Ø40	6	-	180	180
11.20.271.02	Ø40	20	Ø80	87	Ø50	6	-	180	180



CSB

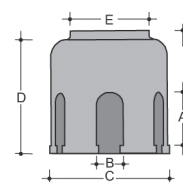

Protezione scocche legno in PVC / *Protection for wooden chairs in PVC*

Codice Code	A	B	C	D	E	Neutro/Neutral		
						€	Pz x conf Pcs/box-bag	Lotto min Min order
11.22.164.01	38	29	22	11	16	-	2500	2500

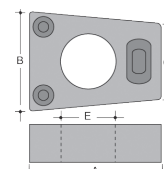

PSL

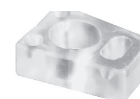

Protezione per telaio ovale / *Protection for oval tube frame*

Codice Code	A	B	C	Nero/Black		
				€	Pz x conf Pcs/box-bag	Lotto min Min order
11.22.162.02	15	30	30	-	2500	2500

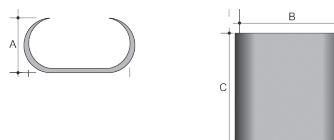

PTF

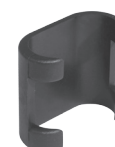

Protezione per telaio tondo / *Protection for round tube frame*

Codice Code	A	B	Nero/Black		
			€	Pz x conf Pcs/box-bag	Lotto min Min order
11.22.155.02	22	69	-	2500	2500



PTT

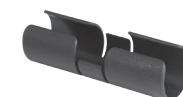

## AGO

### Agganci ad omega in PP / Hooks in PP

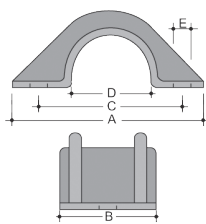

Codice Code	Per Tubo For tube	A	B	C	D	E	Nero/Black		
							€	Pz x conf Pcs/box-bag	Lotto min Min order
11.22.165.02	Ø 25	64	27	44	25	Ø5,8	-	500	500
11.22.166.02	Ø 20	52	26	35	20	Ø6	-	1000	1000
11.22.167.02	Ø 16	52	26	35	16	Ø6	-	1000	2000



## BS

### Bracciolo sagomato in PS tubo Ø 25 / Curved armrest IN ps - tube Ø 25

Codice Code	A	B	C	D	E	Nero/Black		
						€	Pz x conf Pcs/box-bag	Lotto min Min order
11.20.170.03	305	17	35	45	172	-	120	500

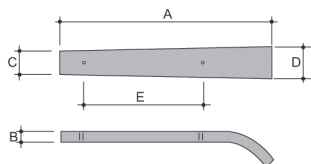
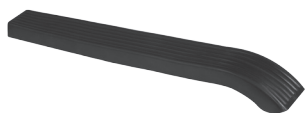

## BSB

### Bracciolo sagomato in PS con buccole filettate M6 in ottone per tubo Ø 25 Curved armrest in PS with threaded nuts for tube Ø 25

Codice Code	A	B	C	D	E	Nero/Black		
						€	Pz x conf Pcs/box-bag	Lotto min Min order
11.20.171.30	305	17	35	45	172	-	120	500

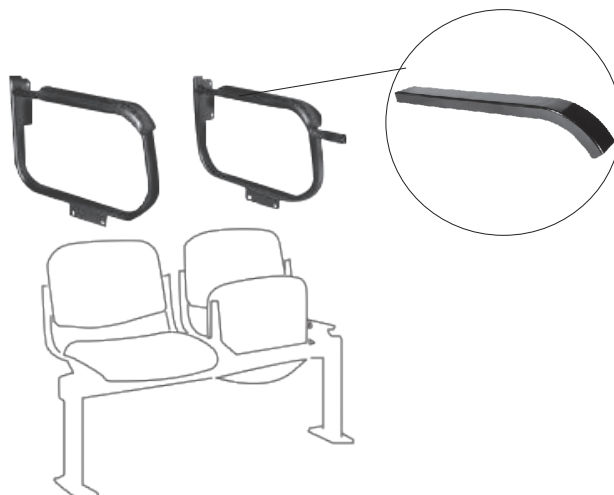
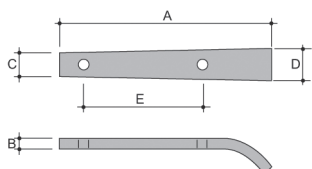

# 15 - PUNTALI A MEZZA SFERA A SCATTO / SNAP INSERTS

## Base plastica in PE / Round plastic snap insert in PE

Codice Code	A	B	B	Nero/Black		
				€	Pz x conf Pcs/box-bag	Lotto min Min order
11.21.110.02	19	6,0	13	-	5000	5000
11.21.111.02	26	6,5	13	-	3000	3000

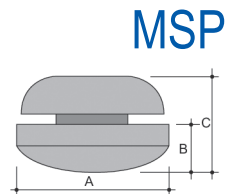

## Borchia liscia per saldatura autogena in FE / Smooth iron stud for welding

Codice Code	A	B	B	Prezzo/Price		
				€	Pz x conf Pcs/box-bag	Lotto min Min order
11.21.101.67	20,0	9,0	6,7	-	5000	5000
11.21.102.67	28,5	9,5	9,0	-	3000	3000

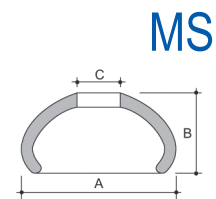

## Borchia con sporgenza per saldatura elettrica in FE / Smooth iron stud for welding

Codice Code	A	B	C	Prezzo/Price		
				€	Pz x conf Pcs/box-bag	Lotto min Min order
11.21.103.67	20,0	9,5	6,7	-	2500	5000
11.21.104.67	28,5	10,0	8,7	-	1500	1500

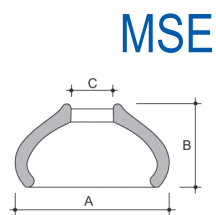

**MS +MSP**

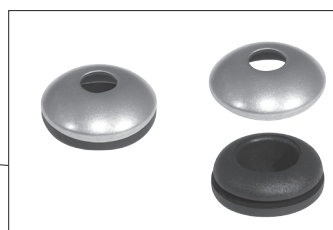

oppure  
or

**MSE+MSP**



## Base plastica piana in PE / Plastic insert in PE

Codice Code	A	B	C	Nero/Black		
				€	Pz x conf Pcs/box-bag	Lotto min Min order
11.21.112.02	18,5	5	10	-	2500	5000

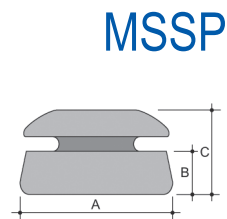

## Borchia testa sagomata in FE / Flat stud in FE

Codice Code	A	B	C	Prezzo/Price		
				€	Pz x conf Pcs/box-bag	Lotto min Min order
11.21.105.67	20,5	7,5	7	-	2500	5000

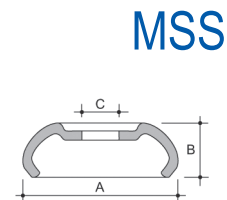

**MSS+MSSP**



# 16 - DISTANZIATORI E PARACOLPI / SPACERS AND BUFFERS

## TD

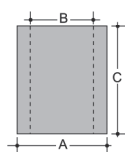

### Tubetto distanziatore in PE / Spacers in PE

Codice Code	A	B	C	Nero/Black			Bianco/White		
				€	Pz x conf Pcs/box- bag	Lotto min Min order	€	Pz x conf Pcs/box- bag	Lotto min Min order
11.22.100.02	8	4	5	-	5000	10000	-	5000	10000
11.22.101.02	8	5	3,7	-	5000	5000	-	5000	10000
11.22.102.02	10	4	20	-	5000	5000	-	5000	10000
11.22.103.02	10	6	4	-	5000	5000	-	5000	10000
11.22.104.02	10	6	6	-	5000	5000	-	5000	10000
11.22.105.02	10	6	9	-	5000	5000	-	5000	10000
11.22.106.02	10	6	10	-	5000	5000	-	5000	10000
11.22.107.02	10	6	12	-	5000	5000	-	5000	10000
11.22.108.02	10	6	14	-	5000	5000	-	5000	10000
11.22.109.02	10	6	15	-	5000	5000	-	5000	10000
11.22.110.02	10	6	17	-	5000	5000	-	5000	10000
11.22.111.02	10	6	19	-	5000	5000	-	5000	10000
11.22.112.02	11	4	10	-	5000	5000	-	5000	10000
11.22.113.02	11,5	7,5	5	-	5000	5000	-	5000	10000
11.22.121.02	12	8	5	-	5000	10000	-	5000	10000
11.22.114.02	12	8,5	6	-	5000	5000	-	5000	10000
11.22.115.02	13	6,3	3,5	-	5000	5000	-	5000	10000
11.22.116.02	14	5	3	-	5000	5000	-	5000	10000
11.22.119.02	14	5	9	-	5000	5000	-	5000	10000
11.22.117.02	14	6,5	7	-	5000	5000	-	5000	10000
11.22.118.02	17	6	10	-	5000	5000	-	5000	10000
11.22.123.02	24	10	15	-	2500	2500	-	2500	10000

## DB

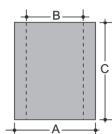

### Tubetto distanziatore in PP / Spacers in PP

Codice Code	A	B	C	Nero/Black		
				€	Pz x conf Pcs/box- bag	Lotto min Min order
11.20.349.02	17,5	8	12	-	3000	3000

## DR

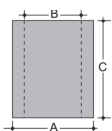
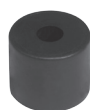

### Tubetto distanziatore in PP / Spacers in PP

Codice Code	A	B	C	Nero/Black		
				€	Pz x conf Pcs/box- bag	Lotto min Min order
11.20.492.02	22,5	7,3	18,8	-	1000	5000

## TC

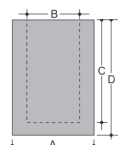
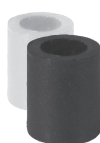

### Tubetto paracolpi ciechi n PVC / Buffers in PVC

Codice Code	A	B	C	D	Nero/Black			Bianco/White		
					€	Pz x conf Pcs/box- bag	Lotto min Min order	€	Pz x conf Pcs/box- bag	Lotto min Min order
11.22.190.01	17	12	21	24	-	5000	5000	-	5000	10000
11.22.191.01	14	6	16,5	18	-	5000	5000	-	5000	10000

Tubetti distanziatori con incavo in PE / Spacers in PE with cavity

Codice Code	A	B	C	D	Nero/Black			Bianco/White		
					€	Pz x conf Pcs/box- bag	Lotto min Min order	€	Pz x conf Pcs/box- bag	Lotto min Min order
11.22.125.02	13	5,5	5	9,5	-	5000	10000	-	5000	10000
11.22.126.02	13	5,5	7	11,5	-	5000	10000	-	5000	10000
11.22.127.02	13	5,5	14	18	-	5000	5000	-	5000	10000
11.22.128.02	17	6	5	9	-	5000	5000	-	5000	10000
11.22.129.02	17	6	7	11,5	-	5000	5000	-	5000	10000
11.22.130.02	17	6	10	14,5	-	5000	5000	-	5000	10000
11.22.131.02	17	6	14	18,5	-	5000	5000	-	5000	10000
11.22.132.02	17	6	16	21	-	5000	5000	-	5000	10000

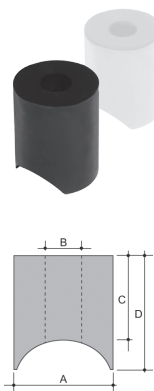

TDI

Distanziatore conico nero / Spacers with cavity

Codice Code	A	B	C	Nero/Black		
				€	Pz x conf Pcs/box- bag	Lotto min Min order
11.22.140.02	14	5	9	-	10000	10000

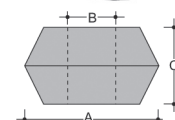

DZC

Distanziatore bombato zigrinato in PE / Round spacers in PE

Codice Code	A	B	C	Bianco/White		
				€	Pz x conf Pcs/box- bag	Lotto min Min order
11.22.141.02	20	5	8	-	10000	10000

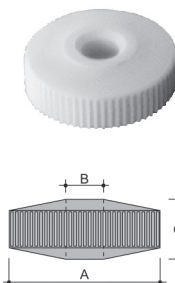

DZB

Distanziatore liscio in PE / Round spacers in PE

Codice Code	A	B	C	Nero/Black			Bianco/White		
				€	Pz x conf Pcs/box- bag	Lotto min Min order	€	Pz x conf Pcs/box- bag	Lotto min Min order
11.22.142.02	20	6,5	7	-	5000	5000	-	5000	5000

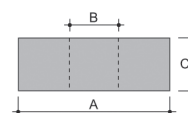

DZL

## PT

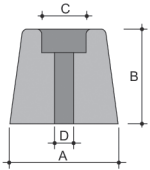

### Paracolpi troncoconici in PVC / Cone buffer in PVC

Codice Code	A	B	C	D	Nero/Black			Bianco/White		
					€	Pz x conf Pcs/box-bag	Lotto min Min order	€	Pz x conf Pcs/box-bag	Lotto min Min order
11.22.171.01	29	12	13,5	5	-	3000	3000	-	3000	3000
11.22.172.01	25	10	9	3	-	5000	5000	-	5000	5000
11.22.230.01	22	13,5	10	5	-	3000	3000	-	3000	9000
11.22.173.01	21	11	9	4	-	5000	5000	-	5000	10000
11.22.174.01	19	10	9	4	-	5000	5000	-	5000	5000
11.22.175.01	19	13	8	4	-	5000	5000	-	5000	5000
11.22.176.01	18,5	18	8	4	-	5000	5000	-	5000	5000
11.22.177.01	18	8	7	3	-	5000	5000	-	5000	5000
11.22.178.01	13	6	6	3	-	5000	5000	-	5000	5000

## RSS

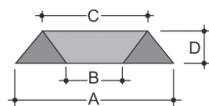

### Rondella sottovite svasata in PA / Countersunk washer in PA

Codice Code	A	B	C	D	Nero/Black			Bianco/White		
					€	Pz x conf Pcs/box-bag	Lotto min Min order	€	Pz x conf Pcs/box-bag	Lotto min Min order
11.22.147.05	Ø15	Ø5,4	Ø10	3	-	10000	10000	-	10000	20000

## PIT

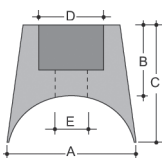

### Paracolpi con incavo in PVC / Buffer with cavity in PVC

Codice Code	A	B	C	D	E	Nero/Black			Bianco/White		
						€	Pz x conf Pcs/box-bag	Lotto min Min order	€	Pz x conf Pcs/box-bag	Lotto min Min order
11.22.186.01	20	9	14	9	5	-	3000	3000	-	3000	12000
11.22.187.01	23	12	18	10	5	-	3000	3000	-	3000	12000

## PIC

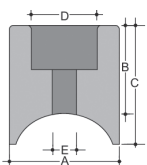

### Paracolpi con incavo cilindrici in PVC / Cylindrical buffer with cavity in PVC

Codice Code	A	B	C	D	E	Nero/Black			Bianco/White		
						€	Pz x conf Pcs/box-bag	Lotto min Min order	€	Pz x conf Pcs/box-bag	Lotto min Min order
11.22.221.01	25	20	28	15	6	-	1000	1000	-	1000	10000

### Ferma battute porte in PVC / Door buffer in PVC

FBP

Codice Code	A	B	C	D	Nero/Black			Bianco/White		
					€	Pz x conf Pcs/box- bag	Lotto min Min order	€	Pz x conf Pcs/box- bag	Lotto min Min order
11.22.223.01	20	23	9	4	-	2000	2000	-	2000	10000
11.22.224.01	25	24	11	5	-	2000	2000	-	2000	10000
11.22.225.01	30	25	13	6	-	1250	1250	-	1250	10000

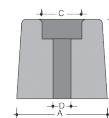
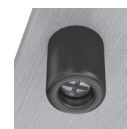

### Tappetino forato svuotato in PE / PE spacer

TFS

Codice Code	A	B	C	Nero/Black		
				€	Pz x conf Pcs/box- bag	Lotto min Min order
11.22.180.02	25	19,5	10	-	3000	3000

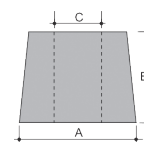

### Rondelle paracolpi in PVC / Washers in PVC

RP

Codice Code	A	B	C	D	Nero/Black			Bianco/White		
					€	Pz x conf Pcs/box- bag	Lotto min Min order	€	Pz x conf Pcs/box- bag	Lotto min Min order
11.22.211.01	25	6	10	2	-	5000	5000	-	5000	10000
11.22.212.01	22	6	10	3	-	5000	5000	-	5000	10000
11.22.213.01	18	6	9,5	3	-	5000	5000	-	5000	10000
11.22.214.01	15	5	8,5	5	-	5000	5000	-	5000	10000
11.22.215.01	10	5	5	3	-	5000	5000	-	5000	10000

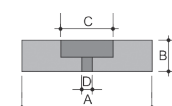

### Paracolpi quadrati neri in PVC / Square inserts in PVC

PQ

Codice Code	A	B	C	Normali/Normal			Morbidi/Soft		
				€	Pz x conf Pcs/box- bag	Lotto min Min order	€	Pz x conf Pcs/box- bag	Lotto min Min order
11.22.185.01	22X22	8	11	-	5000	15000	/	/	/
11.22.185.S1	22X22	8	11	/	/	/	-	5000	15000

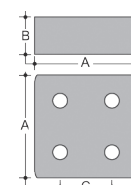
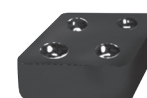

# 17 - PARACOLPI A FUNGO / MUSHROOM-SHAPED BUFFERS

## PF1

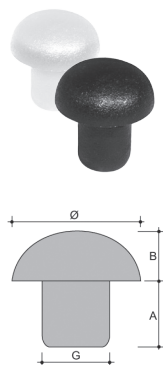

### Testa rotonda / Round head buffer

Codice Code	Ø testa Ø head	Ø gambo Ø stem	A	B	Nero/Black			Bianco/White		
					€	Pz x conf Pcs/box- bag	Lotto min Min order	€	Pz x conf Pcs/box- bag	Lotto min Min order
<i>Duri Hard</i>										
11.22.235.02	9	5	6	3	-	5000	5000	-	5000	15000
11.22.236.02	14	9	6	4,5	-	5000	5000	-	5000	15000
11.22.237.02	14	6	15	6,5	-	5000	5000	-	5000	15000
11.22.238.02	20	10	10	8	-	5000	5000	-	5000	10000
<i>Elastici Soft</i>										
11.22.235.01	9	5	6	3	-	5000	5000	-	5000	15000
11.22.236.01	14	9	6	4,5	-	5000	5000	-	5000	15000
11.22.237.01	14	6	15	6,5	-	5000	5000	-	5000	15000
11.22.238.01	20	10	10	8	-	5000	5000	-	5000	10000

## PF2

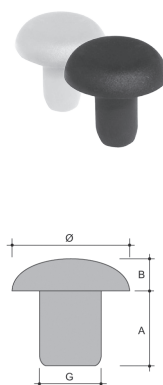

### Testa bombata / Round head buffer

Codice Code	Ø testa Ø head	Ø gambo Ø stem	A	B	Nero/Black			Bianco/White		
					€	Pz x conf Pcs/box- bag	Lotto min Min order	€	Pz x conf Pcs/box- bag	Lotto min Min order
<i>Duri Hard</i>										
11.22.245.02	9,5	5	6	3	-	5000	5000	-	5000	15000
11.22.246.02	12	6	7,5	3	-	5000	5000	-	5000	15000
11.22.247.02	14	6	15	4	-	5000	5000	-	5000	15000
11.22.248.02	18	8	15	5	-	5000	5000	-	5000	10000
11.22.249.02	20	8	15	5	-	5000	5000	-	5000	10000
11.22.250.02	24	11	13	5	-	5000	5000	-	5000	10000
<i>Elastici Soft</i>										
11.22.245.01	9,5	5	6	3	-	5000	5000	-	5000	15000
11.22.246.01	12	6	7,5	3	-	5000	5000	-	5000	15000
11.22.247.01	14	6	15	4	-	5000	5000	-	5000	15000
11.22.248.01	18	8	15	5	-	5000	5000	-	5000	10000
11.22.249.01	20	8	15	5	-	5000	5000	-	5000	10000
11.22.250.01	24	11	13	5	-	5000	5000	-	5000	10000

## PF3



### Testa piatta / Flat head buffer

Codice Code	Ø testa Ø head	Ø gambo Ø stem	A	B	Nero/Black			Bianco/White		
					€	Pz x conf Pcs/box- bag	Lotto min Min order	€	Pz x conf Pcs/box- bag	Lotto min Min order
<i>Duri Hard</i>										
11.22.255.02	12	6	9	2,5	-	5000	5000	-	5000	15000
11.22.256.02	12	6	9	3,8	-	5000	5000	-	5000	15000
11.22.257.02	7	3,5	5	1,5	-	5000	5000	-	5000	15000
<i>Elastici Soft</i>										
11.22.255.01	12	6	9	2,5	-	5000	5000	-	5000	30000
11.22.256.01	12	6	9	3,8	-	5000	5000	-	5000	15000
11.22.257.01	7	3,5	5	1,5	-	5000	5000	-	5000	30000

Testa piatta trasparente in PVC / Transparent flat buffer in PVC

Codice Code	Ø testa Ø head	Ø gambo Ø stem	A	B	Trasparenti/ Transparent		
					€	Pz x conf Pcs/box-bag	Lotto min Min order
11.22.256.01U	12	6	9	3,8	-	5000	5000

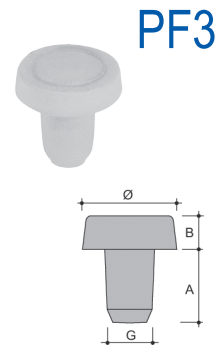

Testa rettangolare / Rectangular head buffer

Codice Code	testa head	Ø gambo Ø stem	A	B	Nero/Black			Bianco/White		
					€	Pz x conf Pcs/box-bag	Lotto min Min order	€	Pz x conf Pcs/box-bag	Lotto min Min order
<i>Duri Hard</i>										
11.22.270.02	15x10	6	9	4,5	-	5000	5000	-	5000	10000
11.22.271.02	15x10	6	9	10	-	5000	5000	-	5000	10000
<i>Elastici Soft</i>										
11.22.270.01	15x10	6	9	4,5	-	5000	5000	-	5000	10000
11.22.271.01	15x10	6	9	10	-	5000	5000	-	5000	10000

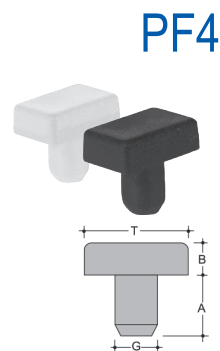

Testa bassa / Low head buffer

Codice Code	Ø testa Ø head	Ø gambo Ø stem	A	B	Nero/Black			Bianco/White		
					€	Pz x conf Pcs/box-bag	Lotto min Min order	€	Pz x conf Pcs/box-bag	Lotto min Min order
<i>Duri Hard</i>										
11.22.263.02	12,5	8	9	2	-	5000	5000	-	5000	10000
<i>Elastici Soft</i>										
11.22.263.01	12,5	8	9	2	-	5000	5000	-	5000	10000

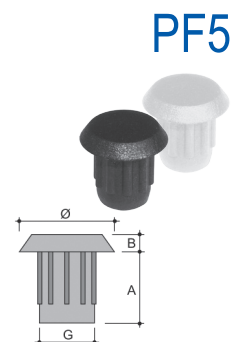

Paracolpi rotondi in PVC / Round buffers in PVC

Codice Code	Ø testa Ø head	Ø gambo Ø stem	A	B	Nero/Black			Bianco/White		
					€	Pz x conf Pcs/box-bag	Lotto min Min order	€	Pz x conf Pcs/box-bag	Lotto min Min order
<i>Elastici Soft</i>										
13.01.260.01	11	4,2	10	7	-	5000	5000	-	5000	20000

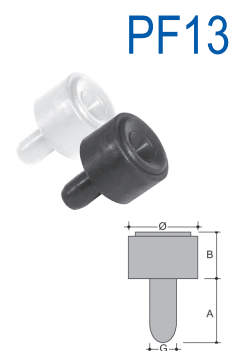

Paracolpi a tronco di cono in PE / Conical buffers in PE

Codice Code	Ø testa Ø head	Ø gambo Ø stem	A	B	Nero/Black			Bianco/White		
					€	Pz x conf Pcs/box-bag	Lotto min Min order	€	Pz x conf Pcs/box-bag	Lotto min Min order
<i>Duri Hard</i>										
11.22.314.02	12-16	6	12	11	-	5000	5000	-	5000	10000

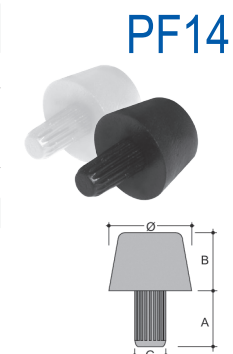

## PF3B

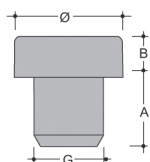

### Testa piatta trasparente in PVC / Transparent flat buffer in PVC

Codice Code	Ø testa Ø head	G	A	B	Trasparenti /Tranparent		
					€	Pz x conf Pcs/box-bag	Lotto min Min order
11.22.260.01	15	11	11	5,2	-	5000	20000

### Testa piatta in PE nero/ Black flat buffer in PE

Codice Code	Ø testa Ø head	G	A	0B	Nero/Black		
					€	Pz x conf Pcs/box-bag	Lotto min Min order
11.22.260.02	15	11	11	5,2	-	5000	5000

## PF15

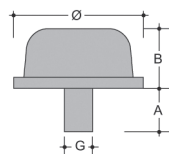

### Paracolpi con gambo in PE bianchi / White insert with bolt in PE

Codice Code	Ø testa Ø head	G	A	B	Bianco/White		
					€	Pz x conf Pcs/box-bag	Lotto min Min order
11.22.318.02	17	5	8,5	6,5	-	5000	5000
11.22.319.02	23,5	5	8,5	10	-	5000	5000

## PF16

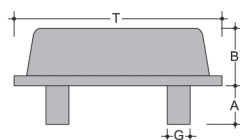

### Paracolpi con 2 gambi in PE bianchi / White inserts with 2 bolts in PE

Codice Code	T	G	A	B	Bianco/White		
					€	Pz x conf Pcs/box-bag	Lotto min Min order
11.22.339.02	43x15,5	5	8	12	-	4000	4000

## P4P

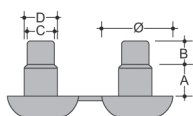

### Paracolpi 4 pezzi per stendibiancheria in PE / Inserts in 4 pcs

Codice Code	Ø testa Ø head	A	B	C	D	Nero/Black		
						€	Pz x conf Pcs/box-bag	Lotto min Min order
11.22.160.02	13	7	4	5	6	-	5500	5500

## 18 - PARACOLPI A SCATTO / SNAP BUFFERS

### Paracolpi testa bombata in PVC / Buffers with round head in PVC

Codice Code	Ø testa Ø head	Ø gambo Ø stem	A	B	Nero/Black			Bianco/White		
					€	Pz x conf Pcs/box-bag	Lotto min Min order	€	Pz x conf Pcs/box-bag	Lotto min Min order
<i>Elastici elastic</i>										
11.22.290.01	12	5	4,5	4	-	5000	5000	-	5000	10000

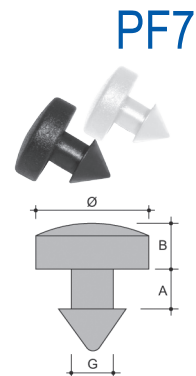

### Paracolpi testa rotonda in PVC / Round head buffer in PVC

Codice Code	Ø testa Ø head	A	B	C	Nero/Black			Bianco/White		
					€	Pz x conf Pcs/box-bag	Lotto min Min order	€	Pz x conf Pcs/box-bag	Lotto min Min order
<i>Elastici elastic</i>										
11.22.295.01	8	1,5	1	4	-	5000	5000	-	5000	10000

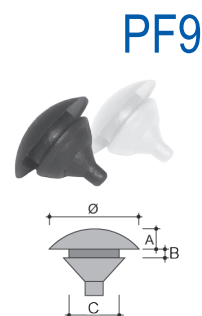

### Paracolpi testa bombata in PVC / Round head buffer in PVC

Codice Code	Ø testa Ø head	Ø gambo Ø stem	A	B	Nero/Black			Bianco/White		
					€	Pz x conf Pcs/box-bag	Lotto min Min order	€	Pz x conf Pcs/box-bag	Lotto min Min order
<i>Elastici elastic</i>										
11.22.299.01	12	6	1	2	-	5000	5000	-	5000	10000
11.22.300.01	12	6	1	4,5	-	5000	5000	-	5000	10000

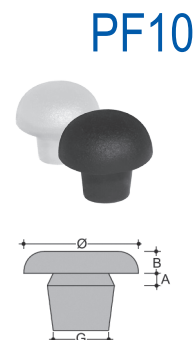

### Paracolpi con piolini in PVC / Buffer with posts in PVC

Codice Code	Ø testa Ø head	Ø gambo Ø stem	A	B	Nero/Black			Bianco/White		
					€	Pz x conf Pcs/box-bag	Lotto min Min order	€	Pz x conf Pcs/box-bag	Lotto min Min order
<i>Elastici elastic</i>										
11.22.310.01	12	7	1	4	-	5000	5000	-	5000	10000
11.22.311.01	12	7	1	6	-	5000	5000	-	5000	10000



## 19 - PARACOLPI CON CHiodO / BUFFERS WITH NAIL

### PF6

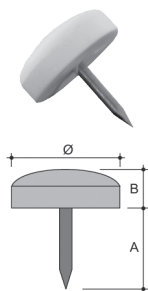

Paracolpi con chiodo testa rotonda in PE bianchi / Round head buffer with nail in PE

Codice Code	Ø testa Ø head	A	B	Bianco/White		
				€	Pz x conf Pcs/box-bag	Lotto min Min order
<i>Duri hard</i>						
21.22.305.00	8,5	10	3,5	-	5000	5000
11.22.278.25	16	12	5	-	5000	5000

### PF8

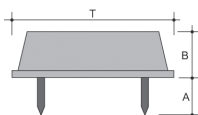

Paracolpi con 2 chiodi in PE bianchi / Buffer with double nail in PE

Codice Code	Ø testa Ø head	A	B	Bianco/White		
				€	Pz x conf Pcs/box-bag	Lotto min Min order
<i>Duri hard</i>						
11.22.285.25	46X16	10	14	-	2000	8000

### PC

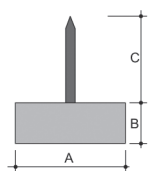

Paracolpi con chiodo in PVC / Buffer with nail in PVC

Codice Code	A	B	C	Nero/Black			Bianco/White		
				€	Pz x conf Pcs/box-bag	Lotto min Min order	€	Pz x conf Pcs/box-bag	Lotto min Min order
11.22.195.57	25	9	19	-	1000	1000	-	1000	3000
11.22.196.57	20	6	15	-	1000	2000	-	1000	2000
11.22.197.57	15	12	15	-	1000	1000	-	1000	5000
11.22.198.57	15	7	15	-	1000	1000	-	1000	5000

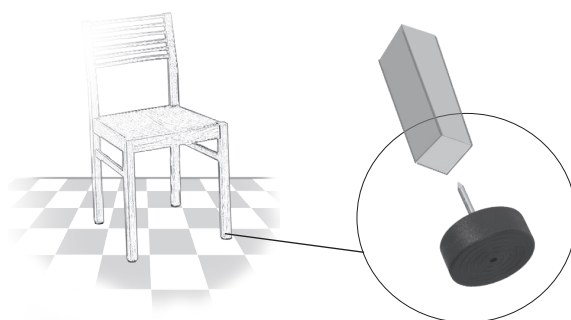

Paracolpi con chiodo e pattino in feltro / Buffer with nail and base in felt

PBF

Codice Code	A	B	C	D	Marrone/ Brown		
					€	Pz x conf Pcs/box-bag	Lotto min Min order
21.22.206.00	Ø 20	5	5	15	-	1000	1000
21.22.207.00	Ø 25	5	5	15	-	500	1000
21.22.200.00	Ø 30	5	5	15	-	1000	1000

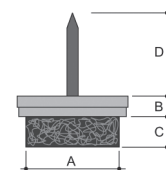
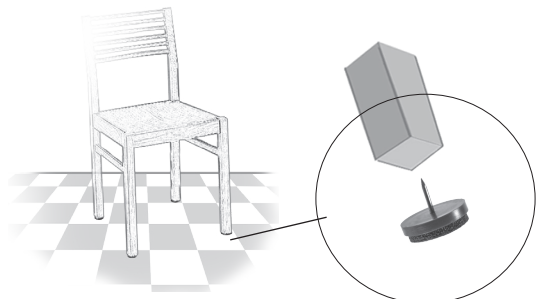

Paracolpi con chiodo e pattino in FE cromato / Buffer with nail and chrome top

PP

Codice Code	A	B	C	D	Cromato/ Chrome plated		
					€	Pz x conf Pcs/box-bag	Lotto min Min order
11.22.201.58	15	10	6	13	-	1000	2000
11.22.203.58	20	11	6	13	-	500	3000
11.22.205.58	25	12	7	13	-	500	3000
11.22.209.58	40	13	7	17	-	250	500

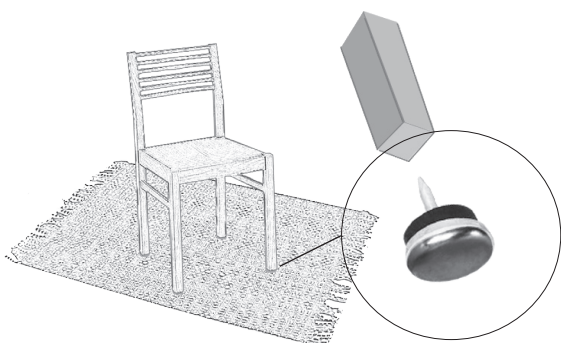

Adatto a moquette o tappeto  
Suitable for moquette or carpet

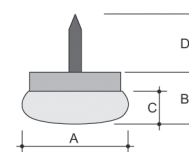

Paracolpi con chiodo e pattino in plastica / Buffer with nail and plastic top

PPP

Codice Code	A	B	C	D	Nero/ Black		
					€	Pz x conf Pcs/box-bag	Lotto min Min order
11.22.205.13	25	12	6	13	-	500	500

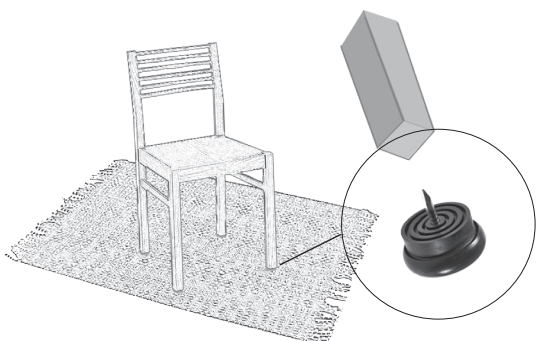

Adatto a moquette o tappeto  
Suitable for moquette or carpet

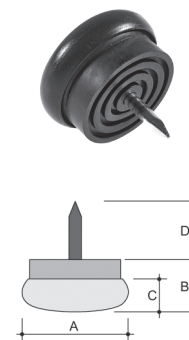

**IQC**

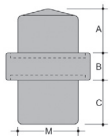

Innesto quadro per letti a castello in PA neutro  
Square connector for castle-bed in neutral PA

Codice Code	Misura Size	S.T.	A	B	C	Neutro/ Neutral		
						€	Pz x conf Pcs/box-bag	Lotto min Min order
11.23.126.05	30x30	1,5	17	11,5	19	-	500	1000
11.23.127.05	25x25	1,5	17,5	10	19	-	1500	1500

**IRC**

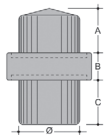

Innesto rotondo per letti a castello in PA neutro  
Round connector for castle-bed in neutral PA

Codice Code	Misura Ø	S.T.	A	B	C	Neutro/ Neutral		
						€	Pz x conf Pcs/box-bag	Lotto min Min order
11.23.128.05	28	1,5	17,0	11	18,5	-	1000	3000

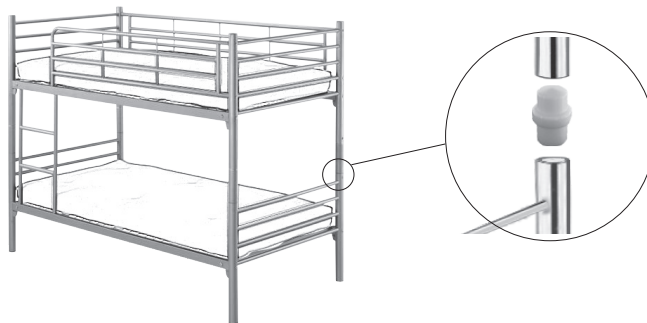

**PFB**

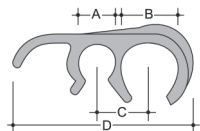

Pinze ferma brande in PP neutro / Clips in neutral PP

Codice Code	A	B	C	D	Neutro/ Neutral		
					€	Pz x conf Pcs/box-bag	Lotto min Min order
11.23.117.02	16	25	23	77	-	1000	3000

**PFB**



Pinze ferma brande in PP neutro / Clips in neutral PP

Codice Code	A	B	C	Neutro/ Neutral		
				€	Pz x conf Pcs/box-bag	Lotto min Min order
11.23.118.02	15-16	36	85	-	500	500

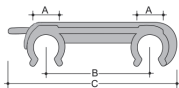

**PFB**



Pinze ferma brande in PP neutro / Clips in neutral PP

Codice Code	A	B	C	Neutro/ Neutral		
				€	Pz x conf Pcs/box-bag	Lotto min Min order
11.23.119.02	24-25	89	137	-	450	450

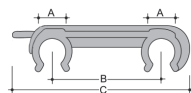

Pinze ferma brande in PP / Clips in PP

PFB

Codice Code	A	B	C	Nero/Black		
				€	Pz x conf Pcs/box-bag	Lotto min Min order
11.23.150.02	14	100	146	-	650	650

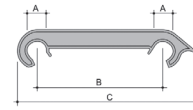

Pinze ferma brande in PP / Clips in PP

PFB

Codice Code	A	B	C	Nero/Black		
				€	Pz x conf Pcs/box-bag	Lotto min Min order
11.23.151.02	14	138	187	-	350	2100

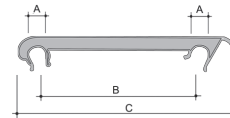

Coppia pinze regolabili per tubo ovale 15x30 in PP / Clips for oval tube 15x30 in PP

CPR

Codice Code	Tubo Tube	A max	B min	Nero/Black		
				€	Pz x conf Pcs/box-bag	Lotto min Min order
11.23.122.02	15X30	214	134	-	200	200

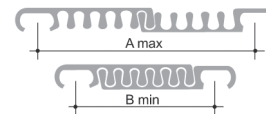

Coppia pinze regolabili per tubo Ø 18 - 20 in PP / Clips for tube Ø 18 - 20 in PP

CPRX

Codice Code	Tubo Tube	A max	B min	Nero/Black		
				€	Pz x conf Pcs/box-bag	Lotto min Min order
11.23.123.02	Ø 18-20	204	124	-	200	200

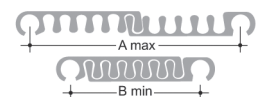

Pinza unione sedie per tubo ovale in PP nero / Clips for oval tube in black PP

PUS

Codice Code	A	B	C	Nero/Black		
				€	Pz x conf Pcs/box-bag	Lotto min Min order
11.23.120.02	15	30	60,5	-	500	500

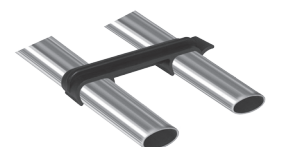
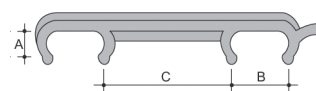

## GPL

### Giunti porta aste letti in PP nero / Connectors in black PP

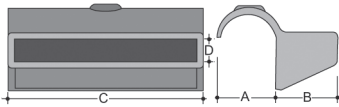

Codice Code	A	B	C	D	Nero/Black		
					€	Pz x conf Pcs/box- bag	Lotto min Min order
11.23.135.02	25	26,5	76	8	-	500	500

## GPLD

### Giunti porta aste letti doppi in PP nero / Double connectors in black PP

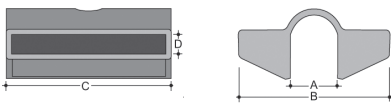

Codice Code	A	B	C	D	Nero/Black		
					€	Pz x conf Pcs/box- bag	Lotto min Min order
11.23.136.02	25	69	76	8	-	250	250

## RAR

### Reggi aste rettangolare in PE nero / Rectangular rod-trayer in black PE

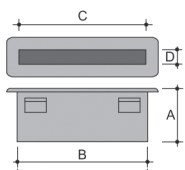

Codice Code	A	B	C	D	Nero/Black		
					€	Pz x conf Pcs/box- bag	Lotto min Min order
11.23.137.02	30	73x12,5	70	8	-	1000	3000
11.23.139.02	15	72x14	69,5	10	-	1500	1500

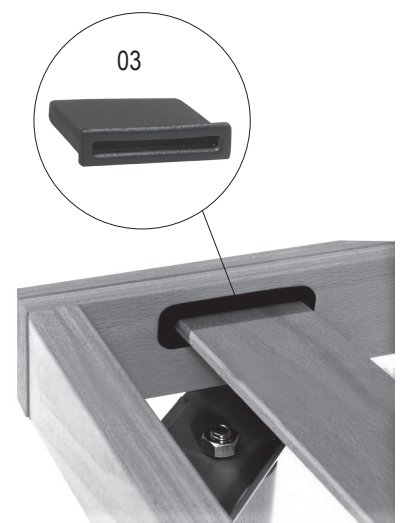
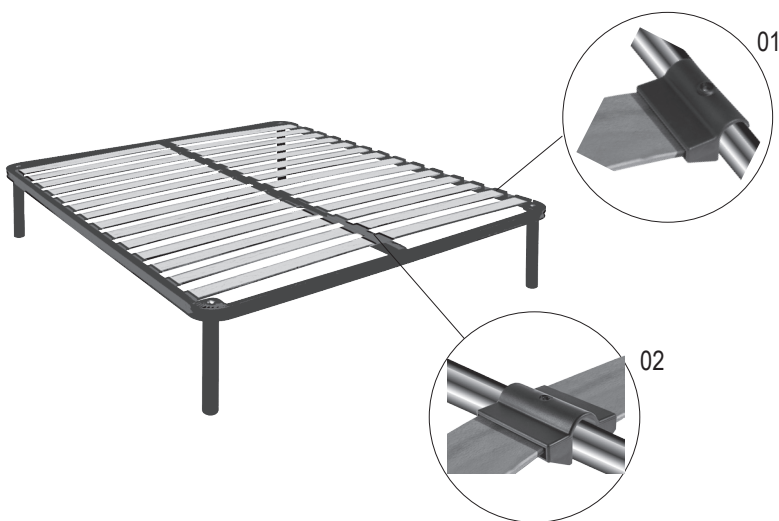

01 GPL Giunti porta aste letti in PP nero  
Connectors in black PP

02 GPLD Giunti porta aste letti doppi in PP nero  
Double connectors in black PP

03 RAR Reggi aste rettangolare in PE nero  
Rectangular rod-trayer in black PE

Copritesta per molle reti in PE neutro / Cover caps for net spring in neutral PE

CMR

Codice Code	A	B	C	D	Neutro//Neutral		
					€	Pz x conf Pcs/box-bag	Lotto min Min order
11.23.115.02	17,5	16	8	13,5	-	5000	5000

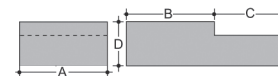

Reggi aste con pioli in PE / Rod-trayer with peg in PE

RAP

Codice Code	A	B	C	D	E	Nero/Black			Colorato/Coloured		
						€	Pz x conf Pcs/box-bag	Lotto min Min order	€	Pz x conf Pcs/box-bag	Lotto min Min order
11.23.138.02	54	9	8,5	39	30	-	1500	1500	-	1500	10500
11.23.133.02	70	9	8,5	40	36	-	1000	10000	-	-	-

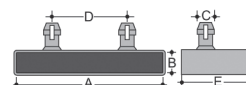

Reggi aste arcuato con pioli in PE / Arched rod-trayer with peg in PE

RAPAL

Codice Code	A	B	C	D	E	Nero/Black		
						€	Pz x conf Pcs/box-bag	Lotto min Min order
11.23.155.02	54	9	8,5	39	27	-	1500	1500

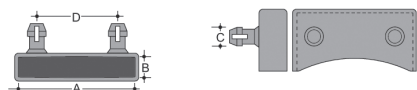

Puntali per brande inclinato 20° in PE / Inclined 20° inserts in PE

EBI

Codice Code	A	B	C	D	Nero/Black		
					€	Pz x conf Pcs/box-bag	Lotto min Min order
11.23.140.02	25	40	24	36	-	1700	5100

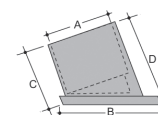

Puntali per piedi letto in PE / Inserts in PE

PPL

Codice Code	A	B	C	D	Nero/Black		
					€	Pz x conf Pcs/box-bag	Lotto min Min order
11.23.141.02	Ø 50	Ø 64	32	9,5	-	350	350

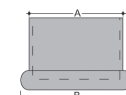

Puntale testa larga Ø40 per tubo spess.1 / Big head insert Ø40 with thickness 1 mm

PTL

Codice Code	Ø	A	B	C	D	Nero/Black		
						€	Pz x conf Pcs/box-bag	Lotto min Min order
11.01.183.02	40	38	49	20	6	-	1250	1250

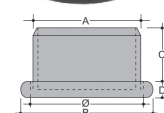

## STL

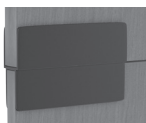

### Supporto per testate letti in PA / Support for the head of beds in PA

Codice Code	A	B	C	D	E	Bianco/ White		
						€	Pz x conf Pcs/box-bag	Lotto min Min order
11.23.125.05	14	35	15	31	8	-	1000	1000

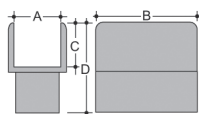

## SARE

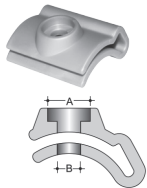

### Supporto ad arco per rete elettrosaldata / Arched support for electrowelded net

Codice Code	A	B	Grigio RAL 7040/Grey RAL 7040		
			€	Pz x conf Pcs/box-bag	Lotto min Min order
11.23.160.02	12	6,5	-	2000	2000

## SAGE

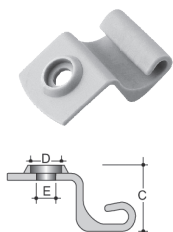

### Supporto con aggancio per rete elettrosaldata / Support with hook for electrowelded net

Codice Code	A	B	C	D	E	Grigio RAL 7040/Grey RAL 7040		
						€	Pz x conf Pcs/box-bag	Lotto min Min order
11.23.161.02	48	34	25	12	7,5	-	2000	2000

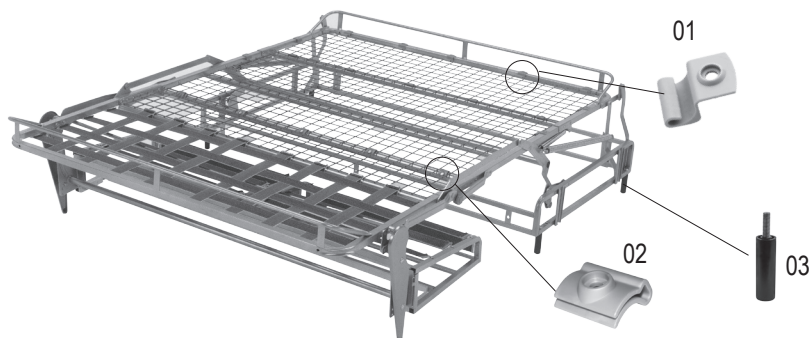

- 01 SAGE Supporto con aggancio per rete elettrosaldata / Support with hook for electrowelded net pg. 66
- 02 SARE Supporto ad arco per rete elettrosaldata / Arched support for electrowelded net pg. 66
- 03 PPML Piedino per meccanismo letto / Adjustable foot for bed mechanism pg. 120

## CRL



### Copricerniere per reti letto / Hinge cover for bed frames

Codice Code		A	B	C	D	E	F	G	Grigio RAL7040 / Grey RAL7040		
									€	Pz x conf Pcs/box-bag	Lotto min Min order
11.23.111.02	25X5 (1 foro)	28.4	35	20	25.6	8.6	11.4	/	-	-	-
11.23.112.02	30x5 (2 fori)	31.8	39.5	17	31.8	8.6	11.4	9	-	-	-

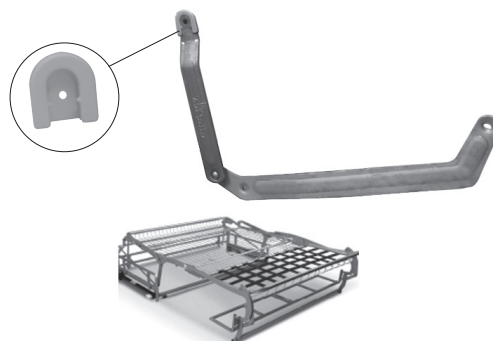
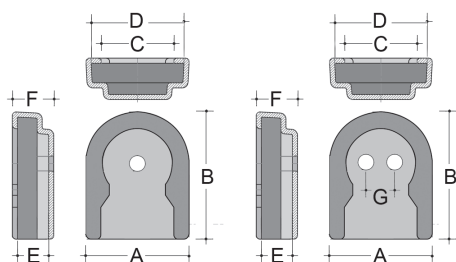

## 21 -ARTICOLI PER ATTACCAPANNI E PORTAOMBRELLI ITEMS FOR CLOTHES AND UMBRELLA STANDS

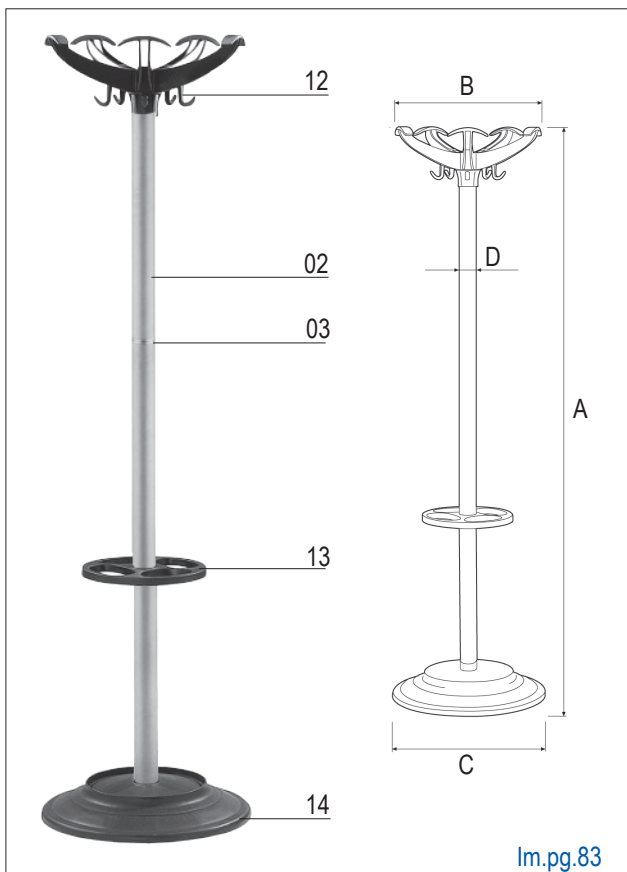
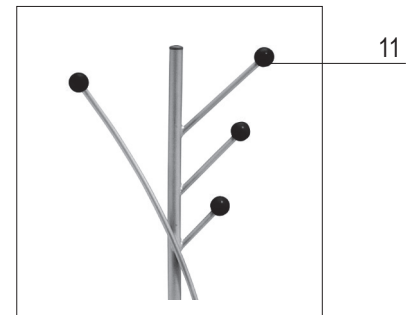
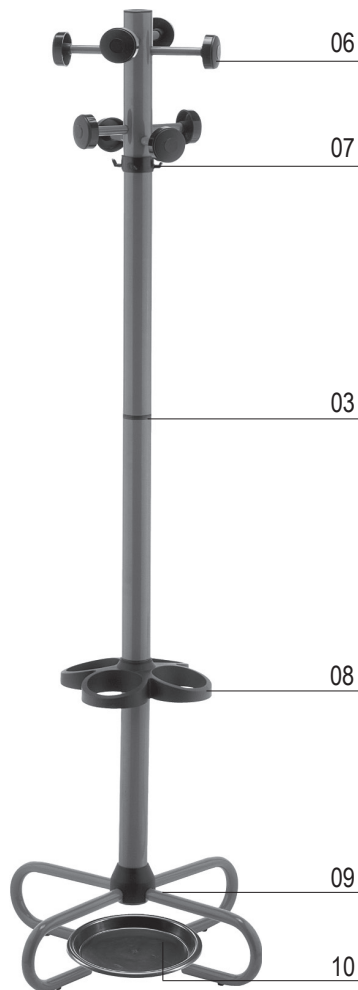
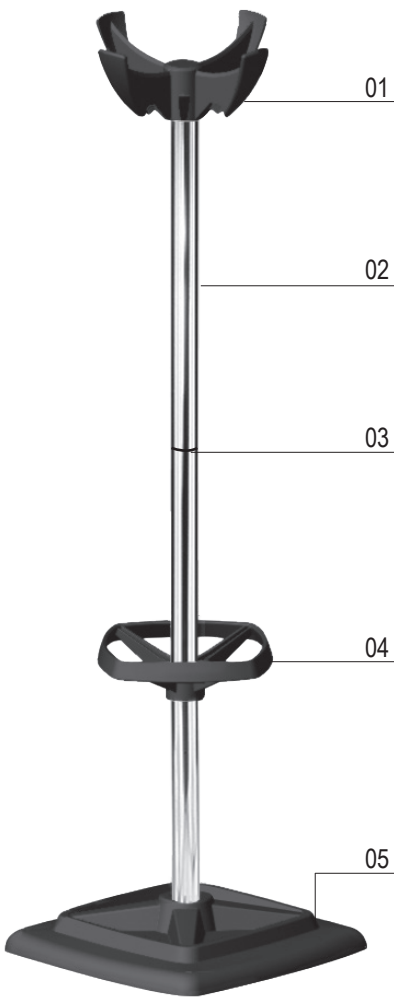

Im.pg.83

01	HA01	Appendino 4 posti TREE- Cloth hanger 4 places TREE	pg.68
02	-	Tubo fornito solo nel kit APEL/ Tube supplied only in the kit vers. APEL	-
03	ITRV+AXA+ITR	Innesto c/vite per tubi rotondi in PS+Anello per appendiabiti in PP +Innesto c/vite per tubi rotondi in PS Connector with screw for round tube+ Ring for stand clothes hanger in PP+Connector with screw for round tube	pg.71
03*	ITR(x2)+VIT	Innesto per tubi rotondi filettato in PA +Vite per innesti ITR in FE zincocromato Threaded connector for round tube in PA(x2) + Zinc plated screw for connectors ITR	pg.72
03**	GGA	Giunto girevole per attaccapanni in PS / Turning joint in PS	pg.72
04	DU01	Disco porta ombrelli TREE/ Umbrella stand plate TREE	pg.73
05	PU01	Base portaombrelli TREE/ Umbrella stand base TREE	pg.75
06	PPS	Pomello per appendiabito in ABS/ Knob for cloth hanger in ABS	pg.69
07	AP4	Appendino a 4 posti Ø50 / Cloth hanger 4 places Ø50	pg.68
08	DPOC	Disco portaombrelli 4 posti -PP/ Umbrella stand plate 4 places -PP	pg.73
09	CSA	Coprisaldatura per appendiabito/ Cover welding for cloth hanger	pg.74
10	BPO	Bacinella portaombrelli rotonda in PP/ Round umbrella basin in PP	pg.74
11	PNA	Pomello per attaccapanni- Black ball knob	pg.69
12	APP+MXA	Supporto Appendiabiti+ Mozzo per appendiabiti con copertina Clothes-hook support+ Clothes-hook with cover	pg.68
13	DPO	Disco portaombrelli 4 posti in PP/ Umbrella stand plate 4 places	pg.73
14	PORB	Base portaombrelli/ Umbrella-stand base	pg.75

Kit APEL appendiabito mod.Elix (12+02+03+13+14)

Appendiabiti a colonna con portaombrelli modello Elix  
Clothes-hanger with umbrella-stand model Elix

Code	A	B	C	D	NOTE
21.24.223.00N	1730	400	455	Ø50	nero/black
21.24.223.00C	1730	400	455	Ø50	cromato/ chromed plated

## HA01



Im.pg.67

### Appendino 4 posti TREE-Cloth hanger 4 places TREE

Codice Code	A	B	Nero/Black		
			€	Pz x conf Pcs/box-bag	Lotto min Min order
11.24.246.02	300	Ø50	-	30	500

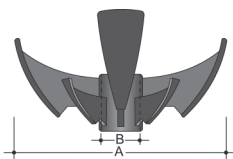

## APP

### Supporto Appendiabiti/ Clothes-hook support

Codice Code	A	B	C	D	Nero/Black		
					€	Pz x conf Pcs/box-bag	Lotto min Min order
11.24.220.05	74	Ø50	20	15	-	100	100

## MXA

### Mozzo per appendiabiti con copertina/ Clothes-hook with cover

Codice Code	E	Nero/Black		
		€	Pz x conf Pcs/box-bag	Lotto min Min order
11.24.221.05	75	-	100	100

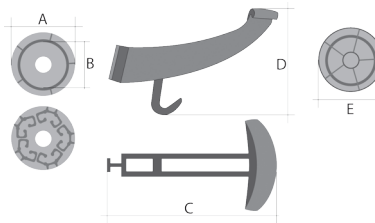
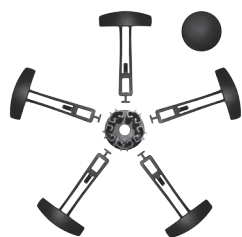

Im.pg.67

## CPA

### Copriforo tubo Ø 50 spess.1 mm per appendiabito Cover cap for tube Ø 50 for cloth hanger



Codice Code	Ø A	Ø B	S.T.	Nero/Black		
				€	Pz x conf Pcs/box-bag	Lotto min Min order
11.24.245.02	50	20	1	-	500	500

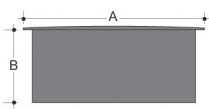

## AP4

### Appendino a 4 posti Ø50 / Cloth hanger 4 places Ø50



Im.pg.67

Codice Code	A	B	Nero/Black		
			€	Pz x conf Pcs/box-bag	Lotto min Min order
11.24.218.02	50	24	-	500	500

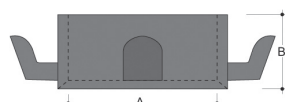

Pomelli attaccapanni in ABS / Ball knobs in ABS

PFS

Codice Code	A	B	Nero/Black			Cromato / Chrome plated		
			€	Pz x conf Pcs/box- bag	Lotto min Min order	€	Pz x conf Pcs/box- bag	Lotto min Min order
21.24.140.00	20	10MA	-	500	500	-	500	500
21.24.141.00	28	10MA	-	200	200	-	200	200
21.24.142.00	35	10MA	-	100	200	-	100	200
21.24.143.00	44	10MA	-	100	200	-	100	200
21.24.144.00	54	10MA	-	50	200	-	50	200
21.24.145.00	64	10MA	-	50	200	-	50	200
21.24.150.00	20	8MA	-	500	500	-	500	500
21.24.151.00	28	8MA	-	200	200	-	200	200
21.24.152.00	35	8MA	-	100	200	-	100	200
21.24.153.00	44	8MA	-	100	200	-	100	200
21.24.154.00	54	8MA	-	50	200	-	50	200
21.24.155.00	64	8MA	-	50	200	-	50	200

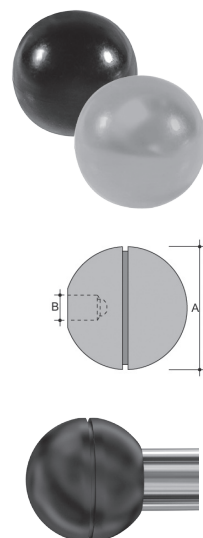

Pomelli attaccapanni in ABS / Ball knobs in ABS

PAP

Codice Code	Ø A	Ø B	Nero/Black			Cromato / Chrome plated		
			€	Pz x conf Pcs/box- bag	Lotto min Min order	€	Pz x conf Pcs/box- bag	Lotto min Min order
21.24.120.00	64	25	-	50	200	-	50	200

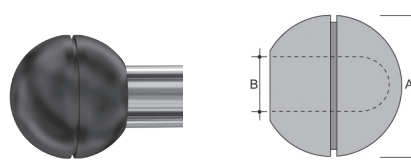

Pomolo per appendiabito in ABS / Knob for cloth hanger in ABS

PPS

Codice Code	A	B	Nero/Black		
			€	Pz x conf Pcs/box- bag	Lotto min Min order
11.24.160.04	65	16	-	800	800

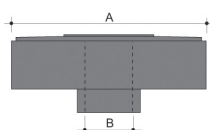

Im.pg.67

## PATC

Pomelli attaccapanni neri-PS, testa FE cromata o ottonata  
*Black knobs-PS-chromed or brassed head*

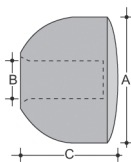

Codice Code	Ø A	Ø B	C	Nero testa in FE cromata o ottonata Black with chromed or brassed head		
				€	Pz x conf Pcs/box-bag	Lotto min Min order
11.24.188.53	50	16	39	-	250	1500
11.24.189.53	50	18	39	-	250	1500
11.24.190.53	50	20	39	-	250	1500

## ITRV

Innesto c/vite per tubi rotondi in PS / Connector with screw for round tube

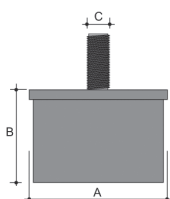

Codice Code	Ø A	Ø B	C	S.T.	Nero/Black		
					€	Pz x conf Pcs/box-bag	Lotto min Min order
11.24.217.76	50	34	8MA	1	-	300	600

## AXA

Anello per appendiabiti in PP / Ring for stand clothes hanger in PP

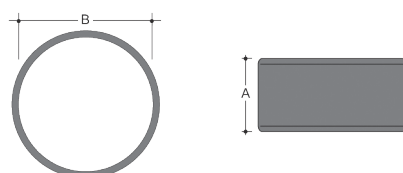

Codice Code	A	B	Nero/Black		
			€	Pz x conf Pcs/box-bag	Lotto min Min order
11.24.244.02	27	50	-	500	500

Innesto c/vite per tubi rotondi in PS / Connector with screw for round tube

Codice Code	Ø A	Ø B	C	S.T.	Nero/Black		
					€	Pz x conf Pcs/box- bag	Lotto min Min order
11.24.209.76	35	29	8MA	1	-	500	1000
21.24.210.00	40	32	8MA	1	-	100	400
11.24.211.76	50	34	8MA	1	-	600	3000
21.24.212.00	60	34	8MA	1	-	50	400

ITR

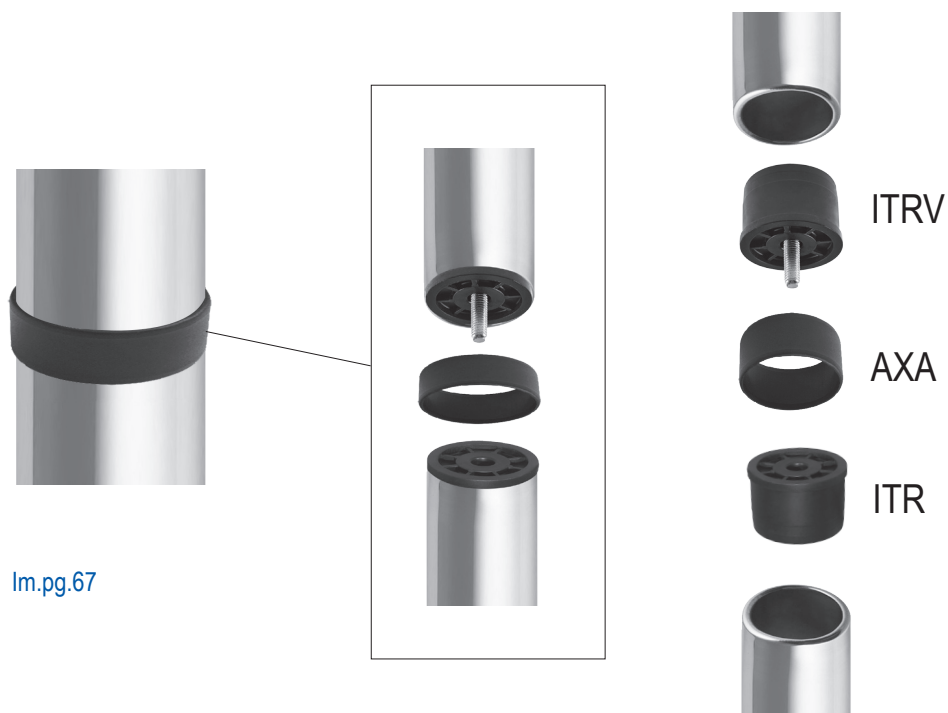
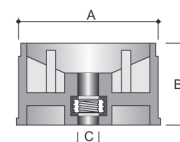

Im.pg.67

## ITR

### Innesto per tubi rotondi filettato in PA / Threaded connector for round tube in PA

Codice Code	Ø A	B	C	D	S.T.	Nero/Black		
						€	Pz x conf Pcs/box- bag	Lotto min Min order
11.24.208.05	30	4	19,5	8MA	1,2	-	1000	1000

## VIT

### Vite per innesti ITR in FE zincocromato / Zinc plated screw for connectors ITR

Codice Code	A	B	FE zincocromato / Zinc plated		
			€	Pz x conf Pcs/box- bag	Lotto min Min order
21.24.219.00	40	8MA	-	200	200

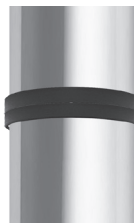
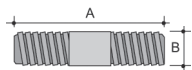
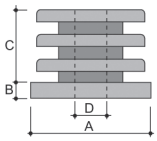

Im.pg.67

## GGA

### Giunto girevole per attaccapanni in PS / Turning joint in PS

Codice Code	Ø A	B	C	D	E	Nero/Black		
						€	Pz x conf Pcs/box- bag	Lotto min Min order
11.24.229.03	50	95	50	39	6	-	200	600

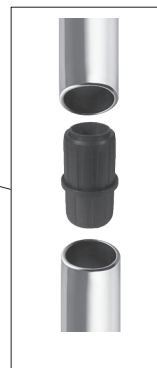
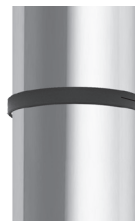
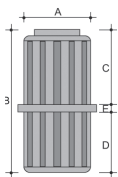

Im.pg.67

Disco porta ombrelli a 4 posti in PP / Umbrella-stand plate with 4 places in PP

Codice Code	A	B	Nero/Black		
			€	Pz x conf Pcs/box-bag	Lotto min Min order
11.24.231.02	Ø268	Ø50	-	100	100

DPO

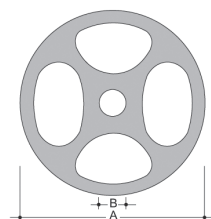

Im.pg.67

Disco porta ombrelli a 4 posti in PP/ Umbrella-stand plate with 4 places in PP

Codice Code	A	B	Nero/Black		
			€	Pz x conf Pcs/box-bag	Lotto min Min order
11.24.233.02	305	Ø50-60	-	25	500

DPOQ

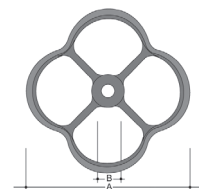

Disco porta ombrelli a 4 posti in PP / Umbrella-stand plate with 4 places in PP

Codice Code	A	B	Nero/Black		
			€	Pz x conf Pcs/box-bag	Lotto min Min order
11.24.234.02	276	Ø50	-	50	500

DPOC

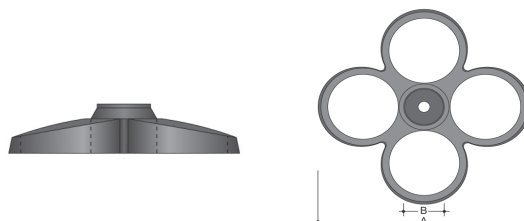

Im.pg.67

Disco porta ombrelli TREE / Umbrella-stand plate TREE

Codice Code	A	B	Nero/Black		
			€	Pz x conf Pcs/box-bag	Lotto min Min order
11.24.248.02	250	Ø50	-	15	500

DU01

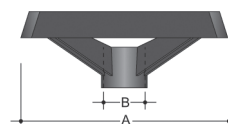

Im.pg.67

## CSA

### Coprisaldatura per appendiabito / Cover welding for cloth hanger

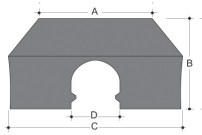

Codice Code	A	B	C	D	Nero/Black		
					€	Pz x conf Pcs/box- bag	Lotto min Min order
11.24.236.02	50	42	80	22	-	500	1000
11.24.237.02	50	60	80	22	-	250	250

Im.pg.67

## BPO

### Bacine portaombrelli rotonde in PP / Round umbrella-stand basins in PP

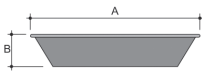

Codice Code	ØA	B	Nero/Black		
			€	Pz x conf Pcs/box- bag	Lotto min Min order
11.24.125.02	130	35	-	100	500
11.24.126.02	200	35	-	100	1000

Im.pg.67

## BPO

### Bacine portaombrelli ovali in PP / Oval umbrella-stand basins in PP

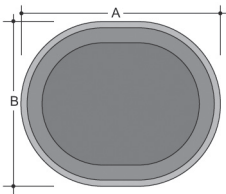

Codice Code	A	B	C	Nero/Black		
				€	Pz x conf Pcs/box- bag	Lotto min Min order
11.24.131.02	160	130	45	-	100	500

## BPO

### Bacine portaombrelli rotonde in PP / Round umbrella-stand basins in PP

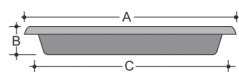

Codice Code	ØA	B	C	Nero/Black		
				€	Pz x conf Pcs/box- bag	Lotto min Min order
11.24.127.02	275	35	249	-	100	100

Base portaombrelli TREE / Umbrella-stand base Tree

PU01

Codice Code	A	B	Nero/Black		
			€	Pz x conf Pcs/box- bag	Lotto min Min order
11.26.187.02	400	Ø50	-	210	500

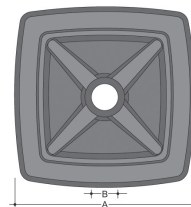

Im.pg.67

Base portaombrelli / Umbrella-stand base

PORB

Codice Code	A	B	Nero/Black		
			€	Pz x conf Pcs/box- bag	Lotto min Min order
11.26.186.02	450	Ø50	-	150	150

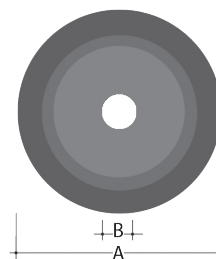

Im.pg.67

# HM01



Im.pg.83

## Appendiabito a muro TREE / Coat hook tree

Codice Code	A	B	C	D	Nero grigio RAL7040 Black grey RAL7040			Verde ice, blu ice e arancio ice Transparent green, transparent blue, transparent orange		
					€	Pz x conf Pcs/box- bag	Lotto min Min order	€	Pz x conf Pcs/box- bag	Lotto min Min order
11.24.247.02	120	64	32	84	-	200	1000	-	200	1000

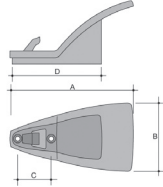

# A02



## Attaccapanni rigido in PP / Rigid clothes stand in PP

Codice Code	A	B	C	D	E	Nero, bianco RAL9003, blu RAL5015, rosso RAL3002, giallo RAL1016, verde RAL6032 Black, white RAL9003, blue RAL5015, red RAL3002, yellow RAL1016, green RAL6032			Altri colori / Other colors		
						€	Pz x conf Pcs/box- bag	Lotto min Min order	€	Pz x conf Pcs/box- bag	Lotto min Min order
11.24.102.02	117	80	32	34	84	-	300	300	-	300	2100

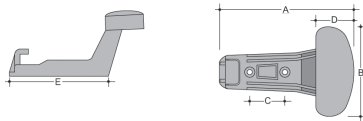

# A0



## Attaccapanni ovale in PP / Oval clothes stand in PP

Codice Code	A	B	C	D	Nero, Giallo RAL 1016			Rosso RAL 3002, Verde RAL 6032			Altri colori		
					€	Conf.	Lotto min.	€	Conf.	Lotto min.	€	Conf.	Lotto min.
11.24.101.02	131	98	55	56,5	-	300	300	-	300	600	-	300	2100

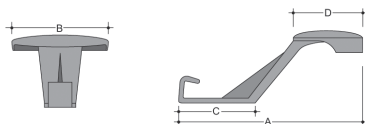



01	GAS-GASD	Griglia per armadietti spogliatoio con appendino in PST <i>Grid for lockers with cloth hanger in PST</i>	pg. 79
02	GRA	Gancetto reggipiani per armadietti <i>Shelf hook for locker</i>	pg. 79
03	GPG	Gancio porta-giacca in PA <i>Hook for jacket in PA</i>	pg. 79
04	PGO	Piastra per GPO spogliatoi in FE grezzo <i>Raw FE plate for umbrella-stand</i>	pg. 78
05	GPO	Gancio reggi ombrello spogliatoi in PP <i>Umbrella-stand in PP</i>	pg. 78
06	PAS	Piastra aggancio attaccapanni spogliatoio in FE cromato <i>Chrome FE plate for cloth hanger</i>	pg. 78
07	VPO	Vaschetta porta ombrelli per spogliatoi in PP <i>Umbrella-trayer in PP</i>	pg. 78

## PAS

### Piastra aggancio attaccapanni spogliatoio in FE cromato *Chrome FE plate for cloth hanger*

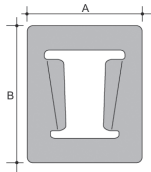
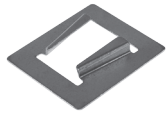

Im.pg.77

Codice Code	A	B	FE cromato / Chrome plated FE		
			€	Pz x conf Pcs/box-bag	Lotto min Min order
11.26.174.67	55	65	-	500	1000

## PGO

### Piastra per GPO spogliatoi in FE grezzo / Raw FE plate for umbrella-stand

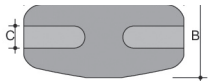

Im.pg.77

Codice Code	A	B	C	FE grezzo / Raw FE		
				€	Pz x conf Pcs/box-bag	Lotto min Min order
11.26.175.67	57	29,5	5,5	-	500	1000

## GPO

### Gancio reggi ombrello spogliatoi in PP / Umbrella-stand in PP

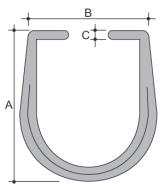

Im.pg.77

Codice Code	A	B	ØC	Grigio / Grey		
				€	Pz x conf Pcs/box-bag	Lotto min Min order
11.26.176.02	97	75	5	-	500	500

## VPO

### Vaschetta porta ombrelli per spogliatoi in PP / Umbrella-trayer in PP

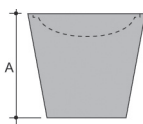
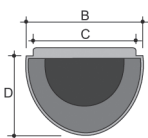

Im.pg.77

Codice Code	A	B	C	C	Grigio / Grey		
					€	Pz x conf Pcs/box-bag	Lotto min Min order
11.26.173.02	59	67	58,5	48	-	500	500

Gancio porta-giacca in PA / Hook for jacket in PA

Codice Code	A	B	C	D	Nero/Black		
					€	Pz x conf Pcs/box-bag	Lotto min Min order
11.26.190.05	18,5	54,5	24	26	-	1000	3000

GPG

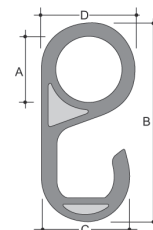

Im.pg.77

Gancetto reggipiani per armadietti / Shelf hook for locker

Codice Code	A	B	C	D	E	F	Nero/Black		
							€	Pz x conf Pcs/box-bag	Lotto min Min order
11.26.191.05	9,5	7	2,5	1	16	9	-	5000	10000

GRA

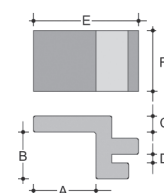

Im.pg.77

Griglia per armadietti spogliatoio con appendino in PST  
Grid for lockers with cloth hanger in PST

Codice Code	A	B	C	D	Nero/Black		
					€	Pz x conf Pcs/box-bag	Lotto min Min order
11.26.194.03	300	324	16	86	-	20	1000

GAS

Griglia per armadietti spogliatoio con appendino in PST  
Grid for locker with cloth hanger in PST

Codice Code	A	B	C	D	Nero/Black		
					€	Pz x conf Pcs/box-bag	Lotto min Min order
11.26.193.03	300	354	16	86	-	20	1000

GASD

Im.pg.77

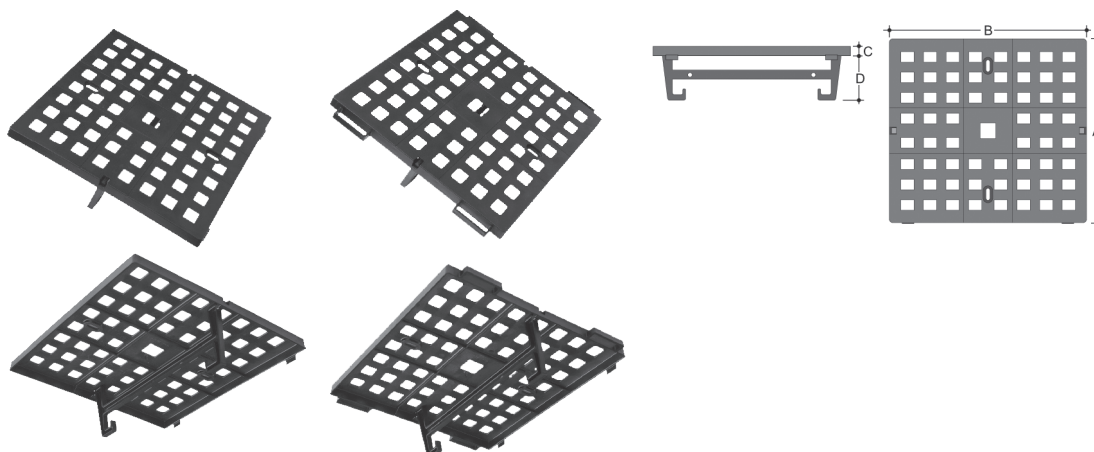

## VG

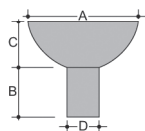

### Ventose con gambo forato in PVC / Buffers with drilled bolt in PVC

Codice Code	ØA	B	C	ØD	Trasparente/Transparent			Nero/Black			Bianco / White		
					€	Pz x conf Pcs/box-bag	Lotto min Min order	€	Pz x conf Pcs/box-bag	Lotto min Min order	€	Pz x conf Pcs/box-bag	Lotto min Min order
11.25.101.01	15	10	4	6	-	5000	5000	-	5000	50000	-	5000	50000
11.25.102.01	20	8,5	6,5	6	-	5000	5000	-	5000	50000	-	5000	50000



## VS

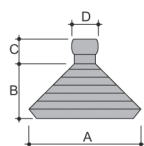

### Ventose con sfera in PVC / Buffers with ball in PVC

Codice Code	ØA	B	C	ØD	Trasparente/Transparent			Nero/Black			Bianco / White		
					€	Pz x conf Pcs/box-bag	Lotto min Min order	€	Pz x conf Pcs/box-bag	Lotto min Min order	€	Pz x conf Pcs/box-bag	Lotto min Min order
11.25.105.01	20	10	4	6	-	5000	5000	-	5000	50000	-	5000	50000
11.25.106.01	25	12	5	7	-	5000	5000	-	5000	50000	-	5000	50000
11.25.107.01	30	13	6	8	-	5000	5000	-	5000	50000	-	5000	50000



## RR



### Riduttore alettato in PE per rotelle / PE adapters for castors

Codice Code	Tubo esterno Ext tube size	ØA	ØB	C	S.T.	Nero/Black		
						€	Pz x conf Pcs/box-bag	Lotto min Min order
11.25.111.02	14	12	8	24	1	-	2000	4000
11.25.112.02	16	14	8	24	1	-	1500	1500
11.25.113.02	18	16	8	24	1	-	1500	4500
11.25.114.02	20	18	8	24	1	-	1500	1500
11.25.115.02	22	20	8	24	1	-	1000	1000
11.25.116.02	25	23	8	24	1	-	1000	1000
11.25.117.02	28	26	8	24	1	-	1000	3000

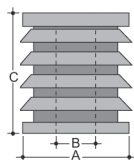

Riduttori rigati per ruote in PP / Striped adapter for castors in PP

3R

Codice Code	ØA	ØB	S.T.	ØC	D	Nero/Black		
						€	Pz x conf Pcs/box- bag	Lotto min Min order
11.25.190.02	20	17	1,5	10	34	-	2000	2000
11.25.191.02	20	17	1,5	11	34	-	2000	2000
11.25.127.02	22	19	1,5	10	34	-	2000	6000
11.25.128.02	22	19	1,5	11	34	-	2000	4000
11.25.192.02	25	22	1,5	10	34	-	2000	2000
11.25.193.02	25	22	1,2-1,5	11	34	-	2000	2000
11.25.194.02	28	25	1,5	10	34	-	1500	1500
11.25.195.02	28	25	1,5	11	34	-	1500	1500
11.25.197.02	22	18	2	11	34	-	2000	4000

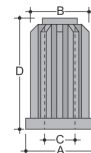

Riduttore per perno godronato in PP / Reducer for knurl pin in PP

RML

Codice Code	A	B	C	D	E	Nero/Black		
						€	Pz x conf Pcs/box- bag	Lotto min Min order
11.25.185.02	13	10	8	23	3,5	-	2000	10000

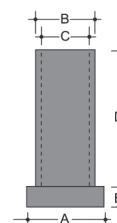

Riduttore per bloccaggio viti in PE / PE adapter for the blocking of screws

RBV

Codice Code	A	B	C			Nero/Black			Bianco / White		
						€	Pz x conf Pcs/box- bag	Lotto min Min order	€	Pz x conf Pcs/box- bag	Lotto min Min order
11.25.177.02	14	8	27	5	1	-	4000	4000	-	4000	8000
11.25.178.02	16	8	27	5	1	-	4000	4000	-	4000	8000
11.25.179.02	18	8	27	5	1	-	4000	4000	-	4000	8000

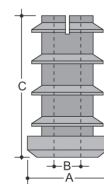

# FCV

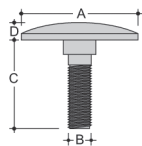

## Fermacristalli-vite in FE-testa cromata o ottonata Glass blocking -FE screws-head chromed/brassed

Codice Code	ØA	ØB	C	D	Nero/Black			Cromato Ottonato Chrome plated Brass plated		
					€	Pz x conf Pcs/box- bag	Lotto min Min order	€	Pz x conf Pcs/box- bag	Lotto min Min order
21.25.240.00	35	8	26	5	-	100	400	-	100	400
21.25.241.00	50	8	26	5	-	50	400	-	50	400
21.25.242.00	60	8	26	5	-	50	300	-	50	300

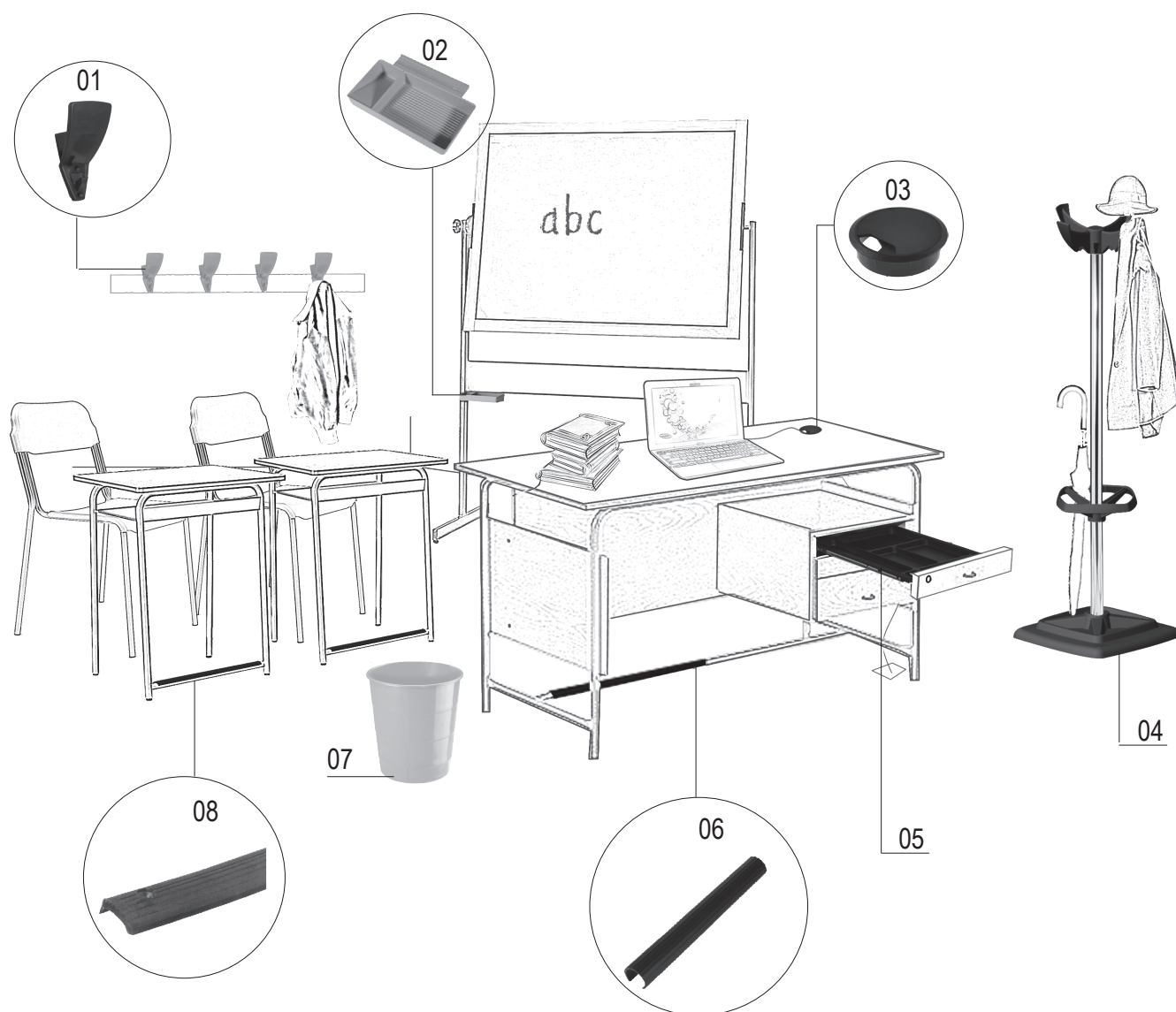

01	HM01	Appendiabito a muro TREE / Coat hook tree	pg. 76
02	VLG	Vaschetta lavagna porta gesso in PP / Chalk tray in PP	pg. 84
03	PCS	Passacavo per scrivania in PS / Cable duct for desk in PS	pg. 85
04	TREE	Appendiabiti a colonna TREE / Clothes-hanger with umbrella-stand TREE	pg. 67
05	-	Cassetto portaoggetti / Object tray	pg. 92
06	PPG	Profilato rotondo in PVC rigido / Profile covers in rigid PVC	pg. 84
07	CESG	Cestino getta carta in PP / Paper basket in PP	pg. 94
08	PGP	Poggiapiedi in PE con fori svasati per viti / Foot-rest with holes for screws in PE	pg. 84

## PGP

### Poggiapiedi in PE con fori svasati per viti / Foot-rest with holes for screws in PE



Codice Code	Ø Tubo Ø Tube	Lunghezza A Length A	Nero/Black		
			€	Pz x conf Pcs/box- bag	Lotto min Min order
11.26.101.02	14 a 16	330	-	300	300
11.26.102.02	24 a 28	320	-	300	300
11.26.103.02	24 a 28	400	-	300	300
11.26.104.02	24 a 28	500	-	300	300

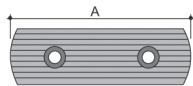

Im.pg.83

## VLG

### Vaschetta lavagna porta gesso in PP / Chalk tray in PP

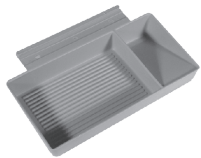

Codice Code	A	B	C	D	Grigio / Grey		
					€	Pz x conf Pcs/box- bag	Lotto min Min order
11.26.108.02	192	188	98	50	-	50	100

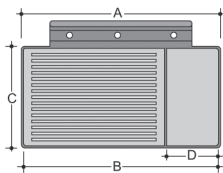

Im.pg.83

## PPG

### Profilato rotondo in PVC rigido / Profile covers in rigid PVC



Codice Code	ØA	Nero/Black			Metallizzato / Metal plated		
		€ / m	Pz x conf Pcs/box- bag	Lotto min Min order	€ / m	Pz x conf Pcs/box- bag	Lotto min Min order
21.26.200.00	10	-	200 m	200 m	-	200 m	200 m
21.26.201.00	12	-	200 m	200 m	-	200 m	200 m
21.26.202.00	14	-	200 m	200 m	-	200 m	200 m
21.26.203.00	16	-	150 m	150 m	-	150 m	150 m
21.26.204.00	18	-	100 m	100 m	-	100 m	100 m
21.26.205.00	20	-	100 m	100 m	-	100 m	100 m
21.26.206.00	22	-	100 m	100 m	-	100 m	100 m
21.26.207.00	25	-	100 m	100 m	-	100 m	100 m
21.26.208.00	28	-	50 m	50 m	-	50 m	50 m
21.26.209.00	30	-	50 m	50 m	-	50 m	50 m
21.26.210.00	35	-	50 m	50 m	-	50 m	50 m

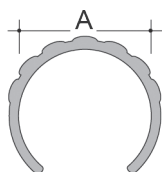

Im.pg.83

Profilato poggiapiedi a pinza in PVC rigido. Colore nero o metallizzato, in verghe da mt.2. Si possono fornire verghe tagliate a misura con costo di €0,08 al taglio.  
Bar of 2 meters length colour black or metal plated, different sizes are on request at cost of €0,08 each cut.

## Profilato quadro e rettangolare-PVC rigido/Rectangular square cover profile-rigid PVC

Codice Code	A	B	Nero/Black			Metallizzato / Metal plated		
			€/m	Pz x conf Pcs/box- bag	Lotto min Min order	€/m	Pz x conf Pcs/box- bag	Lotto min Min order
21.26.220.00	20	20	-	100 mt.	100 mt.	-	100 mt.	100 mt.
21.26.221.00	25	25	-	64 mt.	64 mt.	-	64 mt.	64 mt.
21.26.222.00	30	30	-	64 mt.	64 mt.	-	64 mt.	64 mt.
21.26.223.00	40	20	-	48 mt.	48 mt.	-	48 mt.	48 mt.

Profilato poggiatesta a pinza in PVC rigido.

Colore nero o metallizzato, in verghe da mt.2. Si possono fornire verghe tagliate a misura con costo di €0,08 al taglio.  
Bar of 2 meters length colour black or metallized, different sizes are on request at cost of €0,08 each cut

## PQR

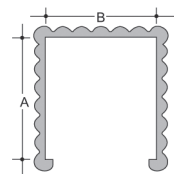
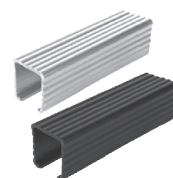

## Passacavo per scrivania in PS / Cable ducts for desk in PS

Codice Code	A	B	C	D	Nero/Black			White /Bianco		
					€	Pz x conf Pcs/box- bag	Lotto min Min order	€	Pz x conf Pcs/box- bag	Lotto min Min order
11.26.180.03	72	60	3	21	-	250	250	-	250	3000
11.26.181.03	91	80	4	21	-	75	75	-	75	3000

## PCS

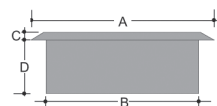

Im.pg.83

## Cuscinetti a sfera in PA (Adatti per cassetti ecc.) Ball bearing in PA (Suitable for drawers and etc.)

Codice Code	ØA	ØB	C	D	E	Neutro/Neutral		
						€	Pz x conf Pcs/box- bag	Lotto min Min order
21.26.131.00	23	6	8	8	7	-	1000	1000
21.26.132.00	25	6	8	8	7	-	1000	1000
21.26.133.00	28	6	8	8	7	-	1000	1000
21.26.134.00	30	6	8,5	10	7	-	1000	1000

## CSO

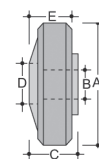

## CSL

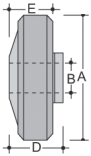

Cuscinetti per rivettatura a strappo in PA testa liscia (Adatti per cassetti ecc.)  
*Ball bearings in PA with smooth head (Suitable for drawers and etc.)*

Codice Code	ØA	ØB	C	D	Neutro / Neutral		
					€	Pz x conf Pcs/box- bag	Lotto min Min order
21.26.112.00	23	5	7	10	-	1000	1000
21.26.113.00	25	5	7	10	-	1000	1000
21.26.114.00	28	5	7	10	-	1000	1000

## CSS

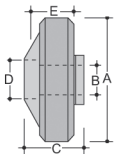

Cuscinetti per rivettatura a strappo in PA (Adatti per cassetti ecc.)  
*Ball bearings in PA (Suitable for drawers and etc.)*

Codice Code	ØA	ØB	C	D	E	Neutro / Neutral		
						€	Pz x conf Pcs/box- bag	Lotto min Min order
21.26.165.00	23	5	12	12	8,5	-	1000	1000
21.26.166.00	25	5	12	12	8,5	-	1000	1000
21.26.167.00	28	5	12	12	8,5	-	1000	1000

## VC

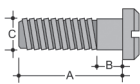

Vite per cuscinetti in FE zincato / *Zinc plated screw for bearings*

Codice Code	A	B	ØC	FE zincato / Zinc plated		
				€	Pz x conf Pcs/box- bag	Lotto min Min order
11.26.137.65	15	5	6	-	1000	1000

## RC

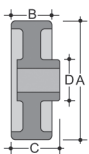

Rotelle cassetti in PA (Adatti per cassetti ecc.)  
*Drawer castors in PA (Suitable for drawers and etc.)*

Codice Code	ØA	B	C	ØD	Neutro / Neutral		
					€	Pz x conf Pcs/box- bag	Lotto min Min order
11.26.140.05	27	10,5	11,5	8	-	1000	5000

Perno per rotella RC in PA colore neutro / Pivot for castors in neutral PA

Codice Code	A	B	C	ØD	ØE	Neutro / Neutral		
						€	Pz x conf Pcs/box- bag	Lotto min Min order
11.26.141.05	13	10	12	5	8	-	1000	5000

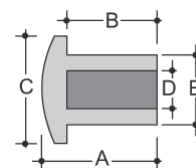

PR

Mensola reggipiano in PA neutro / Shelf in neutral PA

Codice Code	A	B	C	Neutro / Neutral		
				€	Pz x conf Pcs/box- bag	Lotto min Min order
11.26.127.05	21x24,5	3,5x15,5	9,5	-	2000	2000

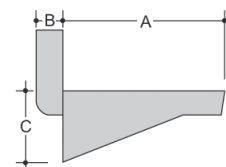

MR

## PORTAOGGETTI REGOLABILE PER CASSETTO *OBJECT TRAYER FOR DESK*

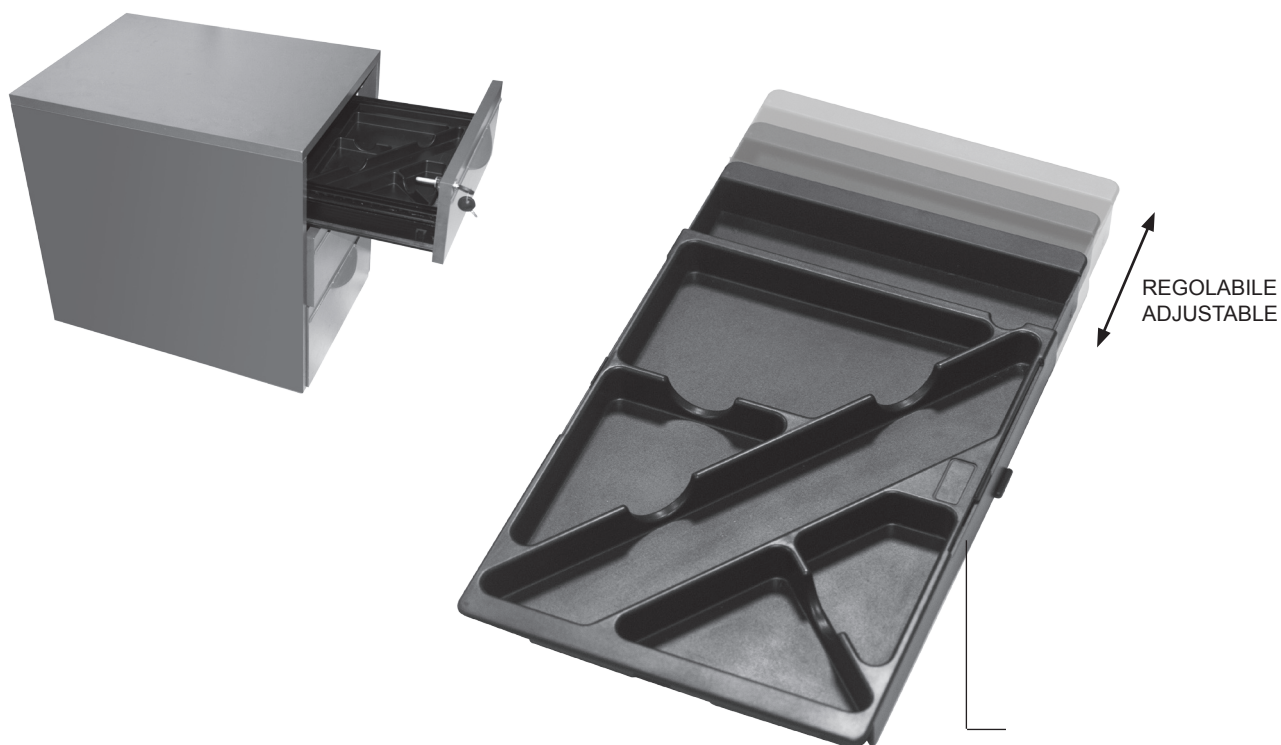

01 POSR portaoggetti regolabile per cassetto scrivania / *Adjustable object trayer for desk* pg.91



Porta oggetti cassetti scrivania in PS / Objects-tray for desk in PS

POS

Codice Code	A	B	C	D	Nero/Black		
					€	Pz x conf Pcs/box- bag	Lotto min Min order
11.26.123.03	349	168	18	327	-	40	40

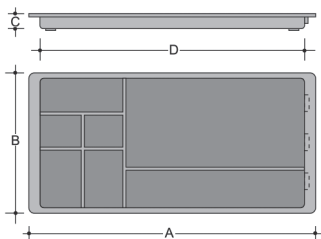

Porta oggetti cassetti scrivania con fermo in PS / Objects-tray with blocking in PS

POSF

Codice Code	A	B	C	D	E	F	G	Nero/Black		
								€	Pz x conf Pcs/box- bag	Lotto min Min order
11.26.122.03	349	168	18	327	156	2	6,5	-	40	1000

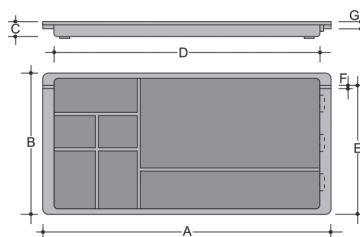

Porta oggetti cassetti scrivania in PS / Objects-tray for desk in PS

POSL

Codice Code	A	B	C	D	E	F	Nero/Black		
							€	Pz x conf Pcs/box- bag	Lotto min Min order
11.26.121.03	349	168	18	327	342	363	-	40	500

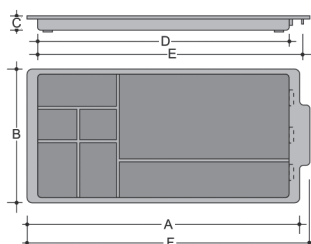

# POSG

## Porta oggetti cassetti scrivania in PS / Objects-trayer for desk in PS

Codice Code	A	B	C	D	Nero/Black		
					€	Pz x conf Pcs/box- bag	Lotto min Min order
11.26.126.03	350	200	22	325	-	40	40

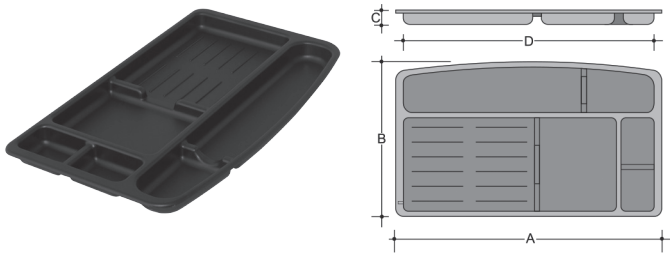

# POSGF

## Porta oggetti cassetti scrivania in PS / Objects-trayer for desk in PS

Codice Code	A	B	C	D	E	F	G	Nero/Black		
								€	Pz x conf Pcs/box- bag	Lotto min Min order
11.26.130.03	350	200	22	325	181	2,5	5,5	-	40	500

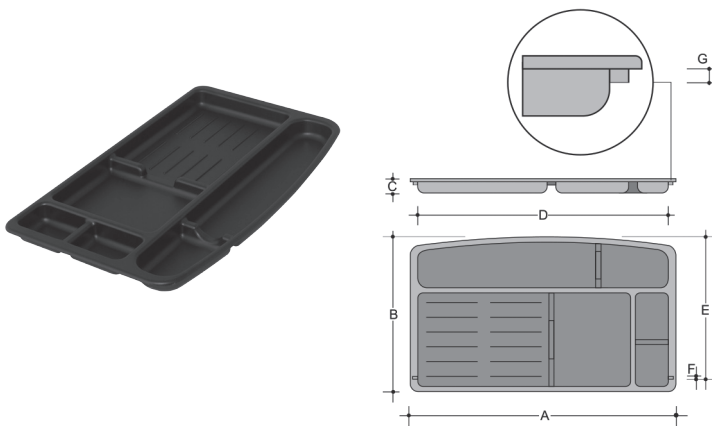

# POSGL

## Porta oggetti cassetti scrivania in PS / Objects-trayer for desk in PS

Codice Code	A	B	C	D	E	F	G	Nero/Black		
								€	Pz x conf Pcs/box- bag	Lotto min Min order
11.26.135.03	350	200	22	325	2	8	2	-	40	40

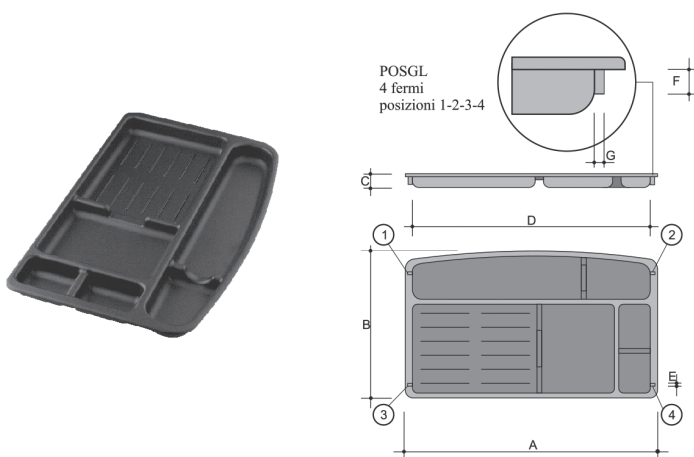

Portaoggetti cassetti scrivania con fermo in PS *Objects-trayer with blocking in PS*

POSGS

Codice Code	A	B	C	D	E	F	G	H	Nero/Black		
									€	Pz x conf Pcs/box- bag	Lotto min Min order
11.26.136.03	350	200	22	325	1,5	8	6	3	-	40	500

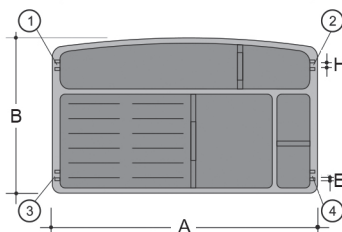
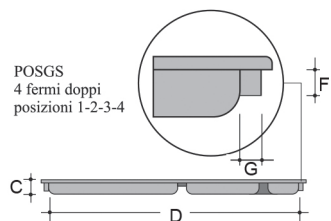

Portaoggetti con cassetto regolabile per scrivania *Objects-trayer with adjustable drawer for desk*

POSR

Codice Code	A max	B min	C	D	E max	F min	Nero/Black		
							€	Pz x conf Pcs/box- bag	Lotto min Min order
11.26.124.03	451	327	223	28	417	293	-	20	20

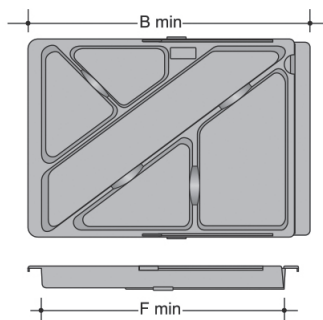
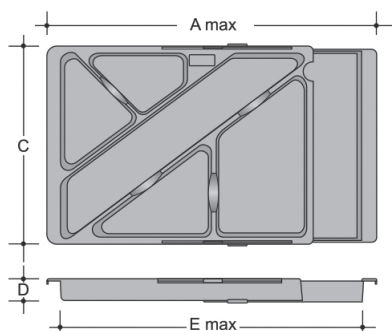

# CASSETTO PORTAOGGETTI OBJECT TRAY



Im.pg.83

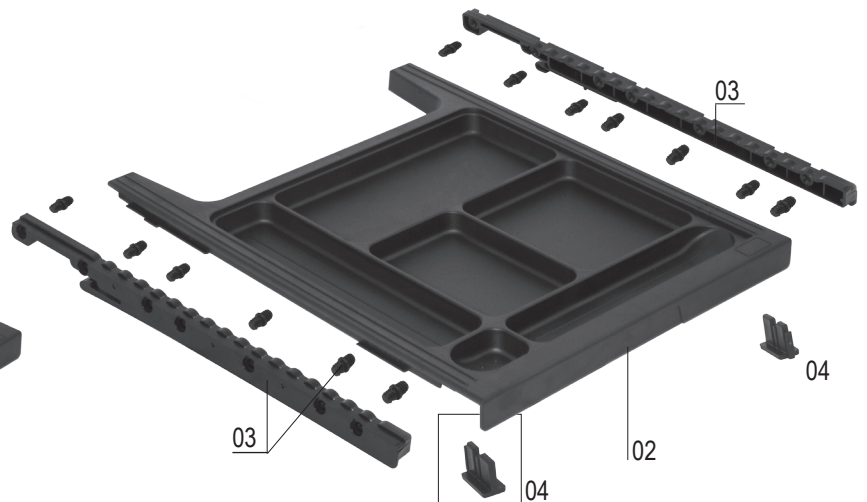
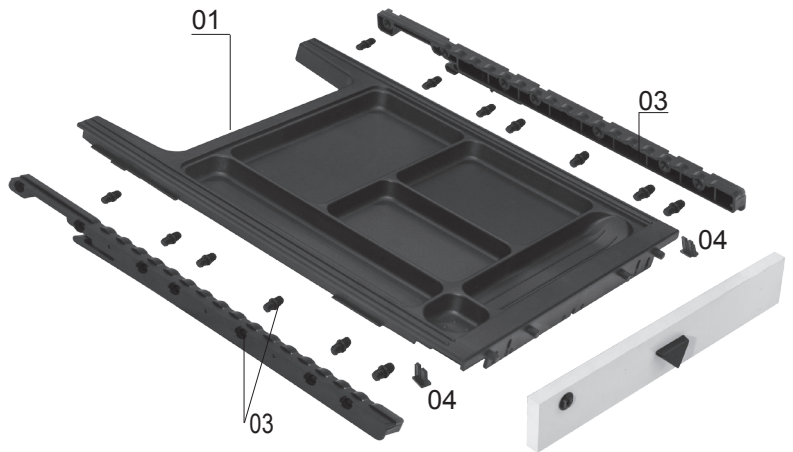

01	CPOP Cassetto portaoggetti scorrevole con pioli nero <i>Sliding object tray with pags-black</i>	pg.93
02	CPO Cassetto portaoggetti scorrevole nero <i>Sliding object tray -black</i>	pg.93
03	GCS Cop.guide c/pioli per cassetto scorrevole nero <i>Pair of guides for object tray -black</i>	pg.93
04	FCPO Fermo per cassetto portaoggetti / Stop for objects trayer	pg.93

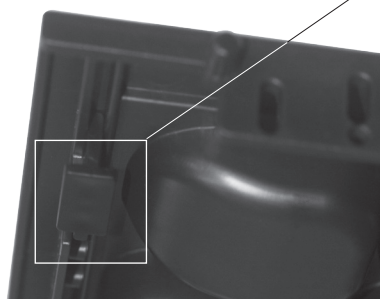

Cassetto portaogg scorrev. con pioli e fermo  
Objects-trayer with pags with stop for objects trayer

Codice Code	A	B	C	D	Nero/Black		
					€	Pz x conf Pcs/box- bag	Lotto min Min order
11.26.230.03	500	400	370	30	-	20	20

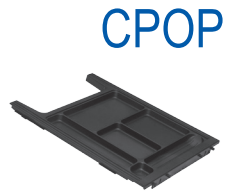

CPO

Cassetto portaogg scorrev. e fermo  
Objects-trayer with stop for objects trayer

Codice Code	A	B	C	D	Nero/Black		
					€	Pz x conf Pcs/box- bag	Lotto min Min order
11.26.231.03	500	400	370	30	-	20	20



GCS

Cop.guide con pioli per cassetto portaogg. / Pair of guides for objects-trayer

Codice Code	A	B	C	Nero/Black		
				€	Pz x conf Pcs/box- bag	Lotto min Min order
11.26.232.03	365	64	32	-	40	40

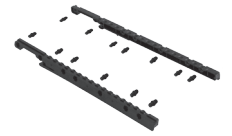

FCPO

Fermo per cassetto portaoggetti / Stop for objects trayer

Codice Code	A	B	C	Nero/Black		
				€	Pz x conf Pcs/box- bag	Lotto min Min order
11.26.233.02	28	19	13	-	-	-

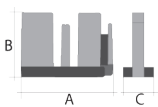
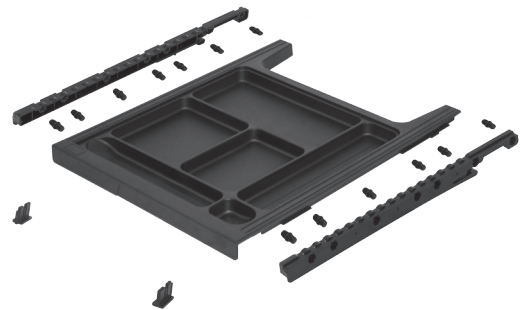
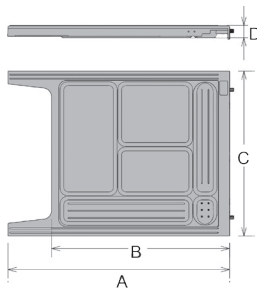
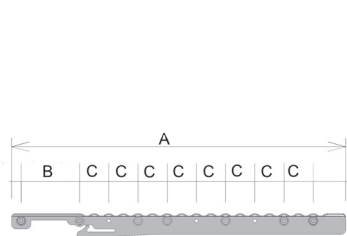

# CESG

## Cestino getta carta in PP / Paper basket in PP

Codice Code	ØA	B	Nero/Black			Colorato / Different colours		
			€	Pz x conf Pcs/box- bag	Lotto min Min order	€	Pz x conf Pcs/box- bag	Lotto min Min order
19.12.150.02	295	315	-	30	30	-	30	510

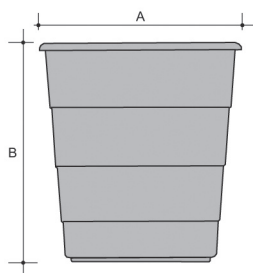

Im.pg.83

# PODI

## Vaschetta portadocumenti impilabile / Stackable document tray

Codice Code	A	B	C	Nero/Black		
				€	Pz x conf Pcs/box- bag	Lotto min Min order
11.26.199.03	365	248	73	-	20	500

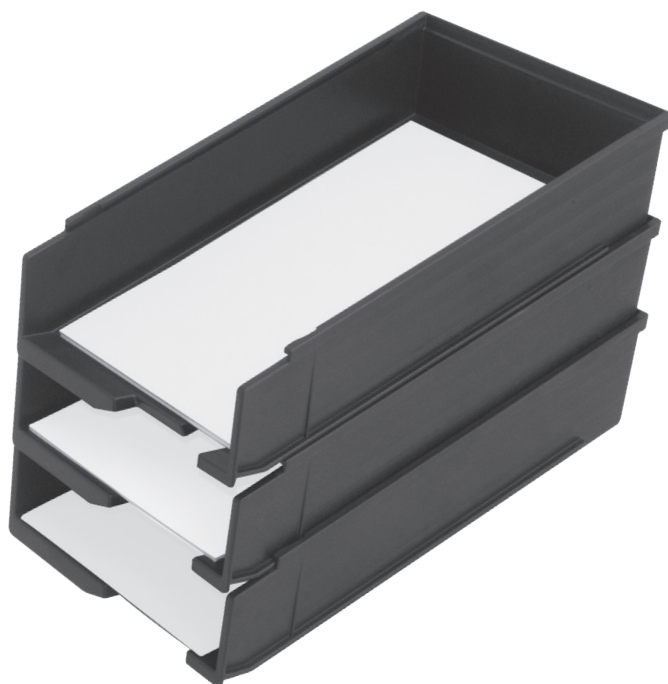
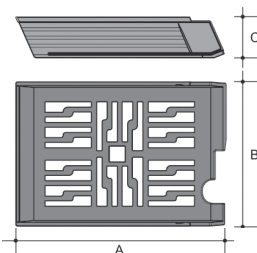

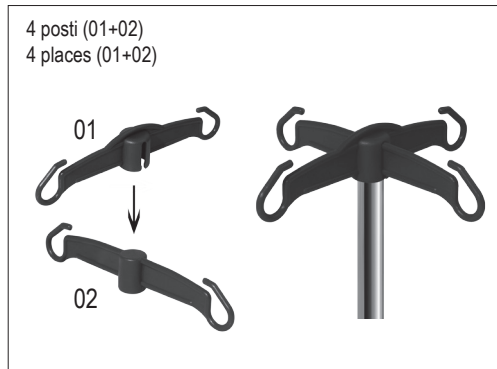
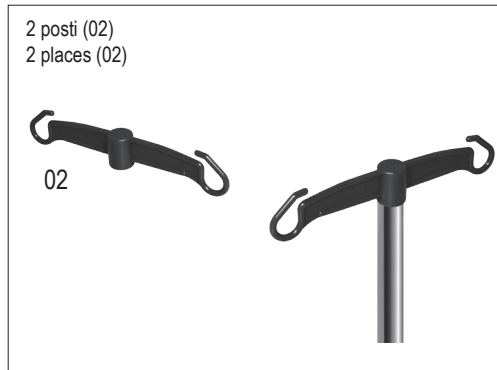
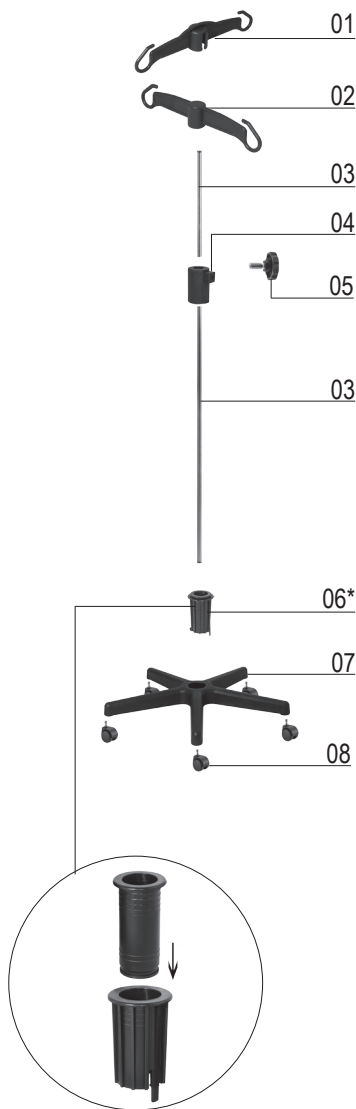

01	ASPF	ASPF	Attacco superiore porta flebo / Top joint for drip tray	pg.96
02	APF2	APF2	Appendino porta flebo 2 posti / Drip bag tray 2 places	pg.96
03	-	-	Tubo (non fornito) / Tube (not supplied)	-
04	IPF	IPF	Innesto porta flebo / Junction for medical drip bag tray	pg.96
05	11.41.151.40	VGf	Volantino con gambo filettato in PS antiurto <i>Star knobs with threaded bolt</i>	pg.108
06*	21.30.001.00N 21.30.001.00N	RBSS	Riduzione per basi cono Ø 50 con linguetta di smontaggio <i>Reduction for base cone Ø 50 with disassembling tongue</i>	pg.97
07	11.20.351.05N	BMS	Base mod. Svezia in nylon 30% FV <i>Base model Svezia in nylon 30% FG</i>	(vd catalogo componenti) <i>(component catalogue)</i>
08	11.25.307.80N4	DRG	Doppia ruota Ø50 in PA (roller) <i>PA twin wheel castor Ø50 (roller)</i>	pg.137

\* 06 IN ALTERNATIVA

06**	11.20.440.02 11.20.441.02	RBS	Riduzione per basi cono Ø 50 completa di ghiera <i>Reduction for base cone Ø 50 complete with ring</i>
06***	21.30.004.00N 21.30.006.00N	RBSL	Riduzione per basi cono Ø 50 senza linguetta di smontaggio <i>Reduction for base cone Ø 50 with disassembling tongue</i>

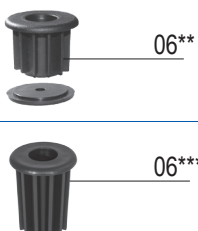

## IPF

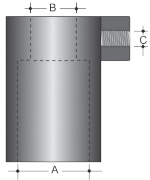

### Innesto porta flebo / Joint for drip bag tray

Codice Code	A	B	C	Nero/Black			Bianco / White		
				€	Pz x conf Pcs/box-bag	Lotto min Min order	€	Pz x conf Pcs/box-bag	Lotto min Min order
11.26.249.05	25	12	M8	-	300	300	-	300	5100
11.26.245.05	25	16	M8	-	300	300	-	300	5100
11.26.246.05	25	18	M8	-	300	300	-	300	5100
11.26.247.05	28	16	M8	-	300	300	-	300	5100
11.26.248.05	28	18	M8	-	300	1000	-	300	5100

## APF2

### Appendino porta flebo 2 posti / Drip bag trayer 2 places

Codice Code	A	B	Nero/Black			Colorato / Coloured		
			€	Pz x conf Pcs/box-bag	Lotto min Min order	€	Pz x conf Pcs/box-bag	Lotto min Min order
21.26.242.00	232	16	-	450	450	-	450	2700
21.26.243.00	232	18	-	450	450	-	450	2700

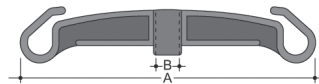

## ASPF

### Attacco superiore porta flebo / Top joint for drip trayer

Codice Code	A	Nero/Black			Colorato / Coloured		
		€	Pz x conf Pcs/box-bag	Lotto min Min order	€	Pz x conf Pcs/box-bag	Lotto min Min order
21.26.244.00	232	-	450	450	-	450	2700

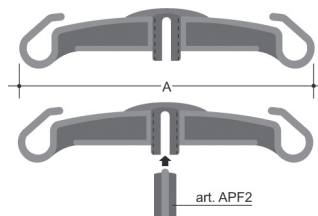

Riduz. per basi cono Ø50 con di ghiera /Reduction for base cone Ø50 with ring

RBS

Codice Code	A	B	C	D	E	F	Nero/Black		
							€	Pz x conf Pcs/box-bag	Lotto min Min order
11.20.440.02	25	60	48	5	41	9	-	300	300
11.20.441.02	28	60	48	5	41	9	-	300	300

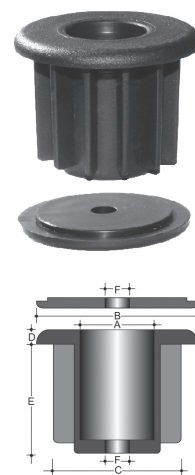

Riduzione per basi cono Ø 50 con linguetta di smontaggio  
Reduction for base cone Ø 50 with disassembling tongue

RBSS

Codice Code	A	B	C	D	E	F	Nero/Black		
							€	Pz x conf Pcs/box-bag	Lotto min Min order
21.30.001.00	56	49,5	25	6	77	78	-	100	1000
21.30.003.00	56	49,5	30	6	77	78	-	100	1000



Riduzione per basi cono 50 senza linguetta smontaggio  
Reduction for base cone Ø 50 without disassembling tongue

RBSL

Codice Code	A	B	C	D	E	F	Nero/Black		
							€	Pz x conf Pcs/box-bag	Lotto min Min order
21.30.004.00	56	49,5	25	6	77	78	-	250	1000
21.30.006.00	56	49,5	30	6	77	78	-	250	1000

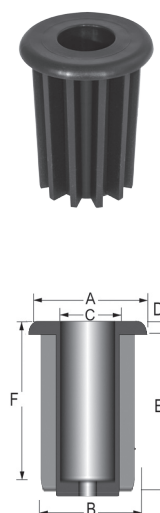

## PCP

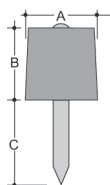

Poggiapiani con chiodo passante in PS antiurto / Holder shelf in PS with nail passing

Codice Code	ØA	B	C	Bianco / White			Marrone / Brown		
				€	Pz x conf Pcs/box- bag	Lotto min Min order	€	Pz x conf Pcs/box- bag	Lotto min Min order
11.27.102.33	11,5	8,5	13,5	-	5000	5000	-	5000	5000

## BLR

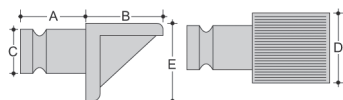

Blocchetto reggipiani in PP / Shelf support in PP

Codice Code	A	B	ØC	D	E	Bianco / White			Marrone / Brown		
						€	Pz x conf Pcs/box- bag	Lotto min Min order	€	Pz x conf Pcs/box- bag	Lotto min Min order
11.27.104.02	11,5	11,5	7	11,5	11,5	-	5000	5000	-	5000	5000

## BSR

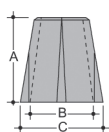

Bussola per reggipiani BLR in PP / T-nut for BLR in PP

Codice Code	A	ØB	ØC	Bianco / White			Marrone / Brown		
				€	Pz x conf Pcs/box- bag	Lotto min Min order	€	Pz x conf Pcs/box- bag	Lotto min Min order
11.27.103.02	11,5	7	9,7	-	5000	5000	-	5000	5000

## RA

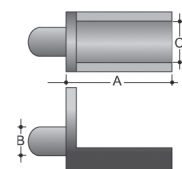

Reggiaste in PS antiurto / Shelf support in PS

Codice Code	A	ØB	ØC	Bianco / White			Marrone / Brown		
				€	Pz x conf Pcs/box- bag	Lotto min Min order	€	Pz x conf Pcs/box- bag	Lotto min Min order
11.27.105.03	20,5	7	10	-	5000	5000	-	5000	5000

Copritesta viti a testa cilindrica in PE (Con esagono incassato per vite 6MA)  
Screw cover in PE (With Hexagon for screw 6MA)

Codice Code	ØA	ØB	D	E	Nero/Black		
					€	Pz x conf Pcs/box-bag	Lotto min Min order
11.27.125.02	13	5,5	1,5	3,5	-	5000	5000

CVIE

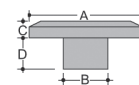

Rondelle sottoviti in HD e PE / HD and PE washers

Codice Code	Rondelle sottovite washers	ØA	ØB	C	Nero/Black			Bianco / White		
					€	Pz x conf Pcs/box-bag	Lotto min Min order	€	Pz x conf Pcs/box-bag	Lotto min Min order
11.27.147.02	HD	11	5,5	1,5	-	10000	10000	-	10000	10000
11.27.148.02	HD	11,5	3,2	1,2	-	10000	30000	-	10000	30000
11.27.149.02	HD	12	4,5	1,5	-	10000	10000	-	10000	10000
11.27.150.02	HD	14	6	1,5	-	10000	10000	-	10000	10000
11.27.151.02	HD	15	5	1,5	-	10000	10000	-	10000	20000
11.27.152.02	HD	16	6	1,5	-	5000	5000	-	5000	5000
11.27.153.02	HD	22	10	2,0	-	5000	5000	-	5000	10000
11.27.154.02	HD	24	8,5	2,0	-	5000	5000	-	5000	20000
11.27.155.02	PE	19	7	2	-	5000	5000	-	5000	30000

RS

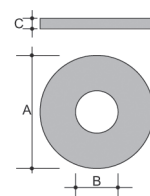

## BCM



### Blocchetto chiusura magnetica forza trazione Kg.4 Magnetic closure with traction force of 4 Kg

Codice Code	n <sup>^</sup> fori n <sup>^</sup> holes	A	B	C	D	E	Bianco / White			Marrone / Brown		
							€	Pz x conf Pcs/box- bag	Lotto min Min order	€	Pz x conf Pcs/box- bag	Lotto min Min order
21.27.174.00	1	47,5	30	16	13	-	-	250	1000	-	250	1000
21.27.175.00	2	47,5	30	16	13	30	-	100	1000	-	100	1000

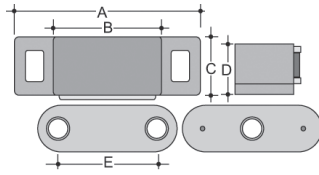

## FP



### Fermaportine in PS / Doorstops in PS

Codice Code	n <sup>^</sup> fori n <sup>^</sup> holes	n <sup>^</sup> chiodi n <sup>^</sup> nails	A	B	C	D	E	Bianco / White			Marrone / Brown		
								€	Pz x conf Pcs/box- bag	Lotto min Min order	€	Pz x conf Pcs/box- bag	Lotto min Min order
21.27.168.00	2	-	40	7,5	10,5	24	-	-	500	5000	-	500	5000
21.27.169.00	-	2	40	7,5	10,5	24	7	-	500	5000	-	500	5000

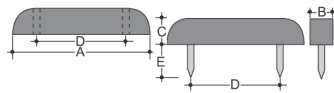

## MRT



### Mensola reggitubo armadio in PS / Holder shelf for wardrobe pipe in PS

Codice Code	A	B	C	Bianco / White			Marrone / Brown		
				€	Pz x conf Pcs/box- bag	Lotto min Min order	€	Pz x conf Pcs/box- bag	Lotto min Min order
21.27.162.00	55	40	21	-	250	5000	-	250	5000

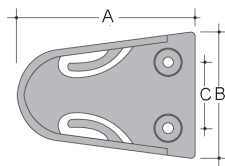

Mensola reggipiano a scatto per piani mm.15 in PS / Holder shelf in PS

Codice Code	A	ØB	C	D	Bianco / White			Marrone / Brown		
					€	Pz x conf Pcs/box- bag	Lotto min Min order	€	Pz x conf Pcs/box- bag	Lotto min Min order
21.27.165.00	34	10	8x14,5	8	-	1250	5000	-	1250	5000

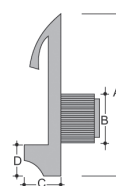

MRS



Piedino per gambe legno in PE / Glide in PE for wooden legs

Codice Code	A	B	C	ØD	E	Nero/Black		
						€	Pz x conf Pcs/box- bag	Lotto min Min order
11.27.120.02	46	20	32	10	4	-	3000	3000

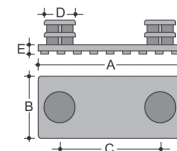

Piedino fisso per mobiletti / Fixed glide for cabinets

Codice Code	A	B	C	D	E	F	Nero/Black		
							€	Pz x conf Pcs/box- bag	Lotto min Min order
11.40.570.02	80	47	35	13	12	7	-	250	3000

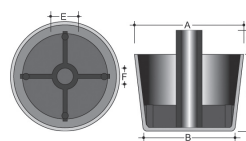

PFM



## 27 - MANIGLIE PER MOBILI / HANDLES FOR FURNITURE

### MOB

Maniglia ovale in PS antiurto nera (termoplastico) con buccola ottone filetto 4MA  
 Oval handle in PS (in thermosetting composition) with brass plated knobs thread 4MA

Codice Code	Resistenti al calore Heat-resistant handles	A	B	C	D	E	Nero/Black		
							€	Pz x conf Pcs/box-bag	Lotto min Min order
11.28.111.30	-	67	78	94	10	13	-	500	500

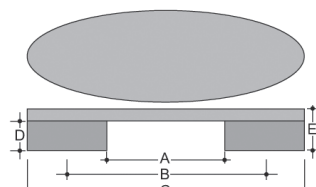

### MTT

Maniglia trapezoidale in PA (termoplastico) con buccola ottone filetto 4MA  
 Trapezoidal handle in PA (in thermosetting composition) with brass plated knobs thread 4MA

Codice Code	Resistenti al calore Heat-resistant handles	A	B	C	D	E	Nero/Black		
							€	Pz x conf Pcs/box-bag	Lotto min Min order
11.28.145.77	-	107	120	140	21	25	-	100	100

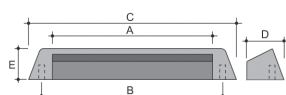

### MDA

Maniglia in ABS (termoplastico) con buccola ottone filetto 4MA  
 Handle in ABS (in thermosetting composition) with brass plated knobs thread 4MA

Codice Code	Resistenti al calore Heat-resistant handles	A	B	C	D	E	Nero/Black			Cromato / Chrome plated		
							€	Pz x conf Pcs/box-bag	Lotto min Min order	€	Pz x conf Pcs/box-bag	Lotto min Min order
21.28.113.00	-	60	73	90	15	26	-	100	2000	-	100	2000
21.28.114.00	-	86	100	120	15	26	-	100	2000	-	100	2000
21.28.115.00	-	116	130	152	15	26	-	100	2000	-	100	2000

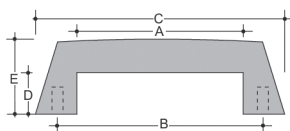

### MDB

Maniglia in ABS (termoplastico) con buccola ottone filetto 4MA  
 Handle in ABS (in thermosetting composition) with brass plated knobs thread 4MA

Codice Code	Resistenti al calore Heat-resistant handles	A	B	C	D	E	Nero/Black			Cromato / Chrome plated		
							€	Pz x conf Pcs/box-bag	Lotto min Min order	€	Pz x conf Pcs/box-bag	Lotto min Min order
21.28.117.00	-	80	90	100	22	30	-	100	2000	-	100	2000
21.28.118.00	-	97	108	118	26	33	-	100	2000	-	100	2000

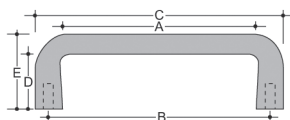

### Maniglia mobili curva in PP / Curved handle in PP

MMC

Codice Code	A	B	C	D	Nero/Black			Bianco ed altri colori/ White and other colors		
					€	Pz x conf Pcs/box- bag	Lotto min Min order	€	Pz x conf Pcs/box- bag	Lotto min Min order
11.28.159.02	52	64	87	23	-	1500	1500	-	1500	10500
11.28.170.02	88	96	123	28	-	1500	1500	-	1500	10500

Vite da utilizzare autofili.: TC UNI 9707 Ø 3,5  
Screin to use: TC UNI 9707 Ø 3,5

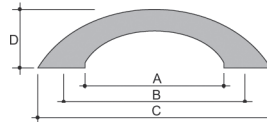

### Maniglia curva larga in PP / Wide curved handle in PP

MCL

Codice Code	A	B	C	D	E	F	Nero/Black			Bianco ed altri colori/ White and other colors		
							€	Pz x conf Pcs/box- bag	Lotto min Min order	€	Pz x conf Pcs/box- bag	Lotto min Min order
11.28.201.02	56	62	92	23	18	21	-	1000	3000	-	1000	10000

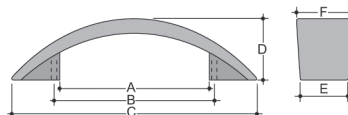

### Maniglia curva ellittica in PP / Curved elliptical handle in PP

MCE

Codice Code	A	B	C	D	Nero/Black			Bianco ed altri colori White and other colors		
					€	Pz x conf Pcs/box- bag	Lotto min Min order	€	Pz x conf Pcs/box- bag	Lotto min Min order
11.28.205.02	81	96	113	27	-	1000	5000	-	1000	10000

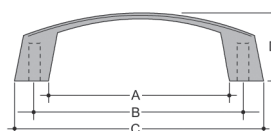

### Maniglia a filo in PP / Thread handle in PP

MF

Codice Code	A	B	C	Nero/Black			Bianco ed altri colori White and other colors		
				€	Pz x conf Pcs/box- bag	Lotto min Min order	€	Pz x conf Pcs/box- bag	Lotto min Min order
11.28.166.02	95	10	35	-	1500	3000	-	1500	10500



## RMF



### Rondelle per maniglia a filo in PP / Washers in PP for thread handle

Codice Code	A	B	C	D	Nero/Black			Bianco ed altri colori White and other colors		
					€	Pz x conf Pcs/box- bag	Lotto min Min order	€	Pz x conf Pcs/box- bag	Lotto min Min order
11.28.167.02	15	10	3,5	3,8	-	1500	9000	-	1500	10500

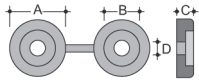

## MML



### Maniglia in PP / Handle in PP

Codice Code	A	B	C	D	E	Nero/Black			Colorato / Coloured		
						€	Pz x conf Pcs/box- bag	Lotto min Min order	€	Pz x conf Pcs/box- bag	Lotto min Min order
11.28.210.02	90	64	48	22	16	-	1000	1000	-	1000	5000

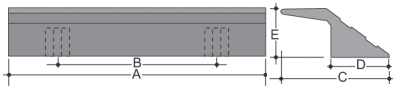

## 28 - MANIGLIE DA INCASSO / RECESS HANDLES

### Maniglia nera in PS antiurto / Shock proof handle in PS

MI

Codice Code	A	B	C	D	Nero/Black		
					€	Pz x conf Pcs/box- bag	Lotto min Min order
11.28.164.03	80x27	100	36	13	-	1000	1000

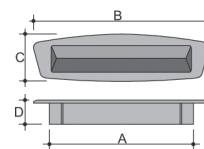

### Maniglia a scatto in PS antiurto (Per sportelli scorrevoli in metallo.) Flick handle, Shock proof in PS

MIS

Codice Code	A	B	C	D	Nero/Black			Colorato / Coloured		
					€	Pz x conf Pcs/box- bag	Lotto min Min order	€	Pz x conf Pcs/box- bag	Lotto min Min order
11.28.165.03	17x120	126	25	13	-	1000	1000	-	1000	3000

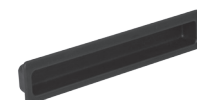
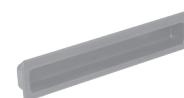
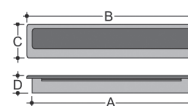

### Maniglia rotonda in PS antiurto interno liscio / Round handle, shock proof in PS

MIR

Codice Code	A	B	C	D	Nero/Black		
					€	Pz x conf Pcs/box- bag	Lotto min Min order
11.28.150.03	22	20	28	10	-	1500	6000
11.28.151.03	30	27	36	12	-	1000	1000
11.28.152.03	40	36	50	14	-	1000	1000

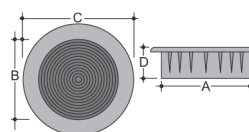

## BPV



Basi pomoli in ABS / Bases for knobs in ABS

Codice Code	A	B	C	D	Nero/Black			Cromato / Chromed plated		
					€	Pz x conf Pcs/box-bag	Lotto min Min order	€	Pz x conf Pcs/box-bag	Lotto min Min order
21.28.193.00	Ø50	5,5	8	Ø12	-	100	400	-	100	400

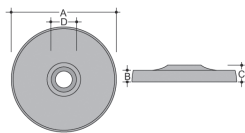

## POC



Pomello con testa incavata in ABS filettati 4MA  
Knob with sunken head in ABS thread 4MA

Codice Code	ØA	B	C	Nero/Black			Cromato / Chromed plated		
				€	Pz x conf Pcs/box-bag	Lotto min Min order	€	Pz x conf Pcs/box-bag	Lotto min Min order
21.28.171.00	24	18,0	8,0	-	500	500	-	500	500
21.28.172.00	30	19,0	11,5	-	250	500	-	250	500
21.28.173.00	40	20,0	18,0	-	200	400	-	200	400
21.28.174.00	50	21,5	24,0	-	100	200	-	100	200

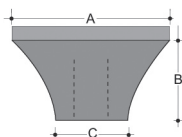

## PBC



Pomello con testa bombata in ABS filettati 4MA / Knob with convex head

Codice Code	ØA	B	C	D	Nero/Black			Cromato / Chromed plated		
					€	Pz x conf Pcs/box-bag	Lotto min Min order	€	Pz x conf Pcs/box-bag	Lotto min Min order
21.28.179.00	30	17.5	11.5	3.0	-	250	500	-	250	500
21.28.180.00	40	18.0	18.0	4.5	-	100	200	-	100	200
21.28.181.00	50	24.0	24.0	7.0	-	100	100	-	100	100

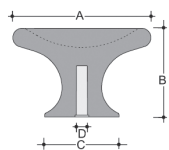

## POMC



Pomello concavo per mobili / Knob with concave head

Codice Code	ØA	B	C	D	Nero/Black		
					€	Pz x conf Pcs/box-bag	Lotto min Min order
11.28.220.02	40	25	21	3.2	-	500	500

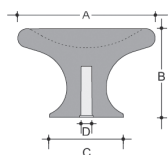

Pomoli sferici filettati in ABS / Threaded knobs in ABS

PFS

Codice Code	ØA	B	Nero/Black		
			€	Pz x conf Pcs/box- bag	Lotto min Min order
21.28.195.00	20	4MA	-	500	500
21.28.196.00	28	4MA	-	200	200
21.28.197.00	35	4MA	-	100	200

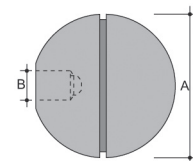

Pomello rotondo in PS / Round knobs in PS

POR

Codice Code	A	B	C	D	Nero/Black			Altri colori/ Other colors		
					€	Pz x conf Pcs/box- bag	Lotto min Min order	€	Pz x conf Pcs/box- bag	Lotto min Min order
11.28.184.03	Ø30	22	13	Ø10	-	500	500	-	500	5000

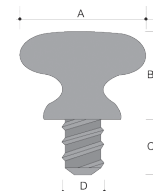

## 30 - VOLANTINI CON GAMBO - filetto MA / KNOBS WITH BOLTS- THREAD MA

### VGF

Volantino con gambo filettato in PS antiurto, 6-8 lobi con gambo in FE zincocromato  
*Star knobs with threaded bolt in PS shock proof.*

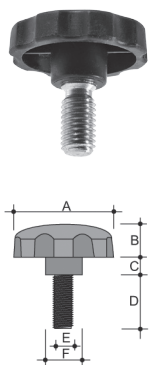

Codice Code	n° Lobi nr lobes	A	B	C	D	E	F	Nero/Black		
								€	Pz x conf Pcs/box-bag	Lotto min Min order
11.41.159.39	6	30	10	8	12	M6	13.5	-	500	1000
11.41.150.39	6	30	10	8	17	M6	13.5	-	500	1000
11.41.152.39	6	30	10	8	22	M6	13.5	-	500	1000
11.41.151.40	6	30	10	8	20	M8	13.5	-	500	1000
11.41.101.40	8	40	11	7	20	M8	16	-	250	1000
11.41.102.40	8	40	11	7	20	M10	16	-	250	1000
11.41.134.40	8	50	14	8,5	15	M8	18	-	150	10000
11.41.130.40	8	50	14	8,5	20	M10	18	-	150	450
11.41.139.40	8	50	14	8,5	25	M8	18	-	150	10000
11.41.132.40	8	50	14	8,5	25	M10	18	-	150	450
11.41.131.40	8	50	14	8,5	30	M10	18	-	150	450
11.41.220.40	8	60	15	9	20	M10	18	-	100	400
11.41.221.40	8	60	15	9	25	M10	18	-	100	1000
11.41.222.40	8	60	15	9	30	M10	18	-	100	1000

### VJB

Volantino Jolly basso in PP con gambo in FE zincocromato  
*Star knob in PP with zinc plated bolt*

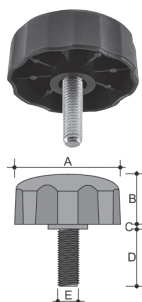

Codice Code	ØA	B	C	D	E	Nero/Black		
						€	Pz x conf Pcs/box-bag	Lotto min Min order
11.41.248.73	50	24	1,5	10	M8	-	500	500
11.41.246.73	50	24	1,5	15	M8	-	500	500
11.41.249.73	50	24	1,5	20	M8	-	500	500
11.41.250.73	50	24	1,5	25	M8	-	500	500
11.41.251.73	50	24	1,5	30	M8	-	500	500

### VJBB

Volantino Jolly basso in PP con battuta in FE e gambo in FE zincocromato  
*Star knob in PP with zinc plated bolt*

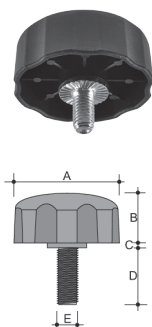

Codice Code	ØA	B	C	D	E	Nero/Black		
						€	Pz x conf Pcs/box-bag	Lotto min Min order
11.41.312.73	50	24	1,5	15	M8	-	500	5000

### VJA

Volantino Jolly alto in PP con gambo in FE zincocromato  
*Star knob in PP with zinc plated bolt*

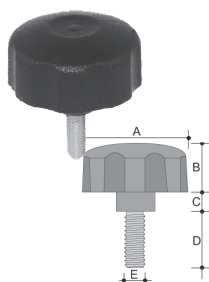

Codice Code	ØA	B	C	D	E	Nero/Black		
						€	Pz x conf Pcs/box-bag	Lotto min Min order
11.41.247.73	50	24	11,5	15	M8	-	500	500
11.41.241.73	50	24	11,5	25	M8	-	500	500

Volantino jolly alto in PP con battuta in FE e gambo in FE zincocromato  
*Star knob in PP with zinc plated bolt*

Codice Code	ØA	B	C	D	E	Nero/Black		
						€	Pz x conf Pcs/box-bag	Lotto min Min order
11.41.310.73	50	24	11,5	15	M8	-	500	500
11.41.311.73	50	24	11,5	25	M8	-	500	5000

VJAB

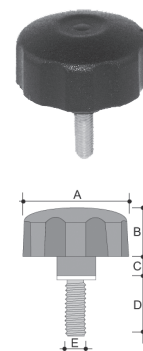

Volantino Jolly in PP con gambo in FE zincocromato  
*Star knob in PP with threaded zinc-plated bolt*

Codice Code	ØA	B	C	D	E	Nero/Black		
						€	Pz x conf Pcs/box-bag	Lotto min Min order
11.41.255.73	50	24	11,5	30	M8	-	500	500

VJS

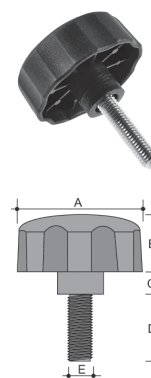

Volantino Jolly in PP con battuta in FE /*Star knob in PP with zinc plated bolt*

Codice Code	ØA	B	C	D	E	Nero/Black		
						€	Pz x conf Pcs/box-bag	Lotto min Min order
11.41.313.73	50	24	11,5	30	M8	-	500	500

VJSB

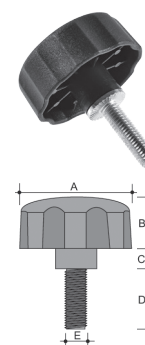

Volantini sottoplastra economici in PP con gambo in FE zincocromato  
*Star knob in PP with zinc plated bolt*

Codice Code	ØA	B	C	D	E	Nero/Black		
						€	Pz x conf Pcs/box-bag	Lotto min Min order
11.41.260.73	50	24	25,5	30	M8	-	500	500

VSE

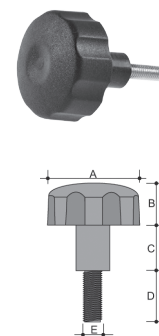

## VSEB

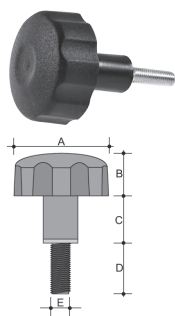

Volantini sottopiastra in PP con battuta in FE e gambo in FE zincocromato  
*Star knob in PP with zinc plated bolt*

Codice Code	ØA	B	C	D	E	Nero/Black		
						€	Pz x conf Pcs/box-bag	Lotto min Min order
11.41.262.73	50	24	30	30	M8	-	250	250

## VGJ

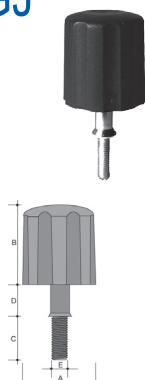

Volantino jolly in PP-gambo e battuta in FE zincocromato  
*Star knob in PP with zinc plated bolt*

Codice Code	ØA	B	C	D	E	Nero/Black		
						€	Pz x conf Pcs/box-bag	Lotto min Min order
11.41.245.73	50	54	30	23	M8	-	250	250

## VTB

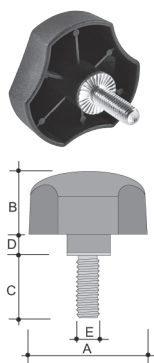

Volantino Twist in PP con gambo e battuta in FE zincocromato  
*Star knob in PP with zinc plated bolt*

Codice Code	ØA	B	C	D	E	Nero/Black		
						€	Pz x conf Pcs/box-bag	Lotto min Min order
11.41.320.73	55	25	25	9	M8	-	500	500

## V30

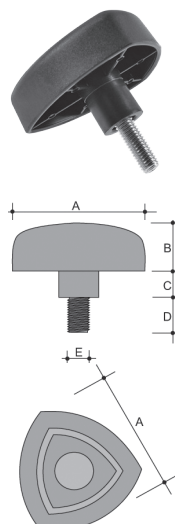

Volantino a 3 punte ovale in PP con gambo in FE zincocromato  
*Star knob in PP with zinc plated bolt*

Codice Code	ØA	B	C	D	E	Nero/Black		
						€	Pz x conf Pcs/box-bag	Lotto min Min order
11.41.289.73	63	22	18	15	M8	-	250	1000
11.41.290.73	63	22	12	30	M8	-	250	1000
11.41.292.73	63	22	18	32	M6	-	250	1000

Volantino con gambo filettato in PA-gambo in FE zincocromato rotondo zigrinato  
*Knurled knob in PA with zinc-plated bolt*

Codice Code	ØA	B	C	D	E	F	Nero/Black		
							€	Pz x conf Pcs/box-bag	Lotto min Min order
11.41.180.37	50	16	8	20	M10	18	-	450	450
11.41.181.37	50	16	8	25	M10	18	-	450	900
11.41.182.37	50	16	8	30	M10	18	-	450	450

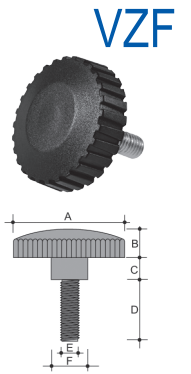

Volantino / Piede regol in PE nero con base esagonale e gambo in FE zincocromato  
*Adjustable knob/glide in PE with hexagonal base and zinc-plated bolt*

Codice Code	ØA	B	C	D	E	Nero/Black		
						€	Pz x conf Pcs/box-bag	Lotto min Min order
11.40.538.64	22	M8	20	11	6	-	1000	1000

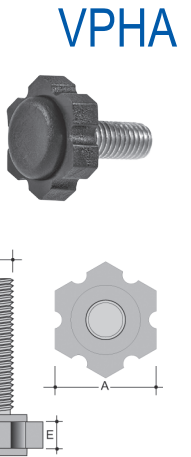

Volantino / Piedino regolabile / knob/ adjustable glide

Codice Code	ØA	B	C	D	Nero/Black		
					€	Pz x conf Pcs/box-bag	Lotto min Min order
11.41.330.73	30	13	20	M8	-	1000	1000
11.41.331.73	40	15	20	M8	-	500	3000
11.41.332.73	40	15	30	M10	-	500	1000
11.41.333.73	50	17	20	M8	-	500	1000
11.41.334.73	50	17	3	M10	-	500	1000

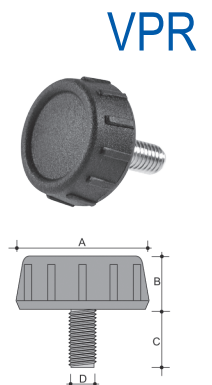

31-VOLANT CIECHI CON BUSSOLA-filet MA / BLIND KNOBS WITH BUSH-THREAD-MA

Volantino ciechi in PS antiurto con buccola in metallo filettata serie a 6-8 lobi  
*6-8 lobe star blind knob in PS with metal threaded bush*

Codice Code	n° Lobi nr lobes	A	B	C	D	E	F	Nero/Black		
								€	Pz x conf Pcs/box-bag	Lotto min Min order
11.41.160.30	6	30	10	8	M6	13,5	14	-	500	1000
11.41.161.30	6	30	10	8	M8	13,5	14	-	500	1000
11.41.104.30	8	40	12	6,5	M6	16	14	-	250	1250
11.41.105.30	8	40	12	6,5	M8	16	14	-	250	1250
11.41.109.30	8	40	12	15	M8	16	20	-	250	1000
11.41.140.30	8	50	14	9,5	M8	18	18	-	150	450
11.41.142.30	8	50	14	9,5	M10	18	16	-	150	450
11.41.210.30	8	60	15	9	M10	18	18	-	150	900
11.41.211.30	8	60	15	9	M8	18	18	-	150	900



## VJF

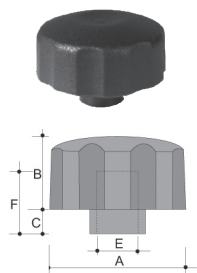

Volantino Jolly basso in PP con buccola in metallo filettata  
Star knob in PP with metal threaded bush

Codice Code	ØA	B	C	E x F	Nero/Black		
					€	Pz x conf Pcs/box-bag	Lotto min Min order
11.41.229.94	50	24	11,5	M6 x 25	-	500	500
11.41.230.94	50	24	11,5	M8 X 16	-	500	500
11.41.231.94	50	24	11,5	M10 X 16	-	500	500

## VZC

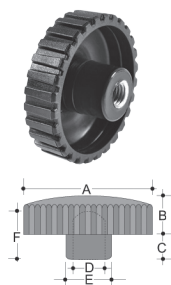

Volantino in PA con buccola in metallo filettata serie rotondo zigrinato  
Star knob in PA with metal threaded bush

Codice Code	ØA	B	C	D	E	F	Nero/Black		
							€	Pz x conf Pcs/box-bag	Lotto min Min order
11.41.190.77	50	14	9,5	M8	18	18	-	450	900
11.41.191.77	50	14	9,5	M10	18	16	-	450	900

## VFP

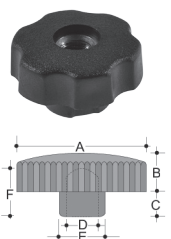

Volantino con foro passante in PS con buccola metallo serie 8 lodi  
Star knob in PS with metal threaded bush

Codice Code	A	B	C	D	E	F	Nero/Black		
							€	Pz x conf Pcs/box-bag	Lotto min Min order
11.41.269.30	30	10	8	M8	13,5	14	-	500	500

## 32 - DADI CON ALETTE - filetto MA / NUTS WITH TONGUES-thread MA

### DGA

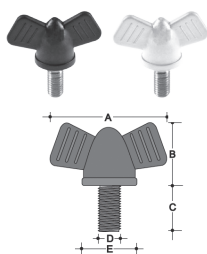

Dadi con alette in PS antiurto con gambo FE zincocromato  
Wing screws in PS with zinc-plated bolt

Codice Code	A	B	C	D	E	Nero/Black			Bianco / White		
						€	Pz x conf Pcs/box-bag	Lotto min Min order	€	Pz x conf Pcs/box-bag	Lotto min Min order
11.41.113.39	44	25	11	M6	20	-	500	5000	-	500	5000
11.41.110.39	44	25	15	M6	20	-	500	500	-	500	5000
11.41.111.40	44	25	20	M8	20	-	500	500	-	500	5000

### DCA

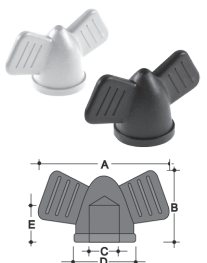

Dadi con alette in PS antiurto  
Wing screws in PS

Codice Code	ØA	B	C	D	E	Nero/Black			Bianco / White		
						€	Pz x conf Pcs/box-bag	Lotto min Min order	€	Pz x conf Pcs/box-bag	Lotto min Min order
11.41.114.30	44	25	M6	20	11	-	500	500	-	500	5000
11.41.115.30	44	25	M6	20	14	-	500	500	-	500	5000

Bussole filettate in FE / Iron T-nut

Codice Code	Filetto Thread	A	ØB	C	Fe-Iron		
					€	Pz x conf Pcs/box-bag	Lotto min Min order
11.40.210.67	5 x 0.80	17	6.2	8	-	10000	10000
11.40.211.67	6 x 1.00	19	8.0	10	-	7000	7000
11.40.212.67	8 x 1.25	22	9.5	11	-	4500	4500
21.40.213.00	10 x 1.50	25	12.0	11	-	3000	3000
11.40.215.67	1/4 W	19	8.0	10	-	7000	7000

B4G

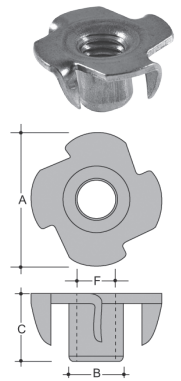

Buccola autofilettante a ragno in PA (Adatte per assemblaggio scocche)  
Spider T-nut in PA (Suited for the assembling of shells)

Codice Code	ØA	ØB	ØC	D	E	Nero/Black		
						€	Pz x conf Pcs/box-bag	Lotto min Min order
11.40.201.05	8	4	19	3	10	-	5000	10000

BAR

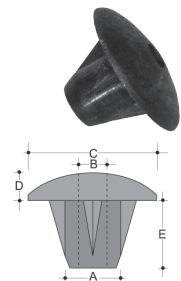

34 - PIEDI REGOLABILI / ADJUSTABLE FEET

Regol in FE con base in plastica-gambo e ghiera in FE zincocrom - filetto MA  
Non-tilt adjustable foot with plastic base and zinc-plated screw

Codice Code	ØA	B	C	D	Cromato / Chrome plated		
					€	Pz x conf Pcs/box-bag	Lotto min Min order
11.40.101.62	20	M6	13	7	-	1000	2000

PRA

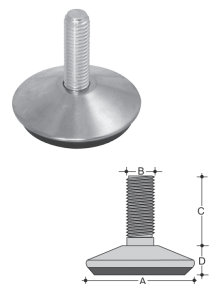

Regolabili in FE-base in plastica-gambo-ghiera in FE zincocrom con filetto  
Non-tilt adjustable foot with plastic base and zinc-plated screw

Codice Code	ØA	B	C	D	Cromato / Chrome plated		
					€	Pz x conf Pcs/box-bag	Lotto min Min order
11.40.102.62	25	M8	20	10,0	-	250	1000
11.40.103.62	30	M8	20	11,5	-	250	1000
11.40.104.62	35	M8	20	12,0	-	250	1000
11.40.105.62	40	M8	25	13,5	-	250	1000

PRB



## PRC



Regol.in FE-base in plast-gambo e ghiera in FE zincocromati con filetto  
*Non-tilt adjustable foot with plastic base and zinc-plated iron screw*

Codice Code	ØA	B	C	D	Cromato / Chrome plated		
					€	Pz x conf Pcs/box-bag	Lotto min Min order
11.40.110.62	25	M10	20	10,0	-	250	1000
11.40.111.62	30	M10	20	11,5	-	250	1000
11.40.112.62	35	M10	20	12,0	-	250	1000
11.40.113.62	40	M10	25	13,5	-	250	1000
11.40.114.62	50	M10	30	15,5	-	100	500

## PRD



Regolabili in FE-base in plast -gambo e ghiera in FE zincocrom con filetto  
*Non-tilt adjustable foot with plastic base and zinc-plated iron screw*

Codice Code	ØA	B	C	D	Cromato / Chrome plated		
					€	Pz x conf Pcs/box-bag	Lotto min Min order
11.40.120.62	50	M12	35	15,5	-	100	300

## RFR

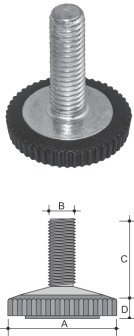

Regolabili in FE con base ricoperta in PE  
*Iron non-tilt adjustable foot with base covered in PE*

Codice Code	ØA	B	C	D	Nero/Black		
					€	Pz x conf Pcs/box-bag	Lotto min Min order
11.40.350.64	20	M6	20	6,5	-	2000	2000
11.40.351.64	28	M8	22	8	-	500	500
11.40.352.64	32	M10	25	9,5	-	500	500

## PREG

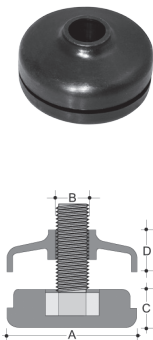

Piede regolabile in PP per vite in FE testa esagonale UNI 5739  
*Iron non-tilt adjustable foot for screws with hexagonal head UNI 5739*

Codice Code	ØA	ØB	C	D	Nero/Black		
					€	Pz x conf Pcs/box-bag	Lotto min Min order
11.40.232.97	40	10	6	13	-	500	500

Regolabili in FE- base in plastica, gambo e ghiera in FE zincocromo filetto MA  
*Non-tilt adjustable foot with plastic base and zinc-plated iron screw*

Codice Code	ØA	B	C	D	Nero/Black			Cromato / Chrome plated		
					€	Pz x conf Pcs/box-bag	Lotto min Min order	€	Pz x conf Pcs/box-bag	Lotto min Min order
11.40.582.63	30	M8	20	-	-	500	500	-	-	-
11.40.582.62	30	M8	20	-	-	-	-	-	500	500
11.40.584.63	40	M8	20	12	-	250	250	-	-	-
11.40.584.62	40	M8	20	12	-	-	-	-	250	250

## PBRB

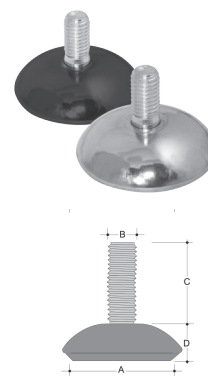

Regolabili in FE-base in plastica -gambo e ghiera in FE zincocrom filetto MA  
*Non-tilt adjustable foot with plastic base and zinc-plated iron screw*

Codice Code	ØA	B	C	D	Nero/Black			Cromato / Chrome plated		
					€	Pz x conf Pcs/box-bag	Lotto min Min order	€	Pz x conf Pcs/box-bag	Lotto min Min order
11.40.592.63	30	M10	20	-	-	500	2500	-	-	-
11.40.592.62	30	M10	20	-	-	-	-	-	500	2500
11.40.594.63	40	M10	20	12	-	250	2500	-	-	-
11.40.594.62	40	M10	20	12	-	-	-	-	250	2500
11.40.595.63	50	M10	20	13	-	100	1000	-	-	-
11.40.595.62	50	M10	20	13	-	-	-	-	100	100

## PBRC

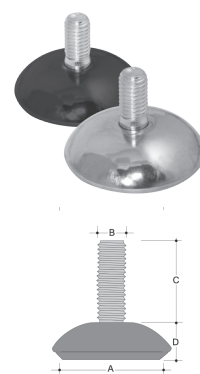

Regolabili in FE-base in plastica, gambo e ghiera in FE zincocrom filetto MA  
*Non-tilt adjustable foot with plastic base and zinc-plated iron screw*

Codice Code	ØA	B	C	D	Nero/Black			Cromato / Chrome plated		
					€	Pz x conf Pcs/box-bag	Lotto min Min order	€	Pz x conf Pcs/box-bag	Lotto min Min order
-	50	M12	-	-	-	-	-	-	-	-

## PBRD

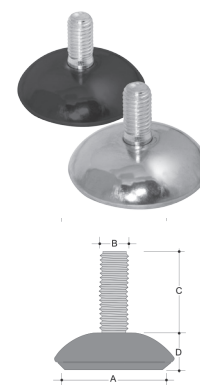

Regolabili con base in PE nero e gambo in FE zincocromato  
*Non-tilt adjustable foot with black PE base and zinc-plated iron screw*

Codice Code	ØA	B	C	D	Nero/Black		
					€	Pz x conf Pcs/box-bag	Lotto min Min order
11.40.150.63	30	M8	20	11.5	-	1000	1000
11.40.151.63	40	M8	25	14.5	-	500	500
11.40.152.63	30	M10	20	11.5	-	1000	1000
11.40.153.63	40	M10	25	14.5	-	500	500
11.40.154.64	50	M10	35	17.0	-	250	250
11.40.155.64	50	M12	35	17.0	-	250	250
11.40.310.64	60	M12	37	17.0	-	250	250
11.40.311.64	60	M10	37	17.0	-	250	250

## PRP

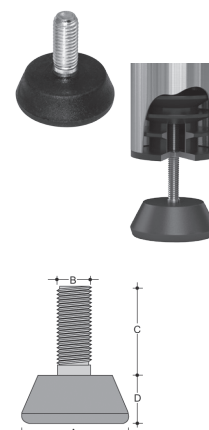

## PCR

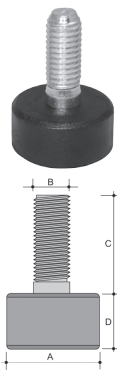

Regolabili cilindrici con base in PE nero e gambo in FE zincocromato  
*Non-tilt adjustable cylindrical foot with black PE base and zinc-plated iron screw*

Codice Code	ØA	B	C	D	Nero/Black		
					€	Pz x conf Pcs/box-bag	Lotto min Min order
11.40.160.63	23	M8	20	12	-	1000	1000
11.40.161.63	23	M10	20	12	-	1000	1000

## RBA

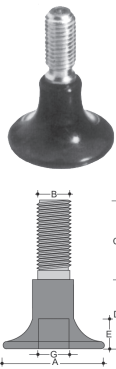

Piedi regol base alta in PA nero con impronta per chiave esagonale per avvitamento  
*Non-tilt adjustable foot with black PA base, for hexagonal screwing*

Codice Code	ØA	B	C	D	E	F	G	Nero/Black		
								€	Pz x conf Pcs/box-bag	Lotto min Min order
11.40.240.37	35	M10	25	24	11	14	10	-	5000	5000

## PRS



Piede regolabile stampato in PA / *Non-tilt adjustable foot in PA*

Codice Code	ØA	B	C	D	E	Nero/Black		
						€	Pz x conf Pcs/box-bag	Lotto min Min order
11.40.165.05	30	M10	20	5	10	-	1000	1000

## RPN

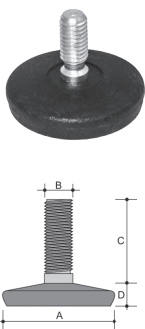

Piede regolabile piatto / *Non-tilt adjustable flat foot*

Codice Code	ØA	B	C	D	Nero/Black		
					€	Pz x conf Pcs/box-bag	Lotto min Min order
11.40.297.37	40	M8	20	10	-	500	500
11.40.298.37	40	M10	20	10	-	500	500

Piedino per gambe scrivania / Flat foot for desk

PGS

Codice Code	A	B	C	D	Nero/Black		
					€	Pz x conf Pcs/box-bag	Lotto min Min order
11.40.400.63	60	M8	35	7	-	500	500
11.40.401.63	60	M10	35	7	-	500	1000
11.40.221.63	80	M8	20	14	-	250	250
11.40.220.63	80	M10	20	14	-	250	250
11.40.380.63	100	M8	20	18	-	250	500
11.40.383.63	100	M8	25	18	-	250	250
11.40.381.63	100	M10	20	18	-	250	250
11.40.384.63	100	M10	25	18	-	125	500

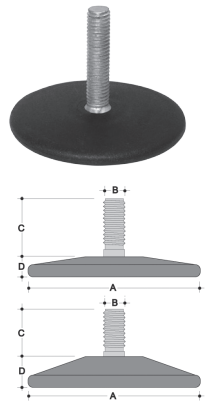

Piede piatto-Attacco sagomato Ø11-Dritto Ø 10-base in PA-gambo in FE zincocrom  
Flat foot in PA with zinc-plated Ø10-11

PASA

Codice Code	ØA	ØB	C	D	E	Nero/Black		
						€	Pz x conf Pcs/box-bag	Lotto min Min order
11.40.301.26	40	11	20	10	3,5	-	500	500
11.40.302.26	40	10	20	10	3,5	-	500	500

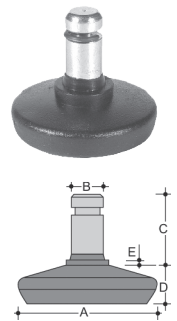

Regolabile in PE con pattino e ghiera in FE gambo cromato  
Non-tilt adjustable foot in PE with metal-covered plastic base

RPMG

Codice Code	ØA	B	C	D	Cromato / Chrome plated		
					€	Pz x conf Pcs/box-bag	Lotto min Min order
11.40.461.62	30	M8	25	16	-	500	1000
11.40.462.62	30	M10	25	16	-	500	1000

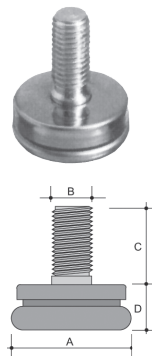

Regolabili con pattini in acciaio (Base in PA e gambo in FE zincocromato)  
Adjustable foot with steel skid (Base in PA and zinc-plated bolt)

RPM

Codice Code	ØA	B	C	D	Nero/Black		
					€	Pz x conf Pcs/box-bag	Lotto min Min order
11.40.171.62	30	M8	25	12.5	-	500	500
11.40.172.62	30	M10	25	12.5	-	500	500
11.40.174.62	40	M8	25	13.0	-	500	500
11.40.173.62	40	M10	25	13.0	-	500	500

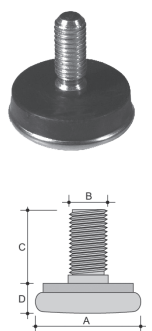

## PRG

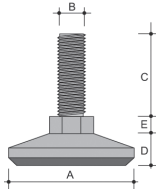

Piedi regol- vite gir a testa esag mm.17- gambo FE zincocrom (Base in PA nera e gambo in FE zincocrom)

*Non-tilt adjustable foot (base in PA and zinc-plated iron bolt)*

Codice Code	ØA	B	C	D	E	Nero/Black			Cromato / Chrome plated		
						€	Pz x conf Pcs/box-bag	Lotto min Min order	€	Pz x conf Pcs/box-bag	Lotto min Min order
11.40.399.34	28	M8	30	-	6,5	-	-	-	-	-	-
11.40.399.35	28	M8	30	-	6,5	-	-	-	-	-	-
11.40.234.34	40	M10	40	11,5	6,5	-	500	500	-	-	-
11.40.234.35	40	M10	40	11,5	6,5	-	-	-	-	500	500
11.40.235.34	40	M10	60	11,5	6,5	-	400	400	-	-	-
11.40.235.35	40	M10	60	11,5	6,5	-	-	-	-	400	400
11.40.236.34	50	M10	40	13,5	6,5	-	300	300	-	-	-
11.40.236.35	50	M10	40	13,5	6,5	-	-	-	-	300	300
11.40.237.34	50	M10	60	13,5	6,5	-	250	250	-	-	-
11.40.237.35	50	M10	60	13,5	6,5	-	-	-	-	250	250

## PGT

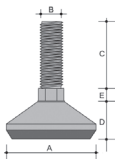

Piede regolabile con esagono e vite girevole (Base in PA nera o con ghiera cromata e gambo zincocromato)

*Non-tilt adjustable screw (base in PA or chromed base and zinc-plated iron bolt)*

Codice Code	ØA	B	C	D	E	Nero/Black			Cromato / Chrome plated		
						€	Pz x conf Pcs/box-bag	Lotto min Min order	€	Pz x conf Pcs/box-bag	Lotto min Min order
11.40.290.27	40	M10	25	11,5	6	-	500	500	-	-	-
11.40.290.28	40	M10	25	11,5	6	-	-	-	-	500	500
11.40.291.27	50	M10	30	13,0	6	-	300	300	-	-	-
11.40.291.28	50	M10	30	13,0	6	-	-	-	-	300	600
11.40.292.37	50	M12	35	13,0	6	-	250	1000	-	-	-
11.40.292.38	50	M12	35	13,0	6	-	-	-	-	250	1000

## PRGB

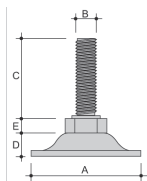

Piede regol. con vite girev. a testa esagonale mm.17 (Base e vite in FE zincocrom.)

*Adjust.foot with revolving screw and hexagonal head mm.17 (Base and screw in zinc-plated iron)*

Codice Code	ØA	B	C	D	E	Fe / Zinc-plated		
						€	Pz x conf Pcs/box-bag	Lotto min Min order
11.40.182.36	46	M10	40	7	6,5	-	400	400
11.40.184.36	46	M10	60	7	6,5	-	350	350

A richiesta si può variare filetto e lunghezza gambi.  
It is possible to change the thread and the length of bolts

## PRGC

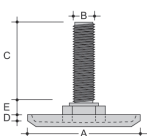

Piede regolabile con vite girevole a testa esagonale mm.17 (Base e vite FE zincocromate).

*Adjustable foot with revolving screw and hexagonal head mm.17- (Base and screw in zinc-plated)*

Codice Code	ØA	B	C	D	E	Fe / Zinc-plated		
						€	Pz x conf Pcs/box-bag	Lotto min Min order
11.40.420.36	50	M10	40	3	6,5	-	200	200
11.40.422.36	50	M10	60	3	6,5	-	200	1000

A richiesta si può variare filetto e lunghezza gambi.  
It is possible to change the thread and the length of bolts

Piede regolabile in PE nero con base esagonale e gambo in FE zincocromato  
Adjustable black foot in PE with hexagonal base and zinc-plated iron bolt

Codice Code	A	B	C	D	E	Nero/Black		
						€	Pz x conf Pcs/box- bag	Lotto min Min order
11.40.535.64	17	M6	14	10	5	-	1000	1000
11.40.538.64	22	M8	20	11	6	-	1000	1000

VPHA

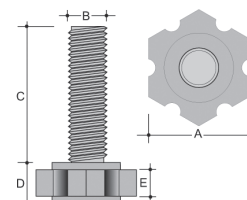

Volantino / Piedino regolabile / knob / adjustable foot

Codice Code	A	B	C	D	Nero/Black		
					€	Pz x conf Pcs/box- bag	Lotto min Min order
11.41.330.73	30	13	20	M8	-	1000	1000
11.41.331.73	40	15	20	M8	-	-	3000
11.41.332.73	40	15	30	M10	-	-	1000
11.41.333.73	50	17	20	M8	-	500	1000
11.41.334.73	50	17	30	M10	-	500	1000

VPR

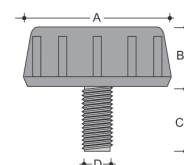

Piede regolabile in PE nero con base zigrinata - gambo in FE zincocromato  
Adjustable foot in PE with zinc-plated iron bolt

Codice Code	ØA	B	C	D	Nero/Black		
					€	Pz x conf Pcs/box- bag	Lotto min Min order
11.40.450.64	20	M6	17	5,5	-	2000	2000
11.40.479.64	25	M6	17	7	-	1000	1000
11.40.480.64	25	M8	25	7	-	1000	1000
11.40.485.64	25	M10	35	7	-	500	500
11.40.451.64	28	M8	25	6,5	-	500	500
11.40.452.64	28	M10	35	6,5	-	500	1000
11.40.453.64	32	M8	25	7	-	500	1000
11.40.454.64	32	M10	35	7	-	500	1000
11.40.500.64	35	M8	25	9	-	500	500
11.40.506.64	35	M10	25	9	-	500	500
11.40.507.64	35	M10	30	9	-	500	500
11.40.505.64	35	M10	35	9	-	500	500
11.40.508.64	35	M10	40	9	-	500	500
11.40.490.64	40	M10	35	9	-	500	500
11.40.515.64	50	M10	35	9,5	-	500	500
11.40.475.64	60	M10	35	10,5	-	500	500

PBZ

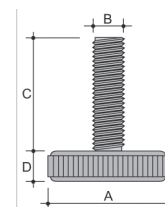

## VPH

Piede regolabile in PE nero con base esagonale e gambo in FE zincocromato  
Adjustable foot in PE with hexagonal base and zinc-plated iron bolt

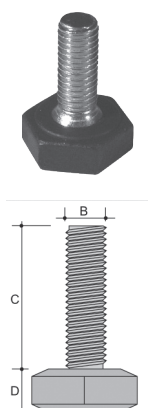

Codice Code	A	B	C	D	Nero/Black		
					€	Pz x conf Pcs/box-bag	Lotto min Min order
11.40.520.64	25	M8	25	8	-	1000	1000
11.40.523.64	25	M10	25	8	-	1000	1000
11.40.526.64	25	M8	35	8	-	1000	1000
11.40.529.64	25	M10	35	8	-	500	1000

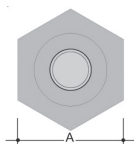

## PRBG

Piede regol-base grande e esagono mm 20 in PA con gambo in FE zincocromato  
Adjustable foot in PA with large base and hexagonal mm.20 - zinc-plated iron bolt



Codice Code	A	B	C	D	Nero/Black		
					€	Pz x conf Pcs/box-bag	Lotto min Min order
11.40.232.37	38	M8	25	15	-	500	500

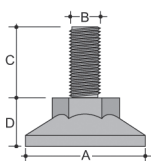

## PREP

Piede regol con base piccola e esagono mm 20 in PA - gambo in FE zincocromato  
Adjustable foot in PA with small base and hexagonal mm.20 and zinc-plated iron bolt



Codice Code	A	B	C	D	Nero/Black		
					€	Pz x conf Pcs/box-bag	Lotto min Min order
11.40.233.37	24	M8	23	14	-	500	500

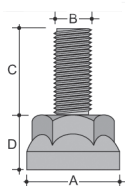

## PPML

Piedino per meccanismo letto/Adjustable foot for bed mechanism

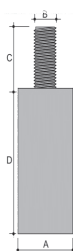

Codice Code	A	B	C	D	Nero/Black		
					€	Pz x conf Pcs/box-bag	Lotto min Min order
11.40.615.73	Ø25	M10	30	80	-	-	-

Im.pg.66

Piedino per mobili regolabile con base snodata (Piedino,dado e base snodata montati)  
Adjustable tilt glide for furniture-Adjustable foot,bolt and base are supplied assembled

PMU

Codice Code	A	B	C	D	E	Nero/Black		
						€	Pz x conf Pcs/box- bag	Lotto min Min order
11.40.562.73	12	28	Ø50	Ø10	Chiave 4	-	400	400

Piedino per mobili regolabile con base snodata (Piedino,dado e base snodata montati)  
Adjustable tilt glide for furniture-Adjustable foot,bolt and base are supplied assembled

PMU4

Codice Code	A	B	C	D	E	Nero/Black		
						€	Pz x conf Pcs/box- bag	Lotto min Min order
11.40.560.99	12	28	Ø50	Ø10	Chiave 4	-	125	1000

Piedino per mobili regol con base snodata- Piedino, dado, base snodata montati.  
Adjustable tilt glide for furniture - Adjustable foot, bolt and base supplied assembled

PMUC

Codice Code	A	B	C	D	E	Nero/Black			Grigio / Grey		
						€	Pz x conf Pcs/box- bag	Lotto min Min order	€	Pz x conf Pcs/box- bag	Lotto min Min order
21.40.563.00	12	17	Ø50	Ø10	Chiave 4-key 4	-	1000	1000	-	1000	5000
21.40.562.00	12	27	Ø50	Ø10	Chiave 4-key 4	-	500	1000	-	500	5000
21.40.564.00	-	44	Ø50	Ø10	Chiave 4-key 4	-	400	800	-	400	4000

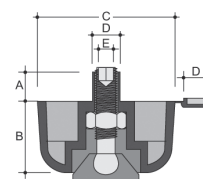

Piedino regolabile quadro con base ottagonale / Adjustable foot with octagonal base

IVC

Codice Code	materiale material	A	B	C	D	Nero/Black		
						€	Pz x conf Pcs/box- bag	Lotto min Min order
11.40.540.05	PA6	30x30	26	28	6	-	1500	1500
11.40.540.02	PP	30x30	26	28	6	-	1500	1500

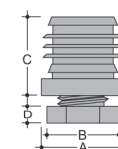

Piedino regolabile quadro con base rotonda con esagono  
Square adjustable foot with round base

IVC

Codice Code	A	B	C	D	E	Nero/Black		
						€	Pz x conf Pcs/box- bag	Lotto min Min order
11.40.541.02	30x30	30	21	28	12	-	1500	1500

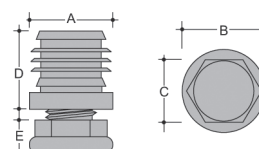

## IVR

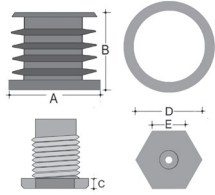

### Piede regolabile con base esagonale Adjustable foot with hexagonal base

Codice Code	ØA	B	C	D	E	Nero/Black		
						€	Pz x conf Pcs/box- bag	Lotto min Min order
11.40.545.02N	40	34	5	31	16	-	500	500

## PGSR

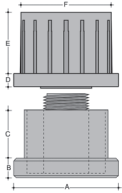

### Piede regolabile per gambe scrivania per tubo Ø 60 sp.1 mm Adjustable foot for desk for tube Ø 60 thickness 1 mm

Codice Code	A	S.T	B	C	D	E	F	Nero/Black		
								€	Pz x conf Pcs/box- bag	Lotto min Min order
11.40.390.02	64	1	12	30	8	38	58	-	200	200

## -

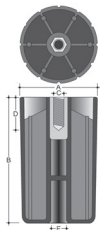

### Piede per base armadio in PPN / PPN cabinet foot for wardrobe

Codice Code	A	B	C	D	E	Nero/Black		
						€	Pz x conf Pcs/box- bag	Lotto min Min order
19.12.324.94	58	95	M8	28	Ø11	-	100	1000

## PFPA

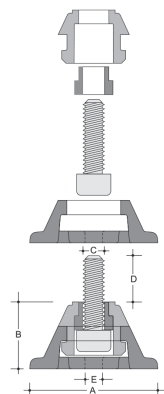

FORO PER FISSAGGIO AL PAVIMENTO  
FLOOR FIXING HOLE

### Piedino per fissaggio panca / Foot for bench fixing

Codice Code	A	B	C	D	E	Nero/Black		
						€	Pz x conf Pcs/box- bag	Lotto min Min order
11.30.613.99	60	31,5	M10	13	8,5	-	100	100

## 35-PIEDINI SNODATI - ORIENTABILI / ADJUSTABLE TILT GLIDES

Con base piana rigata in PE -ghiera in FE cromato e gambo in FE zinco cromato  
Adjustable tilt glide in PE and chromed zinc plated iron screw

PS

Codice Code	A	B	C	D	E	Cromato / Chrome plated		
						€	Pz x conf Pcs/box- bag	Lotto min Min order
11.40.135.62	25	M8	10	6	11	-	250	1000

Con base piana rigata / With plane striped base

PSC

Codice Code	A	B	C	D	E	Cromato / Chrome plated		
						€	Pz x conf Pcs/box- bag	Lotto min Min order
11.40.138.62	30	M8	10	6	13	-	250	500

Con base piana rigata / With plane striped base

PSD

Codice Code	A	B	C	D	E	Cromato / Chrome plated		
						€	Pz x conf Pcs/box- bag	Lotto min Min order
11.40.140.62	30	M10	12	6	13	-	250	500

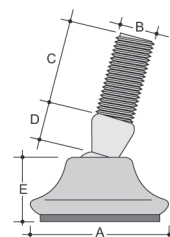

Con base bombata liscia in PE / Chromed foot with plastic base in PE

PSA

Codice Code	ØA	B	C	D	E	Cromato / Chrome plated		
						€	Pz x conf Pcs/box- bag	Lotto min Min order
11.40.136.62	25	M8	10	6	12	-	250	1000



Con base bombata ricoperta in FE cromato / Chromed foot with smooth base

PSB

Codice Code	ØA	B	C	D	E	Cromato / Chrome plated		
						€	Pz x conf Pcs/box- bag	Lotto min Min order
11.40.137.62	25	M8	10	6	13	-	250	1000

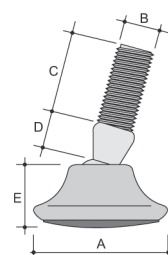

## PSE

### Piedi snodati con esagono 10 / Tilt glide with hexagon 10 mm

Codice Code	ØA	B	C	D	E	Cromato / Chrome plated		
						€	Pz x conf Pcs/box-bag	Lotto min Min order
11.40.246.62	35	M10	10	5	12	-	250	1000
11.40.247.62	35	M10	20	5	12	-	250	1000
11.40.248.62	35	M10	30	5	12	-	250	500

## PSG

### Piedi snodati con esagono 10 / Tilt glide with hexagon 10 mm

Codice Code	ØA	B	C	D	E	Cromato / Chrome plated		
						€	Pz x conf Pcs/box-bag	Lotto min Min order
11.40.206.62	50	M10	10	5	16	-	400	400
11.40.207.62	50	M10	20	5	16	-	350	350
11.40.208.62	50	M10	30	5	16	-	350	350

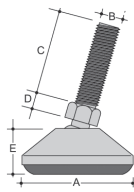

## PSF

### Con base piana in PP nero e gambo in FE zincocrom With plane black base in PP and zinc-plated iron bolt

Codice Code	ØA	B	C	D	E	Nero/Black		
						€	Pz x conf Pcs/box-bag	Lotto min Min order
11.40.128.37	26	M8	10	6	11,5	-	1000	1000

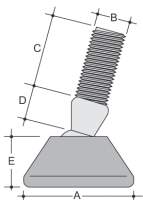

## PSH

### Base in PP nero gambo con esagono 10 / Black base in PP with hexagon 10 mm

Codice Code	ØA	B	C	D	E	Nero/Black		
						€	Pz x conf Pcs/box-bag	Lotto min Min order
11.40.129.37	26	M10	10	5	11,5	-	500	1000
11.40.130.37	26	M10	20	5	11,5	-	500	500
11.40.131.37	26	M10	30	5	11,5	-	500	500

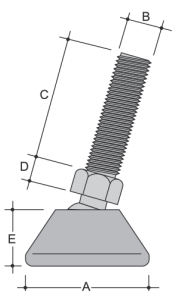

Piedi snodati e base in PE piana rigata rivestita in FE cromato  
Tilt glide and chrome plated plane-striped base in PE

PSE4

Codice Code	ØA	B	C	D	Cromato / Chrome plated		
					€	Pz x conf Pcs/box- bag	Lotto min Min order
11.40.337.62	25	6,5	30	11	-	250	1000

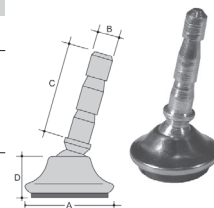

Con base bombata rivestita in FE cromato/Tilt glide with chromed convex base in Fe

PSE5

Codice Code	ØA	B	C	D	Cromato / Chrome plated		
					€	Pz x conf Pcs/box- bag	Lotto min Min order
11.40.339.62	25	6,5	30	13	-	250	1000

Con base bombata rivestita in FE cromato/Tilt glide with chromed convex base in Fe

PSE8

Codice Code	ØA	B	C	D	Cromato / Chrome plated		
					€	Pz x conf Pcs/box- bag	Lotto min Min order
11.40.338.62	25	6,5	30	12	-	250	1000



Piedi snodati con base piana / Tilt glides with plane base

PSE9

Codice Code	ØA	B	C	D	Nero/Black			Neutro/Neutral			Cromato/ Chromed plated			
					€	Pz x conf Pcs/box- bag	Lotto min Min order	€	Pz x conf Pcs/box- bag	Lotto min Min order	€	Pz x conf Pcs/box- bag	Lotto min Min order	
11.40.340.37N	25	6,5	30	12	-	1000	1000	-	-	-	-	-	-	-
11.40.342.73U	25	6,5	30	12	-	-	-	-	1000	1000	-	-	-	-
11.40.340.73C	25	6,5	30	12	-	-	-	-	-	-	-	1000	10000	-



Piedi snodati con base piana in PP neutra pattino in feltro  
Tilt glides with plane neutral PP base and felt skid

PSE9F

Codice Code	ØA	B	C	D	Nero/Black			Neutro/neutral		
					€	Pz x conf Pcs/box- bag	Lotto min Min order	€	Pz x conf Pcs/box- bag	Lotto min Min order
11.40.344.79	25	6,5	30	12	-	1000	1000	-	1000	1000



Espansori in PE per PSE 4-5-8-9  
Insert for PSE 4-5-8-9

ES

Codice Code	ØA	B	C	D	Nero/Black			Neutro/neutral		
					€	Pz x conf Pcs/box- bag	Lotto min Min order	€	Pz x conf Pcs/box- bag	Lotto min Min order
11.40.334.02	14	10	23	5	-	2000	2000	-	2000	10000
11.40.335.02	17	13	24	5,5	-	1000	1000	-	1000	10000
11.40.336.02	18	14	24	5,5	-	1000	1000	-	1000	10000

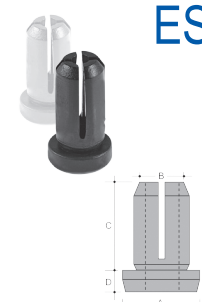

## PSEP

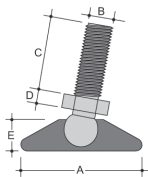

Piedi snodati - base piana in PA nera gambo esagono mm 10 in FE zincocromato  
Tilt glide with plane base in PA and zinc-plated iron bolt hexagon 10 mm

Codice Code	ØA	B	C	D	E	Nero/Black		
						€	Pz x conf Pcs/box-bag	Lotto min Min order
11.40.341.37	38	M8	30	4	10	-	500	500

## PGSI

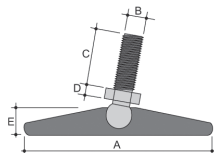
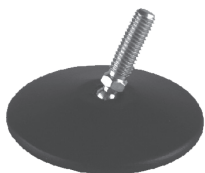

Piedi snodati - base piana in PA nera gambo esagono mm 10 in FE zincocromato  
Tilt glide with plane base in PA and zinc-plated iron bolt hexagon 10 mm

Codice Code	A	ØB	C	D	E	Nero/Black		
						€	Pz x conf Pcs/box-bag	Lotto min Min order
11-40-601-73	80	M10	20	4	15	-	250	250
11-40-602-73	80	M10	30	4	15	-	250	250
11-40-611-73	100	M10	20	4	21	-	125	1000
11-40-612-73	100	M10	30	4	21	-	125	250

## PSGA

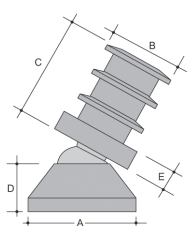

Piedi snodati con base e gambo alettato in PP  
Tilt glide with base and ribbed stem in PP

Codice Code		ØA	B	C	D	E	Nero/Black		
							€	Pz x conf Pcs/box-bag	Lotto min Min order
11.40.315.02	non montato not assembled	25	20x1,5	23,5	11,5	5	-	1000	1000
11.40.316.02	montato assembled	25	20x1,5	23,5	11,5	5	-	500	3000

## PSRS

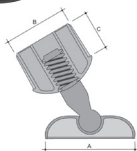

Regol snodato Ø80 per scrivania con gambo esagono CH 17 per tubo Ø50 sp.1,5  
Adjust. tilt glide Ø80 for desk with hexagon thread CH17 for tube Ø50 thickness 1,5

Codice Code	ØA	B	C	Nero/Black			Grigio Grey (pantone 429C)		
				€	Pz x conf Pcs/box-bag	Lotto min Min order	€	Pz x conf Pcs/box-bag	Lotto min Min order
11.40.209.92	80	47	38	-	100	500	-	100	2000

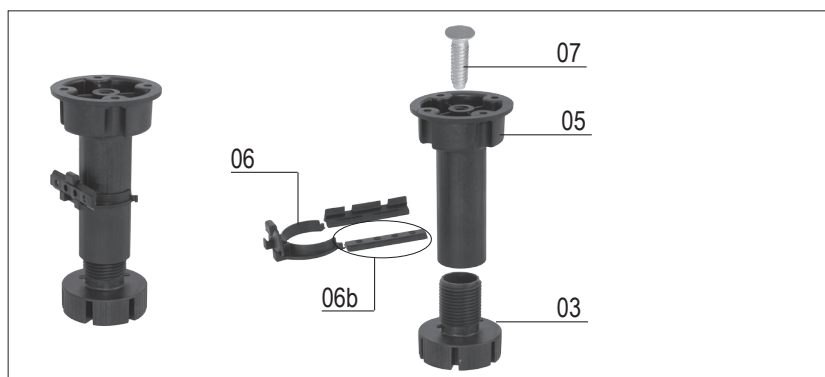
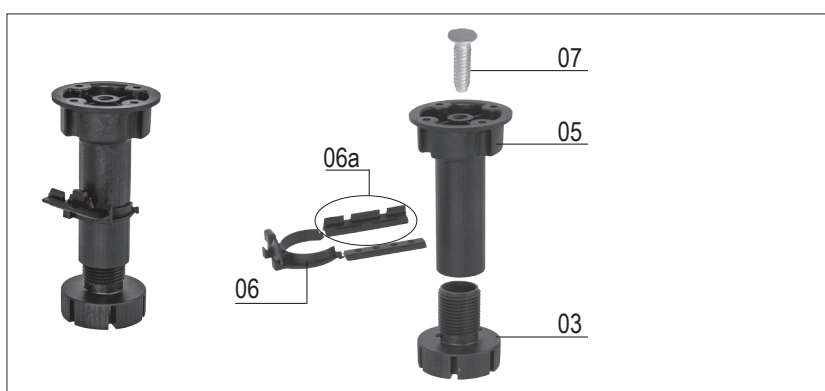
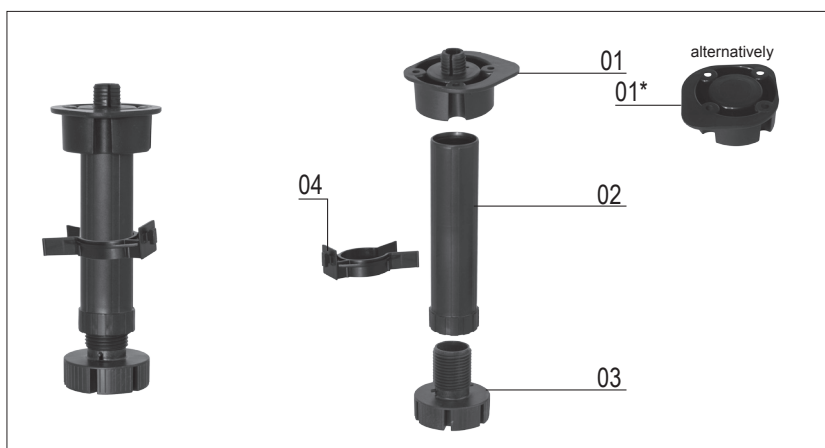

01	SGC	Sottomobile per gamba per cucine (CON PERNO) <i>Foot insert for kitchen leg (With spreading down)</i>	pg.128
01*	SGC	Sottomobile per gamba per cucine (SENZA PERNO) <i>Foot insert for kitchen leg (Without spreading down)</i>	pg.128
02	PFGC	Prolunga per gamba cucine / <i>Extension for kitchen leg</i>	pg.128
03	PTGC	Piedino a terra filettato per gambe cucina / <i>Threaded glide for kitchen leg</i>	pg.128
04	GZCI	Gancio per zoccolo cucine con imbocco / <i>Clip for kitchen leg with entrance</i>	pg.129
05	PSGC	Piedino sottomobile con gamba per cucine / <i>Foot insert for kitchen leg</i>	pg.129
06	GZC	Gancio per zoccolo cucine / <i>Clip for kitchen base</i>	pg.128
07	-	Gambo filettato per piedino cucine / <i>Threaded stem for kitchen foot</i>	pg.129

	alternatively
01 (or 01*)+02	05
03	
06 + (a or b)	04

## PTGC



Im.pg.127

### Piedino a terra filettato per gambe cucina / Threaded glide for kitchen leg

Codice Code	A	B	C	Nero/Black		
				€	Pz x conf Pcs/box-bag	Lotto min Min order
11.40.569.03	49	18	32	-	-	-

## PFGC

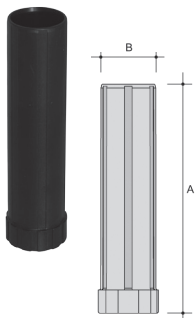

Im.pg.127

### Prolunga per gamba cucina / Extension for kitchen leg

Codice Code	A	B	Nero/Black		
			€	Pz x conf Pcs/box-bag	Lotto min Min order
11.40.577.03	75	30	-	-	-
11.40.578.03	92	30	-	-	-
11.40.579.03	123	30	-	-	-

## GZC



Im.pg.127

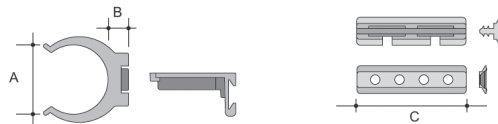

### Gancio per zoccolo cucina / Clip for kitchen base

Codice Code	A	B	C	Nero/Black		
				€	Pz x conf Pcs/box-bag	Lotto min Min order
11.40.574.02	30	8	4,5	-	-	-

## SGC

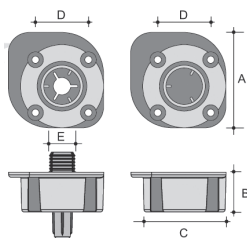

### Sottomobile per gambo cucina / Foot insert for kitchen leg

Codice Code	Con perno With spreading down	A	B	C	D	E	Nero/Black		
							€	Pz x conf Pcs/box-bag	Lotto min Min order
11.40.575.02	V	58	24	49	32	16	-	-	-
11.40.576.02	-	58	24	49	32	-	-	-	-

Im.pg.127

Piedino sottomobile con gamba per cucine / Foot insert for kitchen leg

PSGC

Codice Code	A	B	C	D	Nero/Black		
					€	Pz x conf Pcs/box- bag	Lotto min Min order
11.40.565.03	77	30	M10X2	46	-	500	-
11.40.566.03	97	30	M10X2	46	-	500	-
11.40.567.03	127	30	M10X2	46	-	200	-

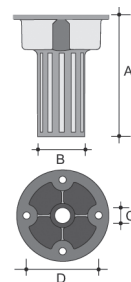

Im.pg.127

Gancio per zoccolo cucine con imbocco / Clip for kitchen leg with entrance

GZCI

Codice Code	A	B	Nero/Black		
			€	Pz x conf Pcs/box- bag	Lotto min Min order
11.40.568.02	30	9	-	100	-

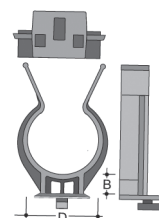

Im.pg.127

Gambo filettato per piedino cucine / Threaded stem for kitchen foot

Codice Code	A	B	Zinco-cromato/ Zinc plated		
			€	Pz x conf Pcs/box- bag	Lotto min Min order
8.01.036.206	M10X2	34	-	-	-



Im.pg.127



## PGAM



Pompa a gas per ante mobili / Gas lift for wardrobe doors

Codice Code	A	B	C	D	E	Newton (N)	Acciaio INOX / Steel		
							€	Pz x conf Pcs/box-bag	Lotto min Min order
21.30.383.00	250	88	32	Ø15	6	60	-	100	100
21.30.380.00	250	88	32	Ø15	6	80	-	100	100
21.30.381.00	250	88	32	Ø15	6	100	-	100	100
21.30.382.00	250	88	32	Ø15	6	120	-	100	100

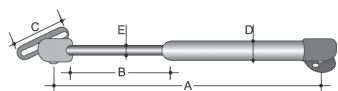

(R) Richiedere preventivo / Ask for a quotation

## PDBT



Piedino da avvitare a base triangolare / Triangular foot

Codice Code	A	B	C	E	H	L x l	Nero/Black		
							€	Pz x conf Pcs/box-bag	Lotto min Min order
21.29.125.00	5,8	20	16	64	45	130x130	-	1250	1250

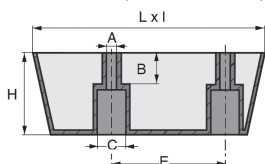

## PPDA



Piedino per divano in acciaio inox / Stainless steel foot for sofa

Codice Code	A	B	C	D	E	Ø	Acciaio INOX / Steel		
							€	Pz x conf Pcs/box-bag	Lotto min Min order
21.29.120.00	190	17	91	27	71	6	-	-	-

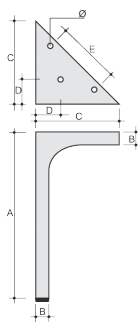

Agganci e distanziale per sedia a pozzetto / Links and spacer for armchair

ADP

Codice Code	A	B	C	D	E	F	G	H	I	L	M	N	Nero/Black		
													€	Pz x conf Pcs/box- bag	Lotto min Min order
11.22.150.05	50	42	25	Ø5	9	55	52	32	12	Ø20	Ø8	6	-	200	1000

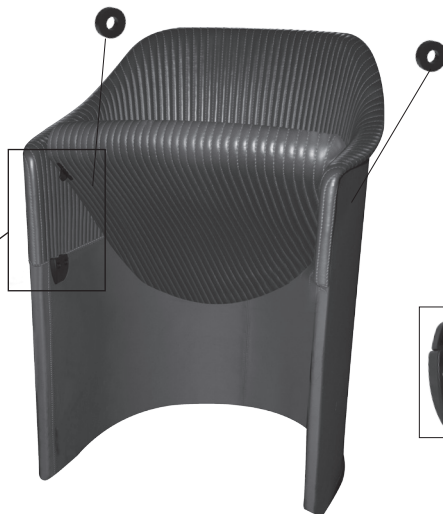
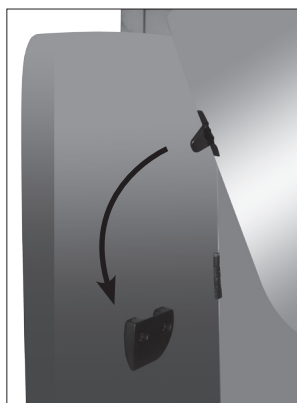
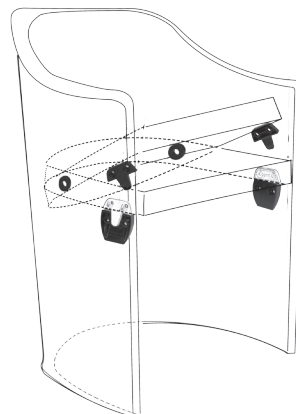
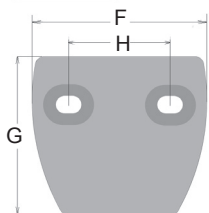
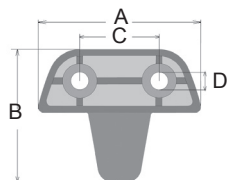

## 38 - PIEDINI BASI GIREVOLI / GLIDES FOR CHAIRS AND FURNITURE

### BHI

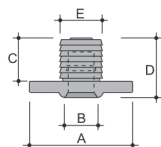

Codice Code	A	B	C	D	E	Nero/Black		
						€	Pz x conf Pcs/box-bag	Lotto min Min order
11.25.331.05	30	Ø8	13	16,5	12,3	-	5000	5000

### GLIS

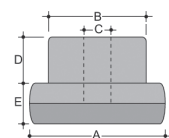

Codice Code	GAMBO MONTATO PIN ASSEMBLED Ø10-11	Da Utilizzare con gambi filettati e piastre To use with threaded pin and iron plate	A	B	C	D	E	Nero/Black		
								€	Pz x conf Pcs/box-bag	Lotto min Min order
11.25.255.92	V	-	50	36	10	17	15	-	400	400
11.25.256.92	-	V	50	36	8	17	15	-	400	2000

### GLISC

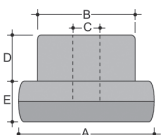

Codice Code	GAMBO MONTATO PIN ASSEMBLED Ø10-11	A	B	C	D	E	Nero/Black		
							€	Pz x conf Pcs/box-bag	Lotto min Min order
11.25.239.92	V		36	10	17	15	-	400	400

### GLIC

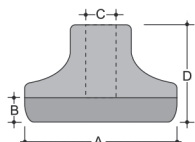

Codice Code	GAMBO MONTATO PIN ASSEMBLED gambo Ø10-11 pin Ø10-11	Da Utilizzare con gambi filettati e piastre To use with threaded pin and iron plate	A	B	C	D	Nero/Black		
							€	Pz x conf Pcs/box-bag	Lotto min Min order
11.25.234.92	V	-	50	13	10	32	-	500	500
11.25.235.92 *	-	V	50	13	8	32	-	500	1000

\* Con base in PA e coperchio in PP - c= perni come ruote  
\* With base in PA and cover in PP

A RICHIESTA / ON REQUEST

Senza gambo montato lotto minimo 1000 pezzi  
Minimum order 1000 pcs with disassembled pin

Basi girevoli a campana per sedie e mobili  
Revolving glide for chairs and furniture

GLICC

Codice Code	GAMBO MONTATO PIN ASSEMBLED gambo Ø10-11 pin Ø10-11	Da Utilizzare con gambi filettati e piastre To use with threaded pin and iron plate	A	B	C	D	Nero/Black		
							€	Pz x conf Pcs/box- bag	Lotto min Min order
11.25.236.92	V	-	50	13	10	32	-	500	500

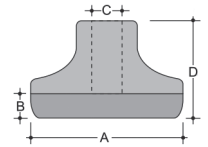

Basi girevoli ovali per sedie e mobili / Revolving glide for chairs and furniture

GLIO

Codice Code	GAMBO MONTATO PIN ASSEMBLED gambo Ø11 pin Ø11	Da Utilizzare con gambi filettati e piastre To use with threaded pin and iron plate	A	B	C	Nero/Black		
						€	Pz x conf Pcs/box- bag	Lotto min Min order
11.25.237.92	V	-	65	40	10	-	200	200
11.25.238.92 *	-	V	65	40	8	-	200	1000

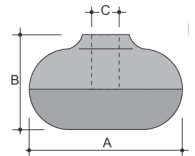

\* Con base in PA e coperchio in PP - c= perni come ruote  
\* With base in PA and cover in PP

A RICHIESTA / ON REQUEST

Senza gambo montato lotto minimo 1000 pezzi  
Minimum order 1000 pcs with disassembled pin

Con gambo GPB Ø 10 montato lotto minimo 3000 pezzi  
Minimum order 3000 pcs with GPB Ø 10 pin assembled.

Basi girevoli ovali per sedie e mobili / Revolving glide for chairs and furniture

GLIA

Codice Code	GAMBO MONTATO PIN ASSEMBLED gambo Ø11 pin Ø11	A	B	C	Nero/Black		
					€	Pz x conf Pcs/box- bag	Lotto min Min order
11.25.258.05	V	50	69	10	-	250	250

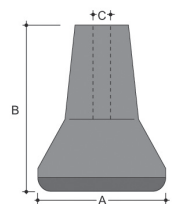

\* Con base in PA e coperchio in PP - c= perni come ruote  
\* With base in PA and cover in PP

A RICHIESTA / ON REQUEST

Senza gambo montato lotto minimo 1000 pezzi  
Minimum order 1000 pcs with disassembled pin

Basi girevoli ovali per sedie e mobili / Revolving glides for chairs and furniture

GLIT

Codice Code	GAMBO MONTATO PIN ASSEMBLED gambo Ø11 pin Ø11	Da Utilizzare con gambi filettati e piastre To use with threaded pin and iron plate	A	B	C	Nero/Black		
						€	Pz x conf Pcs/box- bag	Lotto min Min order
11.25.230.02	V	-	Ø35	35	10	-	500	1000
11.25.231.02 *	-	V	Ø35	35	8	-	500	500

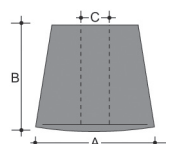

A RICHIESTA / ON REQUEST

Senza gambo montato lotto minimo 1000 pezzi  
Minimum order 1000 pcs with disassembled pin

## GLIP

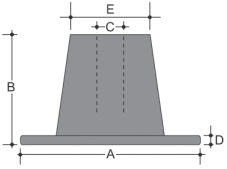

### Basi girevoli per sedie e mobili / Revolving glide for chairs and furniture

Codice Code	GAMBO MONTATO PIN ASSEMBLED gambo Ø11 pin Ø11	Da Utilizzare con gambi filettati e piastre To use with threa- ded pin and iron plate	A	B	C	D	E	Nero/Black		
								€	Pz x conf Pcs/box- bag	Lotto min Min order
11.25.229.05	V	-	Ø50	33	10	5	Ø23	-	250	1000
11.25.228.05	-	V	Ø50	33	8	5	Ø23	-	500	1000

## GLICI

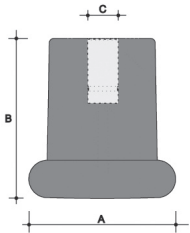

### Basi girevoli ovali per sedie e mobili / Oval revolving glides for chairs and furniture

Codice Code	GAMBO MONTATO PIN ASSEMBLED gambo Ø10-11 pin Ø10-11	A	B	C	Nero/Black		
					€	Pz x conf Pcs/box- bag	Lotto min Min order
11.25.227.05	V	Ø50	53	10	-	250	250

## 39 - DOPPIE RUOTE PIVOTANTI Ø 65 / TWIN CASTORS Ø 65

### Doppia ruota Ø 65 / Twin-castors Ø 65

DRH

Codice Code	GAMBO MONTATO PIN ASSEMBLED gambo Ø11 pin Ø11	Da Utilizzare con gambi filettati e piastre To use with threaded pin and iron plate	A	B	C	D	E	F	Nero/Black		
									€	Pz x conf Pcs/box-bag	Lotto min Min order
11.25.250.23.N3	V	-	Ø65	68	54	Ø10	45	22	-	200	200
11.25.355.23.N	-	V	Ø65	68	54	Ø8	45	22	-	200	200

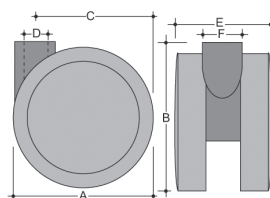

### Doppia ruota Ø 65 autofrenante / Twin-castors Ø 65 self-braking

DRHA

Codice Code	GAMBO MONTATO PIN ASSEMBLED gambo Ø11 pin Ø11	Da Utilizzare con gambi filettati e piastre To use with threaded pin and iron plate	A	B	C	D	E	F	Nero/Black		
									€	Pz x conf Pcs/box-bag	Lotto min Min order
11.25.251.83.N3	V	-	Ø65	68	54	Ø10	45	22	-	200	200
11.25.356.83.N	-	V	Ø65	68	54	Ø8	45	22	-	200	1000

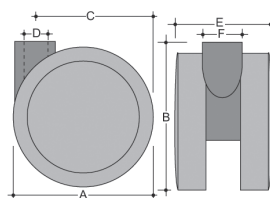

### Doppia ruota Ø 65 (ricoperta in TPU) / Twin-castor Ø 65 (covered with TPU)

DRHD

Codice Code	GAMBO MONTATO PIN ASSEMBLED gambo Ø11 pin Ø11	Da Utilizzare con gambi filettati e piastre To use with threaded pin and iron plate	A	B	C	D	E	F	Nero/Black		
									€	Pz x conf Pcs/box-bag	Lotto min Min order
11.25.252.55.N3	V	-	Ø65	68	54	Ø10	45	22	-	200	200
11.25.359.55.N	-	V	Ø65	68	54	Ø8	45	22	-	200	200

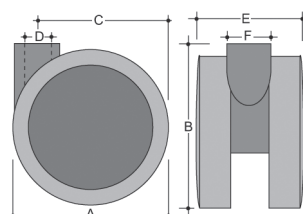

## DRHAD

Doppia ruota Ø 65 autofrenante (ricoperta in PUR)  
Twin-caster Ø 65 self-braking (covered with PUR)

Codice Code	GAMBO MONTATO PIN ASSEMBLED gambo Ø11 pin Ø11	Da Utilizzare con gambi filettati e piastre To use with threaded pin and iron plate	A	B	C	D	E	F	Nero/Black		
									€	Pz x conf Pcs/box-bag	Lotto min Min order
11.25.253.56.N3	V	-	Ø65	68	54	Ø10	45	22	-	200	200
11.25.358.56.N	-	V	Ø65	68	54	Ø8	45	22	-	200	1000

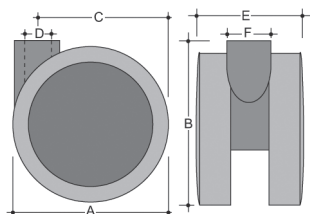

## DRHB

Doppia ruota Ø 65 con freno / Twin-caster Ø 65 with brake

Codice Code	GAMBO MONTATO PIN ASSEMBLED gambo Ø11 pin Ø11	Da Utilizzare con gambi filettati e piastre To use with threaded pin and iron plate	A	B	C	D	E	F	Nero/Black		
									€	Pz x conf Pcs/box-bag	Lotto min Min order
11.25.350.23.N3	V	-	Ø65	68	54	Ø10	45	22	-	200	1000
11.25.349.23.N	-	V	Ø65	68	54	Ø8	45	22	-	200	200

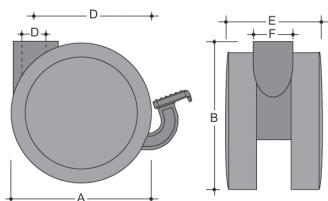

## DRHC

Doppia ruota Ø 65 - Cromata / Chromed twin-caster Ø 65 -

Codice Code	GAMBO MONTATO PIN ASSEMBLED gambo Ø11 pin Ø11	A	B	C	D	E	F	Nero/Black		
								€	Pz x conf Pcs/box-bag	Lotto min Min order
11.25.382.23.C3	V	Ø65	68	54	Ø10	45	22	-	150	600

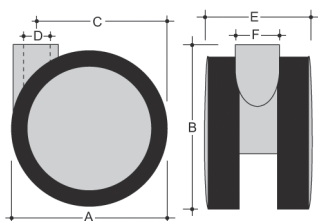

Doppia ruota Ø65 (ricop in TPU)-Crom-Chromed twin-castor Ø65 (covered with TPU)

DRHDC

Codice Code	GAMBO MONTATO PIN ASSEMBLED gambo Ø11 pin Ø11	A	B	C	D	E	F	Cromato / Chrome plated		
								€	Pz x conf Pcs/box-bag	Lotto min Min order
11.25.387.55.C3	V	Ø65	68	54	Ø10	45	22	-	150	600

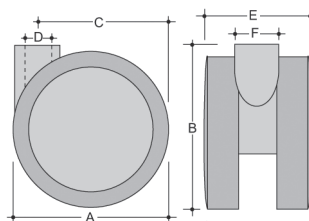

40 - DOPPIE RUOTE PIVOTANTI Ø 50 / TWIN CASTORS Ø 50

Doppia ruota Ø 50 in PA (ROLLER) / Twin-castor Ø 50 (ROLLER) in PA

DRG

Codice Code	GAMBO MONTATO PIN ASSEMBLED gambo Ø11 pin Ø11	Da Utilizzare con gambi filettati e piastre To use with threaded pin and iron plate	A	B	C	D	E	Nero/Black		
								€	Pz x conf Pcs/box-bag	Lotto min Min order
11.25.307.80.N3	V	-	Ø50	57.5	50.5	Ø10	55.5	-	250	250
11.25.303.80.N	-	V	Ø50	57.5	50.5	Ø8	55.5	-	300	300

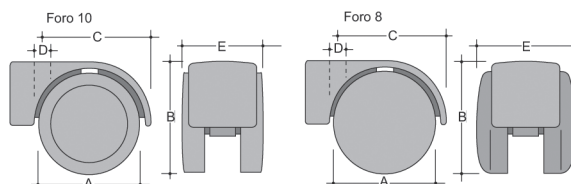

Doppia ruota Ø 50 in PA autofrenante / Twin-castor Ø 50 in PA self-braking

DRA

Codice Code	GAMBO MONTATO PIN ASSEMBLED gambo Ø11 pin Ø11	Da Utilizzare con gambi filettati e piastre To use with threaded pin and iron plate	A	B	C	D	E	Nero/Black		
								€	Pz x conf Pcs/box-bag	Lotto min Min order
11.25.263.83.N3	V	-	Ø50	57.5	50.5	Ø10	55.5	-	250	250
11.25.262.83.N	-	V	Ø50	57.5	50.5	Ø8	55.5	-	300	5000

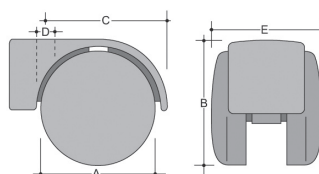

## DRS

### Doppia ruota Ø 50 in PA (GLASS) / Twin-castor Ø 50 in PA (GLASS)

Codice Code	GAMBO MONTATO PIN ASSEMBLED gambo Ø11 pin Ø11	Da Utilizzare con gambi filettati e piastre To use with threaded pin and iron plate	A	B	C	D	E	F	Nero/Black		
									€	Pz x conf Pcs/box- bag	Lotto min Min order
11.25.270.23.N3	V	-	Ø50	55	48.5	Ø10	54	35	-	250	250
11.25.271.23.N	-	V	Ø50	55	48.5	Ø8	54	35	-	300	5000

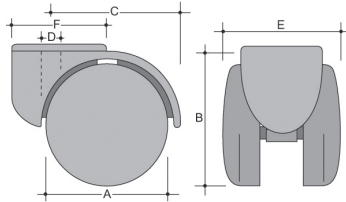

## DRGC

### Doppia ruota Ø 50 in PA (GLASS) / Twin-castor Ø 50 in PA (GLASS)

Codice Code	GAMBO MONTATO PIN ASSEMBLED gambo Ø11 pin Ø11	Da Utilizzare con gambi filettati e piastre To use with threaded pin and iron plate	A	B	C	D	E	Cromato+Nero Black+ Chrome plated		
								€	Pz x conf Pcs/box- bag	Lotto min Min order
11.25.380.80.C3	V	-	Ø50	56	50.5	Ø10	55.5	-	200	200
11.25.381.80.C	-	V	Ø50	56	50.5	Ø8	55.5	-	250	2500

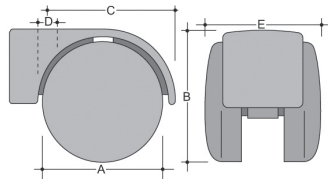

## DRV

### Doppia ruota Ø 50 in PA / Twin-castor Ø 50 in PA

Codice Code	GAMBO MONTATO PIN ASSEMBLED gambo Ø11 pin Ø11	A	B	C	D	E	F	Nero/Black		
								€	Pz x conf Pcs/box- bag	Lotto min Min order
11.25.274.23.N3	V	Ø50	57,5	51	Ø10	55	41,5	-	200	200

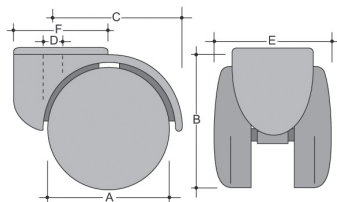

Doppia ruota Ø 50 in PA autofrenante / Twin-castor Ø 50 in PA self-braking

DRVA

Codice Code	GAMBO MONTATO PIN ASSEMBLED gambo Ø11 pin Ø11	A	B	C	D	E	F	Nero/Black		
								€	Pz x conf Pcs/box-bag	Lotto min Min order
11.25.277.84.N3	V	Ø50	57,5	51	Ø10	55	41,5	-	200	200

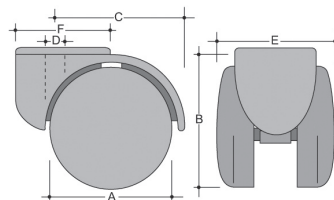

Doppia ruota Ø 50 in PA autofrenante (ricoperta in TPU)  
Twin-castor Ø 50 in PA self-braking (covered with TPU)

DRAD

Codice Code	GAMBO MONTATO PIN ASSEMBLED gambo Ø11 pin Ø11	Da Utilizzare con gambi filettati e piastre To use with threaded pin and iron plate	A	B	C	D	E	Nero/Black		
								€	Pz x conf Pcs/box-bag	Lotto min Min order
11.25.264.56.N3	V	-	Ø50	57.5	50.5	Ø10	55.5	-	200	200
11.25.265.56.N	-	V	Ø50	57.5	50.5	Ø8	55.5	-	250	5000

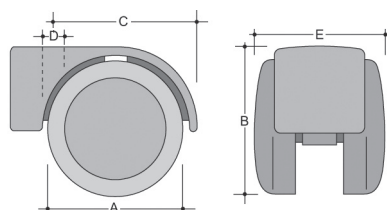

Doppia ruota Ø 50 in PA (ricoperta in TPU)  
Twin-castor Ø 50 in PA (covered with TPU)

DRSD

Codice Code	GAMBO MONTATO PIN ASSEMBLED gambo Ø11 pin Ø11	A	B	C	D	E	F	Nero/Black		
								€	Pz x conf Pcs/box-bag	Lotto min Min order
11.25.272.55.N3	V	Ø50	55	48.5	Ø10	54	35	-	200	200

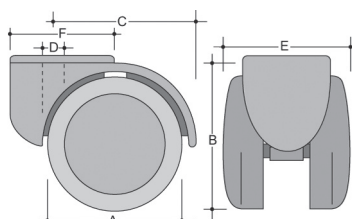

## DRVD

Doppia ruota Ø 50 in PA (ricoperta in TPU)  
Twin-caster Ø 50 in PA (covered with TPU)

Codice Code	GAMBO MONTATO PIN ASSEMBLED gambo Ø11 pin Ø11	A	B	C	D	E	F	Nero/Black		
								€	Pz x conf Pcs/box-bag	Lotto min Min order
11.25.275.55.N3	V	Ø50	57.5	51	Ø10	55	41.5	-	200	200

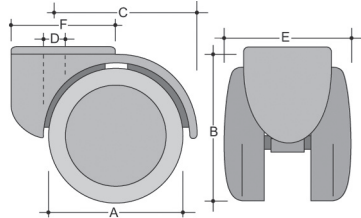

## DRVAD

Doppia ruota Ø 50 in PA (ricoperta in TPU) autofrenante  
Twin-caster Ø 50 in PA self-braking (covered with TPU)

Codice Code	GAMBO MONTATO PIN ASSEMBLED gambo Ø11 pin Ø11	A	B	C	D	E	F	Nero/Black		
								€	Pz x conf Pcs/box-bag	Lotto min Min order
11.25.278.56.N3	V	Ø50	57.5	51	Ø10	55	41.5	-	200	200

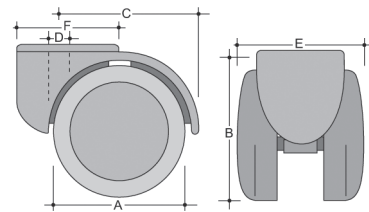

## DRGDC

Doppia ruota Ø 50 cromata (ricoperta in TPU)  
Chromed twin-caster Ø 50 (covered with TPU)

Codice Code	GAMBO MONTATO PIN ASSEMBLED gambo Ø11 pin Ø11	A	B	C	D	E	Nero/Black		
							€	Pz x conf Pcs/box-bag	Lotto min Min order
11.25.385.55.C3	V	Ø50	57.5	50.5	Ø10	55.5	-	200	200

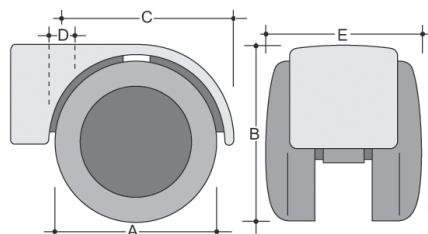

Doppia ruota Ø 50 in PA (CIP) con freno  
Twin-castor Ø 50 in PA (CIP) with brake

DRGD

Codice Code	GAMBO MONTATO PIN ASSEMBLED gambo Ø11 pin Ø11	Da Utilizzare con gambi filettati e piastre To use with threaded pin and iron plate	A	B	C	D	E	Nero/Black		
								€	Pz x conf Pcs/box-bag	Lotto min Min order
11.25.291.55.N3	V	-	Ø50	57.5	50.5	Ø10	55.5	-	200	200
11.25.292.55.N	-	V	Ø50	57.5	50.5	Ø8	50.5	-	250	250

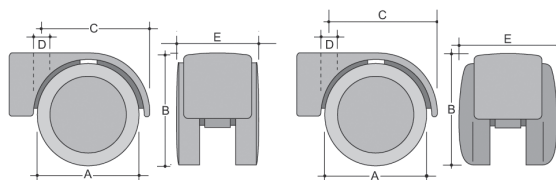

Doppia ruota Ø 50 in PA (CIP) con freno / Twin-castor Ø 50 in PA (CIP) with brake

DRCB

Codice Code	GAMBO MONTATO PIN ASSEMBLED gambo Ø11 pin Ø11	Da Utilizzare con gambi filettati e piastre To use with threaded pin and iron plate	A	B	C	D	E	Nero/Black		
								€	Pz x conf Pcs/box-bag	Lotto min Min order
11.25.287.23.N3	V	-	Ø50	56	47	Ø10	53.5	-	200	200
11.25.286.23.N	-	V	Ø50	56	47	Ø8	53.5	-	250	250

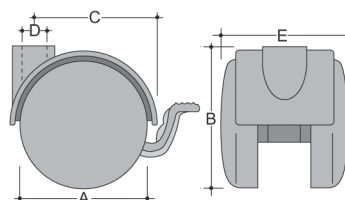

## DRM

Doppia ruota Ø 50 maxi con perno Ø 11 montato  
Twin-caster Ø 50 maxi with 11 mm pin assembled

Codice Code	A	B	C	D	E	Nero/Black		
						€	Pz x conf Pcs/box-bag	Lotto min Min order
21.25.293.00.N3	50	62	59	8	68	-	150	150

## DRMA

Doppia ruota Ø 50 maxi con perno Ø 11 montato  
Twin-caster Ø 50 maxi with 11 mm pin assembled

Codice Code	A	B	C	D	E	Nero/Black		
						€	Pz x conf Pcs/box-bag	Lotto min Min order
21.25.294.00.N3	50	62	59	8	68	-	100	3600

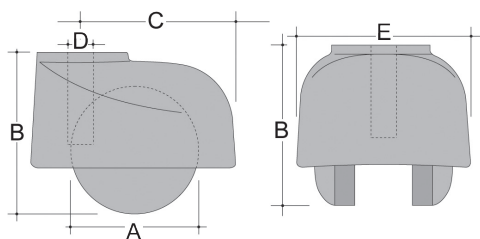

## DRK

Doppia ruota Ø 50 / Twin-caster Ø 50

Codice Code	GAMBO MONTATO PIN ASSEMBLED gambo Ø11 pin Ø11	Da Utilizzare con gambi filettati e piastre To use with threaded pin and iron plate	A	B	C	D	E	F	Nero/Black		
									€	Pz x conf Pcs/box-bag	Lotto min Min order
11.25.401.23.N3	V	-	Ø50	52	43	Ø10	46	21	-	250	250
11.25.400.23.N	-	V	Ø50	52	43	Ø8	46	21	-	300	5000

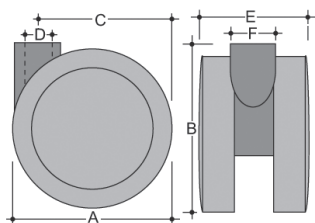

## DRKA

Doppia ruota Ø 50 autofrenante / Twin-caster Ø 50 self-braking

Codice Code	GAMBO MONTATO PIN ASSEMBLED gambo Ø11 pin Ø11	Da Utilizzare con gambi filettati e piastre To use with threaded pin and iron plate	A	B	C	D	E	F	Nero/Black		
									€	Pz x conf Pcs/box-bag	Lotto min Min order
11.25.403.83.N3	V	-	Ø50	52	43	Ø10	46	21	-	250	250
11.25.402.83.N	-	V	Ø50	52	43	Ø8	46	21	-	300	5000

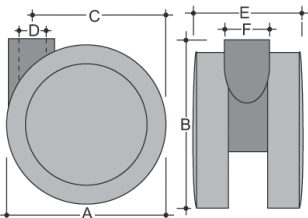

Doppia ruota Ø 50 / Twin-castor Ø 50

DRKD

Codice Code	GAMBO MONTATO PIN ASSEMBLED gambo Ø11 pin Ø11	Da Utilizzare con gambi filettati e piastre To use with threaded pin and iron plate	A	B	C	D	E	F	Nero/Black		
									€	Pz x conf Pcs/box-bag	Lotto min Min order
11.25.405.55.N3	V	-	Ø50	52	43	Ø10	46	21	-	200	200
11.25.404.55.N	-	V	Ø50	52	43	Ø8	46	21	-	250	5000

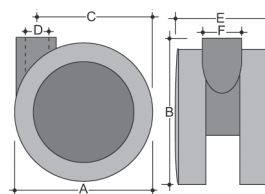

Doppia ruota Ø 50 autofrenante (ricoperta in TPU)  
Twin-castors Ø 50 self-braking (covered with TPU)

DRKAD

Codice Code	GAMBO MONTATO PIN ASSEMBLED gambo Ø11 pin Ø11	Da Utilizzare con gambi filettati e piastre To use with threaded pin and iron plate	A	B	C	D	E	F	Nero/Black		
									€	Pz x conf Pcs/box-bag	Lotto min Min order
11.25.406.56.N3	V	-	Ø50	52	43	Ø10	46	21	-	200	200
11.25.407.56.N	-	V	Ø50	52	43	Ø8	46	21	-	250	5000

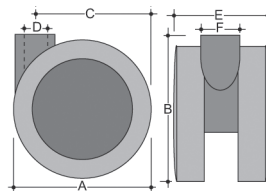

Doppia ruota Ø 50 (FAST) / Twin-castors Ø 50 (FAST)

DRN

Codice Code	GAMBO MONTATO PIN ASSEMBLED gambo Ø10-11 pin Ø10-11	Da Utilizzare con gambi filettati e piastre To use with threaded pin and iron plate	A	B	C	D	E	Nero/Black		
								€	Pz x conf Pcs/box-bag	Lotto min Min order
11.25.280.73.N	V	-	Ø50	55	48	Ø10	54	-	250	250
11.25.281.73.N	-	V	Ø50	55	48	Ø8	54	-	300	300

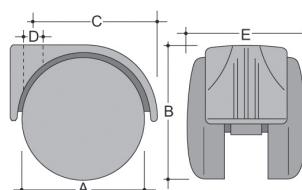

## Doppia ruota Ø 50 in PP (CIP) / Twin-castor Ø 50 (CIP) in PP

Codice Code	GAMBO MONTATO PIN ASSEMBLED gambo Ø11 pin Ø11	Da Utilizzare con gambi filettati e piastre To use with threaded pin and iron plate	A	B	C	D	E	Nero/Black		
								€	Pz x conf Pcs/box- bag	Lotto min Min order
11.25.297.73 N3	V	-	Ø50	56	47	Ø10	53.5	-	250	250
11.25.295.73 N	-	V	Ø50	56	47	Ø8	53.5	-	300	300

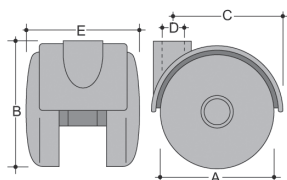

# 41 - DOPPIE RUOTE PIVOTANTI Ø47-40-36-35-30 / TWIN-CASTORS Ø47-40-36-35-30

## Rotella Libera Ø 47 / Free-wheel Ø 47

RTL

Codice Code	A	B	C	D	Nero/Black		
					€	Pz x conf Pcs/box-bag	Lotto min Min order
11.25.156.02	47	13	15	6.5	-	1250	1250

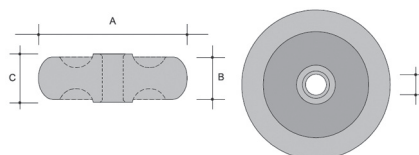

## Doppia ruota Ø 40 in PA (CIP) / Twin-castor Ø 40 in PA (CIP)

DRC

Codice Code	GAMBO MONTATO PIN ASSEMBLED gambo Ø11 pin Ø11	Da Utilizzare con gambi filettati e piastre To use with threaded pin and iron plate	A	B	C	D	E	Nero/Black		
								€	Pz x conf Pcs/box-bag	Lotto min Min order
11.25.301.23 N3	V	-	Ø40	43.5	38	Ø10	38.5	-	400	5000



## Doppia ruota Ø 40 in PP (CIP) / Twin-castor Ø 40 in PP (CIP)

11.25.298.73.N	-	V	Ø40	43.5	38	Ø8	38.5	-	500	500
----------------	---	---	-----	------	----	----	------	---	-----	-----

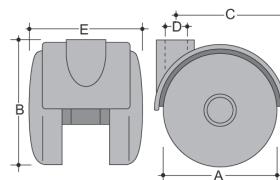

## Doppia ruota Ø 36 "large" per cassetiera / Twin-castor Ø 36 ("large") for drawer

DRBL

Codice Code	Da Utilizzare con gambi filettati e piastre To use with threaded pin and iron plate	A	B	C	D	E	Nero/Black		
							€	Pz x conf Pcs/box-bag	Lotto min Min order
11.25.360.23.N	V	Ø36	37	34	Ø8	51	-	500	1000

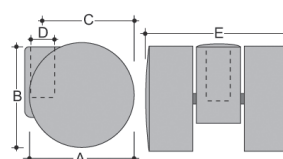

## DRBLB



### Doppia ruota Ø 36 "large" per cassettera / Twin-caster Ø 36 "large" for drawer

Codice Code	Da utilizzare con gambi filettati e piastre To use with threaded pin and iron plate	A	B	C	D	E	Nero/Black		
							€	Pz x conf Pcs/box- bag	Lotto min Min order
11.25.362.23.N	V	Ø36	37	34	Ø8	51	-	500	1000

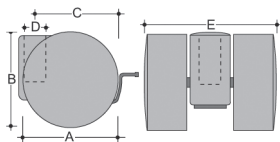

## DRB



### Doppia ruota Ø 36 in PA per cassettera / Twin-caster Ø 36 in PA "large" for drawer

Codice Code	Da utilizzare con gambi filettati e piastre To use with threaded pin and iron plate	A	B	C	D	E	Nero/Black		
							€	Pz x conf Pcs/box- bag	Lotto min Min order
11.25.267.23.N	V	Ø36	37	34	Ø8	40	-	500	1000

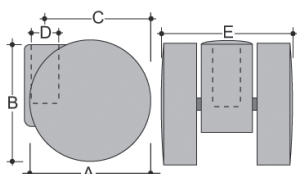

## DRBD



### Doppia ruota Ø 36 in PA (ricoperta in TPU) Twin-caster Ø 36 in PA "large" for drawer (covered with TPU)

Codice Code	Da utilizzare con gambi filettati e piastre To use with threaded pin and iron plate	A	B	C	D	E	Nero/Black		
							€	Pz x conf Pcs/box- bag	Lotto min Min order
11.25.390.55.N	V	Ø36	37	34	Ø8	40	-	500	1000

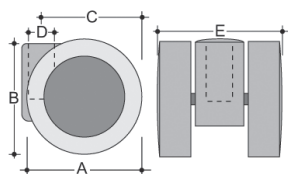

Doppia ruota Ø 35 per fioriera completa di gambo  
*Twin-castor Ø 35 pin for flowers pot holder*

DRPF

Codice Code	A	B	C	D	E	F	Nero/Black		
							€	Pz x conf Pcs/box- bag	Lotto min Min order
11.25.268.05	35	38	35	29	20	Ø10	-	800	800
11.25.379.05	35	38	35	29	-	Ø14	-	800	800

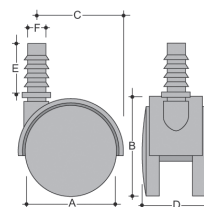

Doppia ruota Ø 30 con riduttore 5 alette / *Twin-castor Ø 30 with ribbed reduction*

Codice Code	A	B	C	D	E	F	Nero/Black		
							€	Pz x conf Pcs/box- bag	Lotto min Min order
29.10.175.00	29	67	33	Ø12	31	-	-	800	800

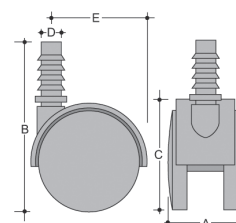



- |    |  |        |
|----|--|--------|
| 01 | GRP Gambo testa esagonale per ruote per pannelli / <i>Pin for panel-tray support</i>                   | pg.149 |
| 02 | SRPL Supporto ruote per pannelli da 16mm con 1 foro di fissaggio / <i>One hole support for panels</i>  | pg.149 |
| 03 | DRBL Doppia ruota Ø 36 "large" in PA per cassettera / <i>Twin-castor Ø 36 in PA "large" for drawer</i> | pg.145 |

Supporto ruote per pannelli da 16mm con 1 foro di fissaggio  
One hole support for panels

SRPL

Codice Code	A	B	C	D	E	F	G	H	I	Nero/Black		
										€	Pz x conf Pcs/box- bag	Lotto min Min order
11.25.216.02	45	9	15	8	28	10	12	22	16	-	-	20000

Gambo testa esagonale per ruote per pannelli / Pin for panel-tray support

GRP

Codice Code	L	M	N	O	P	Q	Zincocromato / Zinc plated		
							€	Pz x conf Pcs/box- bag	Lotto min Min order
21.25.420.00F	3	33	36	3.65	8	12	-	1200	20000

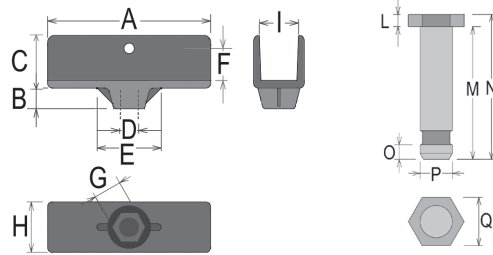

Supporto ruote per pannelli da 15mm con 2 fori di fissaggio  
Two holes support for panels

-

Codice Code	A	B	C	D	E	F	G	H	I	Nero/Black		
										€	Pz x conf Pcs/box- bag	Lotto min Min order
19.16.175.02	70	9	33	8	28	14	12	21	15	-	1000	20000

Gambo testa esagonale per ruote per pannelli / Pin for panel-tray support

GRP

Codice Code	L	M	N	O	P	Q	Zinco-cromato / Zinc plated		
							€	Pz x conf Pcs/box- bag	Lotto min Min order
21.25.420.00F	3	33	36	3.65	8	12	-	1200	20000

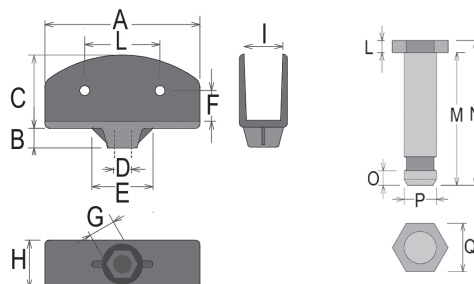

## 42 - PERNI PER RUOTE E BASI PIVOTANTI / PINS FOR CASTORS AND GLIDES

### GPB

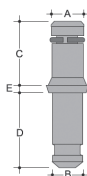

#### Gambo per basi sedie in FE zincocromato / Iron zinc plated pin for bases

Codice Code	A	B	C	D	E	Zinco-cromato / Zinc plated		
						€	Pz x conf Pcs/box-bag	Lotto min Min order
21.25.313.00	Ø11	Ø10	20	23.5	2.5	-	-	-
21.25.338.00	Ø10	Ø10	20	23.5	2.5	-	-	-

### GFR

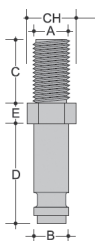

#### Gambo filettato in FE zincocromato / Iron zinc-plated threaded pin

Codice Code	A	B	C	D	E	CH	Zinco-cromato / Zinc plated		
							€	Pz x conf Pcs/box-bag	Lotto min Min order
21.25.312.00	M6	8	10	23	5	10	-	-	-
21.25.318.00	M8	8	10	23	5	10	-	-	-
21.25.310.00	M8	8	15	23	5	10	-	-	-
21.25.326.00	M8	8	30	23	5	10	-	-	-
21.25.311.00	M10	8	15	23	5	12	-	-	-
21.25.325.00	M10	8	18	23	5	12	-	-	-

### GPR

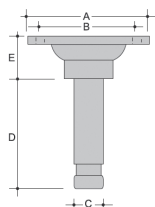

#### Gambo con piastra quadra in FE zincocromato / Iron zinc-plated plate

Codice Code	A	B	C	D	E	Zinco-cromato / Zinc plated		
						€	Pz x conf Pcs/box-bag	Lotto min Min order
21.25.309.00	28X28	19X19	8	23	10	-	-	-
21.25.337.00	38X38	27X27	8	23	10	-	-	-
21.25.336.00	42X42	32X32	8	23	13	-	-	-

### GHI

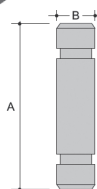

#### Gambo attacco HI-FI in FE zincocromato / Iron zinc-plated pin for HI-FI

Codice Code	A	B	Zinco-cromato / Zinc plated		
			€	Pz x conf Pcs/box-bag	Lotto min Min order
11.25.330.65	37	Ø8	-	-	10000

Gambo godronato in FE zincocromato / Zinc plated knured pin

GGR

Codice Code	A	B	C	D	E	Zinco-cromato -godronato /Zinc-plated		
						€	Pz x conf Pcs/box-bag	Lotto min Min order
21.25.308.00	8	8	20	23	4	-	-	-

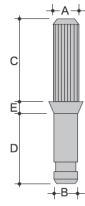

43 - DOPPIE RUOTE PIVOTANTI Ø50 / TWIN-CASTORS Ø50

Ruota Ø50 "OTO50" / Castor Ø50 "OTO50"

OTO50

Codice Code	A	B	C	D	E	Nero/Black		
						€	Pz x conf Pcs/box-bag	Lotto min Min order
11.25.453.73	Ø50	54	Ø7	60	51	-	500	500

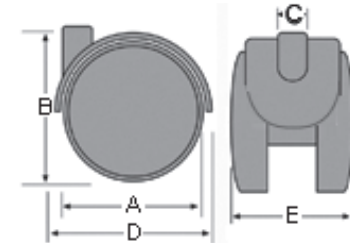

Ruota Ø50 "OTO50" con freno / Castor Ø50 "OTO50" with brake

OTO50CF

Codice Code	A	B	C	D	E	Nero/Black		
						€	Pz x conf Pcs/box-bag	Lotto min Min order
11.25.455.80	Ø50	54	Ø7	75	51	-	500	500

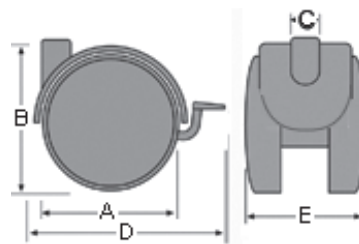

Ruota Ø50 "OTO50" con gomma/ Castor Ø50 "OTO50" with rubber

OTO50RG

Codice Code	A	B	C	D	E	Nero/Black		
						€	Pz x conf Pcs/box-bag	Lotto min Min order
11.25.462.74	Ø50	54	Ø7	60	51	-	500	500

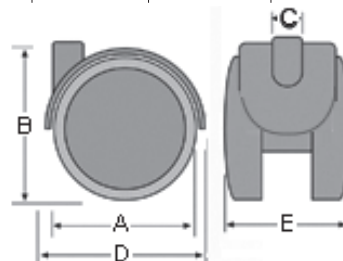

## OTO40

### Ruota Ø40 "OTO40" / Castor Ø40 "OTO40"

Codice Code	A	B	C	D	E	Nero/Black		
						€	Pz x conf Pcs/box-bag	Lotto min Min order
11.25.450.73	Ø40	46	Ø7	49	46	-	400	400

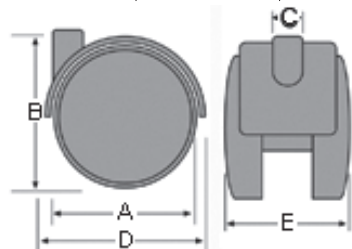

## OTO40CF

### Ruota Ø50 "OTO40" con freno / Castor Ø40 "OTO40" with brake

Codice Code	A	B	C	D	E	Nero/Black		
						€	Pz x conf Pcs/box-bag	Lotto min Min order
11.25.451.80	Ø40	46	Ø7	64	46	-	500	500

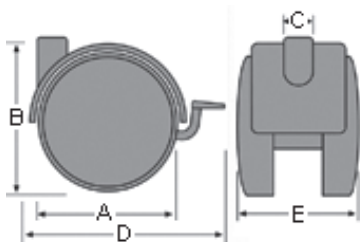

## OTO40RG

### Ruota Ø40 "OTO40" con gomma / Castor Ø40 "OTO40" with rubber

Codice Code	A	B	C	D	E	Nero/Black		
						€	Pz x conf Pcs/box-bag	Lotto min Min order
11.25.452.74	Ø40	46	Ø7	49	46	-	500	500

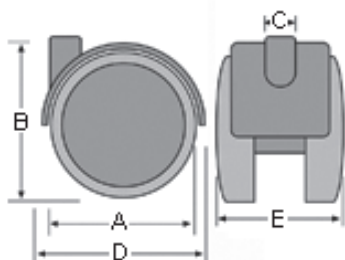

## SAR40

### Ruota Ø40 "SAR40" / Castor Ø40 "SAR40"

Codice Code	A	B	C	D	E	Nero/Black		
						€	Pz x conf Pcs/box-bag	Lotto min Min order
11.25.464.73	Ø40	46	Ø7	48	46	-	500	500

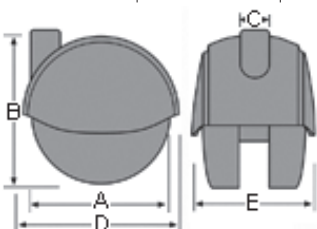

Ruota Ø35 "SAR35" / Castor Ø35 "SAR35"

SAR35

Codice Code	A	B	C	D	E	Nero/Black		
						€	Pz x conf Pcs/box-bag	Lotto min Min order
11.25.463.73 *	Ø35	42	Ø7	44	35	-	500	500

\* Non compatibile con GFRO M8X30 - cod. 21.25.474.00  
 \* Not compatible with GFRO M8X30 - cod. 21.25.474.00

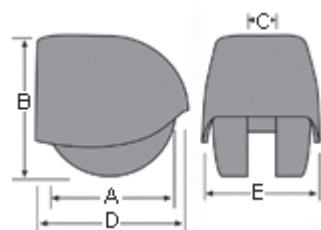

Ruota Ø35 "ECO35" / Castor Ø35 "ECO35"

ECO35

Codice Code	A	B	C	D	E	Nero/Black		
						€	Pz x conf Pcs/box-bag	Lotto min Min order
11.25.465.73	Ø35	38	Ø7	40	35	-	500	500

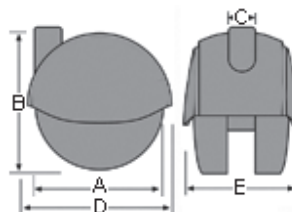

45-PERNI RUOTE PIVOTANTI OTO-SAR-ECO/STEMS FOR CASTORS OTO-SAR-ECO

Gambo ruota filettato / Threaded pivot

GFRO

Codice Code	A	B	C	D	E	Zinco-cromato / Zinc plated		
						€	Pz x conf Pcs/box-bag	Lotto min Min order
21.25.471.00	M8	15	27	Ø7	12	-	-	-
21.25.472.00	M10	15	27	Ø7	12	-	-	-
21.25.474.00 *	M8	30	24	Ø7	10	-	-	-
21.25.478.00	M6	25	24	Ø7	10	-	-	-

\* Non compatibile con SAR 35 - cod. 11.25.463.73  
 \* Not compatible with SAR 35 - cod. 11.25.463.73

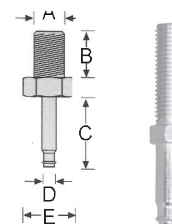

Gambo ruota filettato con rondella / Threaded pivot with ring

GFRR

Codice Code	A	B	C	D	E	Zinco-cromato / Zinc plated		
						€	Pz x conf Pcs/box-bag	Lotto min Min order
21.25.477.00	M8	10	27	Ø7	10	-	-	-

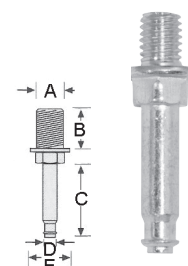

## GFRQ

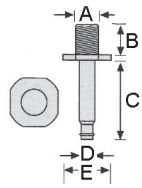

### Gambo ruota filettato con quadro / Threaded pivot with square bush

Codice Code	A	B	C	D	E	Zinco-cromato / Zinc plated		
						€	Pz x conf Pcs/box-bag	Lotto min Min order
21.25.479.00	M8	10	26.5	Ø7	17.8	-	-	-

## GGRO

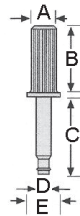
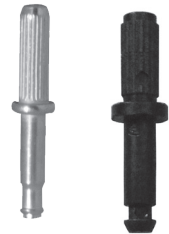

### Gambo ruota godronato / Knurled pivot

Codice Code	PA	A	B	C	D	E	-		
							€	Pz x conf Pcs/box-bag	Lotto min Min order
21.25.481.00	-	8	12	27	Ø7	12.5	-	-	-
21.25.482.00	-	8	20	27	Ø7	12	-	-	-
11.25.495.05	V	8	20	27	Ø7	12	-	-	-
11.25.496.05	V	10	20	27	Ø7	12	-	-	-
11.25.497.05	V	12	20	27	Ø7	15.5	-	-	-

## GPRO

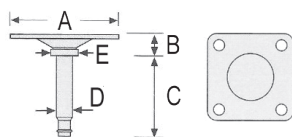

### Gambo con piastra / Pivot with plate

Codice Code	A	B	C	D	E	Zinco-cromato / Zinc plated		
						€	Pz x conf Pcs/box-bag	Lotto min Min order
21.25.487.00	28x28	10	27	Ø7	12	-	-	-
21.25.488.00	38x38	10	27	Ø7	12	-	-	-
21.25.489.00	42x42	10	27	Ø7	12	-	-	-

## GLRO

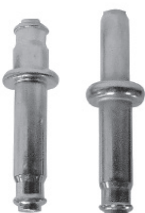

\*

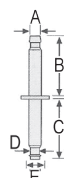

### Gambo liscio o a scatto / Smooth snap stem

Codice Code	A scatto* Snap*	A	B	C	D	E	Zinco-cromato / Zinc plated		
							€	Pz x conf Pcs/box-bag	Lotto min Min order
21.25.491.00	-	6	28	24	Ø7	12.5	-	-	-
21.25.492.00	V	7	26.5	26.5	Ø7	12.5	-	-	-
21.25.493.00	V	8	12.5	27	Ø7	12.5	-	-	-
21.25.494.00	-	6	17	24	Ø7	12.5	-	-	-

Gambo con testa bombata / *Roundheaded pivot*

Codice Code	A	B	C	D	E	Zinco-cromato / Zinc plated		
						€	Pz x conf Pcs/box-bag	Lotto min Min order
21.25.498.00	11	20	27	Ø7	14	-	-	-

GLBO

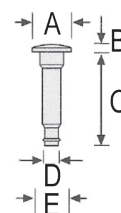

Gambo con seeger montato / *Stem with assembled seeger*

Codice Code	A	B	C	D	E	Zinco-cromato / Zinc plated		
						€	Pz x conf Pcs/box-bag	Lotto min Min order
21.25.486.00	11	20	27	Ø7	14	-	-	-

GPBO

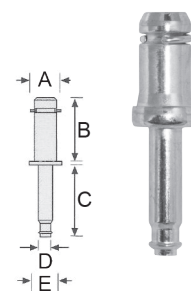

46 - ATTREZZI / *TOOLINGS*

Chiave esagonale per gambi rotelle in FE zincocromato  
*Iron zinc-plated hexagonal spanner*

Codice Code	A	B	C	D	-		
					€	Pz x conf Pcs/box-bag	Lotto min Min order
11.25.320.67	10	12	15	80	-	1000	1000
11.25.322.67	12	13	15	80	-	1000	5000

CER

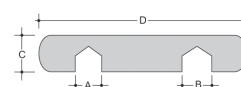

Cacciavite a croce / *Cross screwdriver*

Codice Code	A	B	C	D	-		
					€	Pz x conf Pcs/box-bag	Lotto min Min order
29.05.130.00	40	47	5.5	25	-	1000	1000

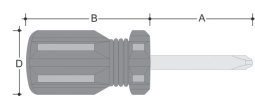

-	Cacciavite a croce/ <i>Crossed screwdriver</i>	155	CM	Copritesta tubi in FE imbutito / <i>Round insert in metal</i>	18
-	Doppia ruota Ø 30 con riduttore 5 alette <i>Twin-castor Ø30 with 5 ribbed reduction</i>	147	CMR	Copritesta per molle reti in PE neutro <i>Cover caps for net spring in neutral PE</i>	65
-	Gambo filettato per piedino cucine / <i>Threaded stem for kitchen foot</i>	129	COC	Copritesta ovali in ABS- nero-cromato metallizzato <i>Oval insert in ABS black chrome brass plated</i>	31
-	Piede per base armadio in PPN / <i>PPN cabinet foot for wardrobe</i>	122	COI	Copritesta ovali alettati in PE/ <i>Ribbed oval insert in PE</i>	32
-	Supporto ruote per pannelli, con 2 fori/ <i>Two holes support for panels</i>	149	COM	Copritesta in PE ovale con testa in FE cromato <i>Ribbed oval insert in PE with metal top</i>	31
3R	Riduttori rigati per ruote in PP/ <i>Striped adapter for castors in PP</i>	81	CONI	Copritesta ovale per tubo ovale <i>Oval cover cap for oval tube</i>	32
ADP	Agganci e distanziale per sedia a pozzetto / <i>Links and spacer for armchair</i>	131	CPA	Copriforo tubo Ø 50 spess. 1 mm per appendiabito <i>Cover cap for tube Ø 50 for cloth hanger</i>	68
ADS	Puntali doppio angolare in PE / <i>Double angle insert in PE</i>	40	CPO	Cassetto portaoggetti scorrevole/ <i>Object-trayer</i>	93
AGO	Agganci ad omega in PP / <i>Hooks in PP</i>	50	CPOP	Cassetto portaoggetti scorrevole con pioli <i>Object-trayer with pags</i>	93
AO	Attaccapanni ovale in PP/ <i>Oval clothes stand in PP</i>	76	CPR	Coppia pinze regolabili per tubo ovale 15x30 in PP <i>Clips for oval tube 15x30 in PP</i>	63
AO2	Attaccapanni rigido in PP / <i>Rigid clothes stand in PP</i>	76	CPRX	Coppia pinze regolabili per tubo Ø 18-20 in PP <i>Clips for tube Ø 18-20 in PP</i>	63
AP4	Appendino a 4 posti Ø50 / <i>Cloth hanger 4 places Ø50</i>	68	CPTA	Copritesta o puntali ovali testa alta in PE <i>Ribbed oval insert large head in PE</i>	32
APF2	Appendino porta flebo 2 posti/ <i>Drip bag trayer 2 places</i>	96	CPTA1	Copritesta ovali testa alta 1 aletta in PE/ <i>One rib oval insert in PE</i>	32
APP	Supporto appendiabiti/ <i>Clothes-hook support</i>	68	CQI	Copritesta quadri in PE / <i>Square inserts in PE</i>	22
AS	Anello sottopiede in PVC / <i>Feet ring in PVC</i>	47	CQM	Copritesta in PE con testa in FE cromato <i>Square inserts in PE with metal top</i>	22
ASC	Puntali per angolari in PE / <i>Angle insert in PE</i>	40	CR	Copritesta reti letto in PE nero / <i>Cover caps for nets in black PE</i>	65
ASL	Puntali per angolari a L in PE / <i>Angle insert L type in PE</i>	41	CRG	Copritesta rettangolari in ABS - nero - cromato metallizzato ottone <i>Rectangular insert in ABS - black - Chrome brass plated</i>	27
ASPF	Attacco superiore porta flebo/ <i>Top joint for drip trayer</i>	96	CRI	Copritesta rettangolari alettati in PE/ <i>Rectangular tube cover in PE</i>	26
AUS	Puntali angolari a U in PVC / <i>Angle bases U type in PVC</i>	41	CRI	Copritesta/puntali rettang. alettati in PE/ <i>Ribbed rectangular insert in PE</i>	24
AXA	Anello per appendiabiti in PP / <i>Ring for stan-cloth in PP</i>	70	CRIE	Copritesta in PP estetici rettangolari / <i>Rectangular insert in PP</i>	27
B4G	Bussole filettate in FE / <i>Iron T-nut in FE</i>	113	CRL	Copricerniere per reti letto / <i>Hinge cover for bed frames</i>	66
BAR	Buccola autofilettante a ragno in PA <i>Spider T-nut in PA (Suited for the assembling of shells)</i>	113	CRIS	Copritesta rettangolare alettato in PE / <i>Rectangular insert in PE</i>	26
BCM	Blocchetto chiusura magnetica forza trazione Kg.4 <i>Magnetic closure with force traction of 4 Kg</i>	100	CRM	Copritesta in PP -testa in FE cromato <i>Ribbed inserts in PE and metal top</i>	17
BHI	Base attacco gambo HI-FI in PA / <i>Stem for HI-FI in PA</i>	132	CRTM	Copritesta in PE rettangolare con testa in FE <i>Chrome rectangular insert</i>	27
BLR	Blocchetto reggipiani in PP/ <i>Shelf support in PP</i>	98	CS	Copritesta a sfera in PVC / <i>Round ball in PVC</i>	18
BPO	Baccinella base portaombrelli in PP (1) <i>Umbrella stand basins in PP (1)</i>	74	CSA	Coprisaldatura per appendiabito / <i>Cover welding for cloth hanger</i>	74
BPO	Baccinelle portaombrelli ovali in PP (2) <i>Oval umbrella stand basins in PP (2)</i>	74	CSB	Coprisaldatura base 5 razze / <i>Welding cover for 5 legs bases</i>	49
BPO	Baccinelle portaombrelli rotonde in PP (3) <i>Round umbrella stand basins in PP (3)</i>	74	CSL	Cuscinetti per rivettatura a strappo in PA testa liscia <i>Ball bearings in PA with smooth head (Suitable for drawers and etc.)</i>	86
BPP	Base piana a pinza in PE per tondo 8 <i>Clip for chair wire metal for tube 8 mm</i>	33	CSO	Cuscinetti a sfera in PA/ <i>Ball bearing in PA (Suitable for drawers and etc.)</i>	85
BPP	Base piana a pinza in PE per tondo 10/ <i>Clip for chair wire metal for tube 10 mm</i>	33	CSPR	Copritesta semiovale porta ruote / <i>Semioval tube cover for castors</i>	48
BPP	Base piana a pinza in PE per tondo 12 / <i>Clip for chair wire metal for tube 12 mm</i>	33	CSS	Cuscinetti per rivettatura a strappo in PA <i>Ball bearings in PA (Suitable for drawers and etc.)</i>	86
BPP	Base piana a pinza in PE per tondo 14 / <i>Clip for chair wire metal for tube 14 mm</i>	34	CTM	Copritesta alettato in PE con testa in FE cromato <i>Ribbed inserts in PE with metal head</i>	16
BPPA	Base piana a pinza antirrotazione in PE per tondo 11 <i>Clip for chair wire metal for tube 11 mm non-turning</i>	34	CVIE	Copritesta viti a testa cilindrica in PE (con esagono incassato per vite 6MA) <i>Screw cover in PE (With exagon for screw 6MA)</i>	99
BPPD	Base piana a pinza doppia in PE per tondo 11 <i>Clip for chair wire metal for tube 11 mm non-turning</i>	34	DB	Tubetto distanziatore in PP / <i>Spacer in PP</i>	52
BPV	Basi pomoli in ABS/ <i>Bases for knobs in ABS</i>	106	DCA	Dadi con alette in PS antiurto con buccola in metallo filettata <i>Wing screws in PS with zinc-plated bolt</i>	112
BS	Bracciolo sagomato in PS tubo Ø 25 / <i>Curved armrest in PS - tube Ø 25</i>	50	DGA	Dadi con alette in PS antiurto con gambo FE zincocromato <i>Wing screws in PS with zinc-plated bolt</i>	112
BSB	Bracciolo sagomato in PS con buccole filett M6 - in ottone per tubo Ø 25 <i>Curved armrest in PS with threaded nuts for tube Ø 25</i>	50	DP	Distanziatore a pinza in PE / <i>Saddle feet in PE</i>	47
BSR	Bussola per reggipiani BLR in PP/ <i>T-nut for BLR in PP</i>	98	DPO	Disco porta ombrelli a 4 posti in PP / <i>Umbrella stand plate with 4 places in PP</i>	73
BTF	Piedini 4 pzi. per telaio a filo neutri <i>Set of 4 pcs of neutral glides for wireframes</i>	34	DPOC	Disco porta ombrelli a 4 posti in PP/ <i>Umbrella stand plate with 4 places in PP</i>	73
BTFA	Piedini 4 pzi con aggancio per telaio a filo <i>Set of 4 pcs of neutral glides with joint for wireframes</i>	34	DPOQ	Disco porta ombrelli a 4 posti in PP/ <i>Umbrella stand plate with 4 places in PP</i>	73
CCR	Copritesta alettato in PE / <i>Ribbed inserts in PE</i>	16	DR	Tubetto distanziatore in PE / <i>Spaces in PP</i>	52
CCRC	Copritesta a 1 aletta in PE / <i>Ribbed inserts in PE</i>	16	DRA	Doppia ruota Ø 50 in PA autofrenante (BRAKE) <i>Twin-castor Ø 50 with brake in PA</i>	137
CCRL	Copritesta alettato in PE / <i>Ribbed inserts in PE</i>	16	DRAD	Doppia ruota Ø 50 in PA autofrenante (ricoperta in TPU) <i>Twin-castor Ø 50 with brake in PA (covered with TPU)</i>	139
CEI	Copritesta a ellisse in PE / <i>Ribbed elliptical insert in PE</i>	31	DRB	Doppia ruota Ø 36 in PA per cassetiera <i>Twin-castor Ø36 in PA for drawer</i>	146
CEIS	Copritesta a ellisse in PE / <i>Ribbed elliptical insert in PE</i>	31	DRBD	Doppia ruota Ø 36 in PA (ricoperta in TPU) <i>Twin-castor Ø36 in PA (covered with TPU)</i>	146
CENI	Copritesta ovale per tubo ellittico/ <i>Oval cover cap for elliptical tube</i>	33	DRBL	Doppia ruota Ø 36 "large" per cassetiera <i>Twin-castor Ø36 ("large") for drawer</i>	145
CER	Chiave esagonale per gambi rotelle in FE zincocromato <i>Zinc plated hexagonal spanner</i>	155			
CESG	Cestino getta carta in PP / <i>Paper basket in PP</i>	94			
CFS	Copriforo per serramenti in PVC / <i>Tube cover for windows in PVC</i>	44			
CGQ	Copritesta galvanizzati quadri in ABS / <i>Square inserts in ABS</i>	23			
CGQ	Copritesta quadri in ABS/ <i>Square inserts in ABS</i>	23			
CGR	Copritesta tondi in ABS / <i>Round inserts in ABS</i>	18			
CGR	Copritesta tondi in ABS / <i>Round inserts in ABS</i>	19			

DRBLB	Doppia ruota Ø 36 "large" con freno manuale Twin-castor Ø36 ("large") for drawer	146
DRC	Doppia ruota Ø40 PA (CIP) / Twin-castor Ø40 in PA (CIP)	145
DRC	Doppia ruota Ø40 PP (CIP) / Twin-castor Ø40 in PP (CIP)	145
DRCB	Doppia ruota Ø50 in PA (CIP) con freno Twin-castor Ø50 in PA (CIP) with brake	141
DRCC	Doppia ruota Ø50 in PP (CIP) / Twin-castor Ø50 in PP (CIP)	144
DRG	Doppia ruota Ø50 in PA (ROLLER) / Twin-castor Ø 50 (ROLLER) in PA	137
DRGC	Doppia ruota Ø50 cromata (Roller) / Twin-castor Ø 50 in PA (ROLLER)	138
DRGD	Doppia ruota Ø50 in PA (ricop. in TPU) Twin-castor Ø 50 in PA (CIP) with brake	141
DRGDC	Doppia ruota Ø50 cromata (ricoperta in TPU) Chromed twin-castor Ø 50 (covered with TPU)	140
DRH	Doppia ruota Ø65 / Twin-castor Ø 65	135
DRHA	Doppia ruota Ø 65 autofrenante / Twin-castor Ø 65 with bracke	135
DRHAD	Doppia ruota Ø 65 autofrenante (ricoperta in PUR) Twin-castor Ø 65 with brake (covered with PUR)	136
DRHB	Doppia ruota Ø65 con freno / Twin-castor Ø 65 Ø 65 with brake	136
DRHC	Doppia ruota Ø 65 - Cromata / Chromed twin-castor Ø 65	136
DRHD	Doppia ruota Ø 65 (ricoperta in TPU) /Twin-castor Ø 65(covered with TPU)	135
DRHDC	Doppia ruota Ø65 (ricoperta in TPU)- Cromata / Chromed twin-castor Ø 65(covered with TPU)	137
DRK	Doppia ruota Ø50/ Twin-castor Ø50	142
DRKA	Doppia ruota Ø50 autofrenante/ Twin-castor Ø50 with brake	142
DRKAD	Doppia ruota Ø50 autofren (ricoperta in TPU) Twin-castor Ø50 (covered with TPU)	143
DRKD	Doppia ruota Ø50 (ricoperta in TPU)/ Twin-castor Ø50 with brake	143
DRM	Doppia ruota Ø 50 maxi con perno Ø 11 montato Twin-castor Ø50 maxy with 11 mm pin assembled	142
DRMA	Doppia ruota Ø 50 maxi autofrenante con perno Ø 11 montato Twin-castor Ø50 maxy with 11 mm pin assembled	142
DRN	Doppia ruota Ø50 (FAST) Twin-castor Ø50 (EAST)	143
DRPF	Doppia ruota Ø35 per fioriera completa di gambo Twin-castor Ø35 pin for flowers pot holder	147
DRS	Doppia ruota Ø50 in PA (GLASS) / Twin-castor Ø 50 in PA (GLASS)	138
DRSD	Doppia ruota Ø50 in PA (ricoperta in TPU) Twin-castor Ø 50 in PA (covered with TPU)	139
DRV	Doppia ruota Ø50 in PA / Twin-castor Ø 50 in PA	138
DRVA	Doppia ruota Ø50 in PA autofrenante / Twin-castor Ø 50 in PA with brake	139
DRVAD	Doppia ruota Ø50 in PA (ricoperta in TPU) autofrenante Twin-castor Ø 50 in PA with brake (covered with TPU)	140
DRVAD	Doppia ruota Ø50 in PA (ricoperta in TPU)/ Twin-castor Ø 50 in PA (covered with TPU)	140
DU01	Disco porta ombrelli TREE / Umbrella stand-plate TREE	73
DZB	Distanziatore bombato zigrinato in PE / Round spacer in PE	53
DZC	Distanziatore conico zigrinato in PE / Conic spacer in PE	53
DZL	Distanziatore liscio in PE / Round spacer in PE	53
EA	Puntali angolari in PE / Angle insert in PE	41
EAL	Puntali angolari base dritta in PE / Angle insert in PE	41
EB	Puntali a botte in PVC / Outer caps in PVC	37
EBI	Puntali per brande inclinato 20° in PE / Inclined 20° insert in PE	65
EC	Puntali a campana in PVC / Outer caps in PVC	36
ECO35	Ruota Ø35 "ECO35"/ Castor Ø35 "ECO35"	153
EIA	Puntali a ellisse alettati in PE / Ribbed elliptical insert in PE	28
EIAD	Puntali a ellisse alettati in PE / Ribbed elliptical insert in PE	28
EIADI	Puntali a ellisse inclinati 15° in PE / Elliptical inclined 15° ribbed insert in PE	29
EIAI	Punta ellisse inclin 10° in PE / Elliptical inclined ribbed insert 10°in PE	28
EIAS	Puntali a ellisse in PE / Ribbed elliptical insert in PE	28
EL	Puntali bombati lunghi in PVC / Outer caps in PVC	37
ERI	Puntali inclinati 20° in PVC / Round 20° inclined insert in PVC	38
ERL	Punt. est.rett 15x30 / Outer square caps 15x30 	38
ES	Espansori in PE per PSE 4 - 5 - 8 - 9 / Insert for PSE 4-5-8-9	125
ETL	Puntale esterno leggero in PE / Light outer caps in PE	37
EX	Puntali export in PVC / Outer caps in PVC	36
FBP	Ferma battute porte in PVC / Door buffer in PVC	55
FCPO	Fermo per cassetto portaoggetti/ Stop for object trayer	93
FCV	Fermacristalli con vite in FE con testa cromata o ottonata Glass blocking FE screws head chromed brassed	82

FP	Fermaportine in PS/ Doorstop in PS	100
GAS	Griglia per armadietti spogliatoio con appendino in PST Grid for locker with cloth hanger in PST	79
GASD	Griglia per armadietti spogliatoio con appendino in PST Grid for locker with cloth hanger in PST	79
GCS	Coppia guide con pioli per cassetto portaoggetti/ Pair of guides for object trayer	93
GFR	Gambo filettato in FE zincocromato/Iron zinc plated threaded pin	150
GFRO	Gambo ruota filettato / Threaded pivot	153
GFRQ	Gambo ruota filettato con quadro /Threaded pivot with square bush	154
GFRR	Gambo ruota filettato con rondella / Threaded pivot with ring	153
GGA	Giunto girevole per attaccapanni in PS / Turning joint in PS	72
GGR	Gambo godronato in FE zincocromato/ Zinc plated knured pin	151
GGRO	Gambo ruota godronato / Knurled pivot	154
GHI	Gambo attacco HI-FI in FE zincocromato/ Iron zinc plated pin for HI-FI	150
GLBO	Gambo con testa bombata / Roundheaded pivot	155
GLIA	Basi girevoli per sedie e mobili / Revolving glide for chairs and furniture	133
GLIC	Basi girevoli a campana per sedie e mobili / Revolving glide for chairs and furniture	132
GLICC	Basi gir a campana per sedie e mobili Revolving glide for chairs and furniture chrom	133
GLICI	Basi girevoli per sedie e mobili / Revolving glide for chairs and furniture	134
GLIO	Basi girevoli ovali per sedie e mobili / Oval revolving glide for chairs and furniture	133
GLIP	Basi girevoli per sedie e mobili / Revolving glide for chairs and furniture	134
GLIS	Piedi girevoli per sedie e mobili / Revolving glides for chairs and furniture	132
GLISC	Piedi gir. per sedie e mobili crom Revolving glides for chairs and furniture chrom	132
GLIT	Basi girevoli per sedie e mobili / Revolving glide for chairs and furniture	133
GLRO	Gambo liscio o a scatto / Smooth snap stem	154
GPB	Gambo per basi sedie in FE zincocromato/ Zinc plated stem with laking ring	150
GPBO	Gambo con seeger montato / Stem with assembled seeger	155
GPG	Gancio porta giacca in PA/ Hook for jacket in PA	79
GPL	Giunti porta aste letti in PP nero / Connectors in black PP	64
GPLD	Giunti porta aste letti doppi in PP nero / Double connectors in black PP	64
GPO	Gancio reggi ombrello spogliatoi in PP / Umbrella stand in PP	78
GPR	Gambo con piastra quadra in FE zincocromato// Iron zinc plated plate	150
GPRO	Gambo con piastra / Pivot with plate	154
GRA	Gancetto reggipiani per armadietti/ Shelf hook for locker	79
GRP	Gambo testa esagonale per ruote per pannelli / Pin for panel-tray support	149
GZC	Gancio per zoccolo cucine / Clip for kitchen leg	128
GZCI	Gancio per zoccolo cucine con imbocco / Clip for kitchen leg with entrance	129
HA01	Appendino 4 posti TREE / Cloth hanger 4 places mod. TREE	68
HM01	Appendiabito a muro TREE / Coat hook tree	76
IPF	Innesto porta flebo/Joint for drip bag trayer	96
IQC	Innesto quadro per letti a castello-PA neutro /Square connector for castle bed-neutral PA	62
IRA	Puntali alettati in PE / Ribbed inserts for round tubes in PE	10
IRA1	Puntale ad una aletta in PE / One rib insert in PE	10
IRA2	Puntale a due alette in PE / One rib insert in PE	10
IRAF	Puntali rotondi alettati e filettati in PP / Threaded round inserts in PP	11
IRAFS	Puntale alettato senza testa per tubo D20 / Ribbed inserts for round tubes in PE	11
IRAI	Puntali alettati inclinati 13° in PE/ Inclined ribbed inserts 13° in PE	14
IRAI	Puntali alettati inclinati 30° in PE / Inclined ribbed inserts 30° in PE	14
IRAP	Puntali alettati in PE a base alta / Ribbed inserts for round tubes in PE high head	11
IRC	Innesto tondo per letti a castello-PA neutro Round connector for castle-bed -neutral PA	62
IRG	Puntali per ghiera / Round inserts with large base	12
IRG	Ghiera per puntali / Metal ring for round inserts	12
IRGI	Puntali per ghiera inclin. 12° in PE/ Round inserts with large base PE inclined 12°	12
IRN	Puntali o sottopiedi in PVC / Ribbed inserts in PVC	13
IRTA	Puntale testa alta D22 H57.5 / High head insert D22 H57.5 	15
IRZI	Puntali con zoccolo inclinati 30° in PE / Inserts with inclined base 30° in PE	14
ITLA	Puntali copritesta, a testa liscia in PP / Cover tube with smooth head in PP	15
ITQ	Innesti per tubo quadro 20x20 in ABS / Tube connector for tube 20x20 in ABS	42
ITQ	Innesti per tubo quadro 25x25 in ABS / Tube connector for tube 25x25 in ABS	43
ITR	Innesto per tubi rotondi filettato in PA / Threaded connector for round tube in PA	13-72
ITR	Innesto per tubi rotondi in PS / Connectors for round tubes in PS	71
ITRV	Innesto c/vite per tubi rotondi in PS / Connector with screw for round tubes	70

ITSA	Puntali copriresta, a testa sferica alettati in PE / <i>Spherical round cover tube in PE</i>	14	PBC	Pomello con testa bombata in ABS filettati 4MA/ <i>Knob with convex head</i>	106
ITSA	Puntali copriresta, a testa sferica alettati in PE per tubo spessore 2 mm <i>Spherical round cover tube in PE, for tube thickness 2 mm</i>	15	PBF	Paracolpi con chiodo e base in feltro/ <i>Buffer with nail and base in felt</i>	61
ITSA2	Puntali copriresta, a testa emisferica in PP/ <i>Spherical round cover tube in PP</i>	15	PBRB	Reg in FE-base in plast-gambo e ghiera in FE zincocrom o otton <i>Non-tilt adjustable feet with plastic base and zinc-plated /brassed iron screw</i>	115
ITSC	Copriresta alettato in PE con testa sferica in FE cromato <i>Ribbed insert in PE with round metal head</i>	17	PBRC	Reg in FE-base in plast-gambo e ghiera in FE zincocrom o otton <i>Non-tilt adjustable feet with plastic base and zinc-plated /brassed iron screw</i>	115
ITSQ	Puntale-copriresta quadro con testa tonda / <i>Square cover cap with round top</i>	22	PBRD	Reg in FE-base in plast-gambo e ghiera in FE zincocrom o otton <i>Non-tilt adjustable feet with plastic base and zinc-plated /brassed iron screw</i>	115
IVC	Piedino regol. quadro con base ottagonale / <i>Adjustable foot with octagonal base</i>	121	PBZ	Piede reg in PE nero con base zigrinata - gambo in FE zincocromato <i>Adjustable foot in PE with zinc-plated bolt</i>	119
IVC	Piedino regolabile quadro con base rotonda con esagono <i>Square adjustable foot with round base</i>	121	PC	Paracolpi con chiodo in PVC / <i>Buffer with nail in PVC</i>	60
IVR	Piede regolabile con base esagonale <i>Adjustable foot with hexagonal base</i>	122	PCP	Poggiapiani con chiodo passante in PS antiurto <i>Holder shelf in PS with nail passing</i>	98
MAC	Manopole per carrie in PE / <i>Handle for wheelbarrow in PE</i>	44	PCR	Regolabili cilindrici con base in PE nero e gambo in FE zincocromato <i>Non-tilt adjustable cylindrical feet with black PE base and zinc-plated iron screw</i>	116
MAL	Manopola liscia in PVC / <i>Smooth handle in PVC</i>	44	PCS	Passacavo per scrivania in PS/ <i>Cable ducts for desk in PS</i>	85
MCE	Maniglia curva ellittica in PP/ <i>Curved elliptical handle in PP</i>	103	PCSO	Puntali copriresta semiovali in PE <i>Ribbed half-oval insert in PE</i>	30
MCL	Maniglia curva larga in PP/ <i>Wide curved handle in PP</i>	103	PDBT	Piedino da avvitare a base triangolare/ <i>Triangular foot</i>	130
MDA	Maniglia in ABS/ <i>Handle in ABS (in thermosetting composition)</i>	102	PEE	Puntale esterno ovale in PVC / <i>Outer oval cap in PVC</i>	39
MDB	Maniglia in ABS/ <i>Handle in ABS (in thermosetting composition)</i>	102	PEO	Puntale esterno ovale in PVC / <i>Outer oval insert in PVC</i>	38
MDC	Maniglia in ABS/ <i>Handle in ABS</i>	104	PEP	Puntale esterno per piatto in PVC / <i>Angle insert in PE</i>	41
MF	Maniglia a filo in PP/ <i>Thread handle in PP</i>	103	PF1	Testa rotonda / <i>Round head buffer</i>	56
MI	Maniglia nera in PS antiurto/ <i>Shock proof handle in PS</i>	105	PF10	Paracolpi testa bombata in PVC / <i>Round head buffer in PVC</i>	59
MIR	Maniglia rotonda in PS antiurto interno liscio/ <i>Round handle, shock proof in PS</i>	105	PF12	Paracolpi con piolini in PVC/ <i>Buffer with posts in PVC</i>	59
MIS	Maniglia a scatto in PS antiurto/ <i>Flick handle, shock proof in PS</i>	105	PF13	Paracolpi rotondi in PVC / <i>Round buffers in PVC</i>	57
MMC	Maniglia mobili curva in PP/ <i>Curved handle in PP</i>	103	PF14	Paracolpi a tronco di cono in PE / <i>Conical buffer in PE</i>	57
MML	Maniglietta in PP/ <i>Handle in PP</i>	104	PF15	Paracolpi con gambo in PE bianchi / <i>White insert with bolt in PE</i>	58
MOB	Maniglia ovale in PS antiurto nera <i>Oval handle in PS (in thermosetting composition)</i>	102	PF16	Paracolpi con 2 gambi in PE bianchi / <i>White insert with 2 bolts in PE</i>	58
MR	Mensola reggipiano in PA neutro/ <i>Shelf in neutral PA</i>	87	PF2	Testa bombata / <i>Round head buffer</i>	56
MRS	Mensola reggipiano a scatto per piani mm.15 in PS/ <i>Holder shelf in PS</i>	101	PF3	Testa piatta / <i>Flat head buffer</i>	56
MRT	Mensola reggitubo armadio in PS/ <i>Holder shelf for wardrobe pipe in PS</i>	100	PF3	Testa piatta trasparente in PVC <i>Transparent flat buffer in PVC</i>	57
MS	Borchia liscia per saldatura autogena in FE <i>Smooth iron stud for welding</i>	51	PF3B	Testa piatta in PE nero / <i>Transparent flat buffer in PE</i>	58
MSE	Borchia con sporgenza per saldatura elettrica in FE <i>Smooth iron stud for welding</i>	51	PF3B	Testa piatta trasparente in PVC / <i>Transparent flat buffer in PVC</i>	58
MSP	Base plastica in PE / <i>Round plastic snap insert in PE</i>	51	PF4	Testa rettangolare / <i>Rectangular head buffer</i>	57
MSS	Borchia testa sagomata in FE / <i>Flat stud in FE</i>	51	PF5	Testa bassa / <i>Low head buffer</i>	57
MSSP	Base plastica piana in PE / <i>Plastic insert in PE</i>	51	PF6	Paracolpi con chiodo testa rotonda in PE bianchi <i>Round head buffer with nail in PE</i>	60
MTT	Maniglia trapezoidale in PA <i>Trapezoidal handle in PA(in thermosetting composition)</i>	102	PF7	Paracolpi testa bombata in PVC / <i>Buffers with round head in PVC</i>	59
MXA	Mozzo per appendiabiti con copertina/ <i>Clothes-hook with cover</i>	68	PF8	Paracolpi con 2 chiodi in PE bianchi / <i>Buffer with double nail in PE</i>	60
OAF	Puntali ovali alettati filettati in PP/Ribbed oval threaded insert in PP	30	PF9	Paracolpi testa rotonda in PVC / <i>Round head buffer in PVC</i>	59
OIA	Puntali ovali alettati in PE / <i>Ribbed oval insert in PE</i>	29	PFB	Pinze ferma brande in PP / <i>Clips in PP</i>	63
OIADI	Puntale alettato inclinato 15° in PE / <i>Inclined 15° ribbed oval insert in PE</i>	29	PFB	Pinze ferma brande in PP neutro (1) / <i>Clip in neutral PP (1)</i>	62
OIAS	Puntale ovale alettato in PE / <i>Inclined oval ribbed insert in PE</i>	29	PFB	Pinze ferma brande in PP neutro (2) / <i>Clip in neutral PP (2)</i>	62
OTO40	Ruota Ø40 "OTO40"/ <i>Castor Ø40 "OTO40"</i>	152	PFGC	Prolunga per gamba cucine / <i>Extension for kitchen leg</i>	128
OTO40CF	Ruota Ø40 "OTO40" con freno/ <i>Castor Ø40 "OTO40" with brake</i>	152	PFM	Piedino fisso per mobiletti/ <i>Fixed glide for cabinets</i>	101
OTO40RG	Ruota Ø40 "OTO40" con gomma PA6/ <i>Castor Ø40 "OTO40" with rubber</i>	152	PFFA	Piedino per fissaggio panca / <i>Foot for bench fixing</i>	122
OTO50	Ruota Ø50 "OTO50"/ <i>Castor Ø50 "OTO50"</i>	151	PFS	Pomelli filettati sferici in ABS (1) <i>Ball knobs in ABS (1)</i>	69
OTO50CF	Ruota Ø50 "OTO50" con freno/ <i>Castor Ø50 "OTO50" with brake</i>	151	PFS	Pomelli sferici filettati in ABS (2) <i>Threaded knobs in ABS (2)</i>	107
OTO50RG	Ruota Ø50 "OTO50" con gomma/ <i>Castor Ø50 "OTO50" with rubber</i>	151	PGAM	Pompa a gas ante mobili / <i>Gas lift for wardrobe doors</i>	130
P2GL	Piedino per gambe legno in PE/ <i>Glide in PE for wooden legs</i>	101	PGO	Piastra per GPO spogliatoi in FE grezzo <i>Raw FE plate for umbrella stand</i>	78
P2P	Pinza a 2 pioli in PE / <i>Pillars two post in PE</i>	47	PGP	Poggiapiedi in PE/ <i>Foot-rest with holes for screws in PE</i>	84
P2PA	Pinza a 2 pioli in PE / <i>Pliers two post in PE</i>	47	PGS	Piedino per gambe scrivania / <i>Flat feet for desk</i>	117
P4P	Paracolpi 4 pezzi per stendibiancheria in PE / <i>Inserts in 4 pcs</i>	58	PGSI	Piedini snodati con base piana in PA <i>Tilt glide with base in PA</i>	126
PAP	Pomelli attaccapanni in ABS / <i>Ball knobs in ABS</i>	69	PGSR	Piede regolabile per gambe scrivania per tubo Ø 60 sp.1mm <i>Adjustable foot for desk legs for tube Ø 60 thickness 1 mm</i>	122
PAR	Piedino a 90° antiribaltamento in PP / <i>Feet 90° antiupsetting in PP</i>	48	PGT	Piede regolabile con esagono e vite girevole (base in PA nera o con ghiera cromata e gambo zincocromato) <i>Non-tilt adjustable screw (base in PA or chromed base and zinc-plated iron bolt)</i>	118
PARP	Piedino antiribaltamento in PP / <i>Anti-upsetting feet in PP</i>	48	PIC	Paracolpi con incavo cilindrici in PVC / <i>Cylindrical buffer with cavity in PVC</i>	54
PART	Piedino antiribaltamento per telaio slitta D25 <i>Anti-upsetting feet for cantilever D25</i>	48	PIO	Puntali ovali inclinati 12,5° in PE / <i>Inclined ribbed oval insert 12,5 in PE</i>	30
PAS	Piastra aggancio attaccapanni spogliatoio in FE cromato <i>Chrome FE plate for cloth hanger</i>	78	PIO	Puntali ovali inclinati alla base 20° e gambo 30° in PE <i>Ribbed oval insert inclined bottom 20° leg 30° in PE</i>	30
PASA	Piede piatto-Attacco sagom.Ø11 - Diritto Ø10 / <i>Flat feet in PA zinc-plated Ø 10-11</i>	117	PIT	Distanziatore con incavo / <i>Buffer with cavity</i>	54
PAT	Protezione aletta thonet in PE / <i>Protection thonet fin in PE</i>	44			
PATC	Pomelli attaccapanni neri in PS con testa in FE cromata o ottonata <i>Black knobs-PS-chromed or brass head</i>	70			
PATS	Piedino anteriore per telaio slitta D25/ <i>Front feet for cantilever D25</i>	48			

PMS	Paraspigolo a sezione per mobili in PE /Sectional cover corner for furniture in PE	45
PMU	Piedino per mobili regolabile con base snodata- Piedino,dado,base, forniti montati Adjustable tilt glide for furniture-Adjustable foot,bolt and base supplied assembled	121
PMU4	Kit 4 piedini per mobili regolabili con base snodata. Kit of four adjustable feet with tilt base for furniture	121
PMUC	Piedino per mobili regolabili con base snodata /Adjustable tilt glide for furniture	121
POB2	Puntale est. ovale con base inclin. in PVC Oval insert with inclined base in PVC	38
POC	Pomello con testa incavata in ABS filettati 4MA Knob with sunken head in ABS thread 4MA	106
PODI	Vaschetta Portadocumenti Impilabile/ Stackable document tray	94
POMC	Pomello concavo per mobili/ Knob with concave head	106
POR	Pomello rotondo in PS / Round knobs in PS	107
PORB	Base portaombrelli / Umbrella-stand base	75
POS	Porta oggetti cassetti scrivania in PS/ Objects-trayer for desk in PS	89
POSF	Porta oggetti cassetti scrivania con fermo in PS Objects-trayer with blocking in PS	89
POSG	Porta oggetti cassetti scrivania in PS/ Objects-trayer for desk in PS	90
POSGF	Porta oggetti cassetti scrivania con fermo in PS/ Objects-trayer for desk in PS	90
POSGL	Porta oggetti cassetti scrivania con fermo in PS/Objects-trayer with blocking in PS	90
POSGS	Portaoggetti cassetti scrivania con fermo in PS/Objects-trayer with blocking in PS	91
POSL	Porta oggetti cassetti scrivania in PS/ Objects-trayer for desk in PS	89
POSR	Portaoggetti con cassetto regolabile per scrivania Objects-trayer with adjustable drawing for desk	91
PP	Paracolpi con chiodo e pattino in FE cromato /Buffer with nail and chrome top	61
PPDA	Piedino per divano in acciaio inox / Stainless steel foot for sofa	130
PPG	Profilato rotondo in PVC rigido Profile cover in rigid PVC	84
PPL	Puntali per piedi letto in PE / Insert in PE	37-65
PPML	Piedino per meccanismo letto/Adjustable foot for bed mechanism	120
PPP	Paracolpi con chiodo e pattino in plastica /Buffer with nail and plastic top	61
PPS	Pomolo per appendiabito in ABS / Knob for cloth hanger in ABS	69
PPTF	Prolunga per piedini con aggancio per telaio a filo neutro (per BTFA) Neutral joint for glides BTFA	34
PQ	Paracolpi quadri neri in PVC / Square insert in PVC	55
PQR	Profilato quadro e rettangin PVC rigido Rectangular square cover profile in rigid PVC	85
PR	Perno per rotella RC in PA colore neutro/ Pivot for castors in neutral PA	87
PRA	Reg in FE-base in plast-gambo e ghiera in FE zincocrom o ottonati Non-tilt adjustable feet with plastic base and zinc-plated /brassed screw	113
PRB	Reg in FE-base in plast-gambo e ghiera in FE zincocrom o ottonati Non-tilt adjustable feet with plastic base and zinc-plated /brassed screw	113
PRBG	Piede reg-base grande e esagono mm20 in PA-gambo in FE zincocrom Adjustable foot in PA with big base and hexagonal mm.20 - zinc-plated bolt	120
PRC	Reg in FE-base in plast-gambo e ghiera in FE zincocrom o ottonati Non-tilt adjustable feet with plastic base and zinc-plated /brassed /screw	114
PRD	Reg in FE-base in plast con gambo e ghiera in FE zincocrom o ottonati Non-tilt adjustable feet with plastic base and zinc-plated /brassed /screw	114
PREG	Piede regolabile in PP per vite in FE testa esagonale UNI 5739 Iron non-tilt adjustable feet for screws with hexagonal head UNI 5739	114
PREP	Pied reg con base piccola-esag mm20 in PA-gambo in FE zincocromato Adjustable foot in PA with small base and exagon mm.20 with zinc-plated bolt	120
PRG	Piedi reg con vite girev a testa esag mm.17 e gambo FE zincocromato Non-tilt adjustable feet (base in PA and zinc-plated iron bolt)	118
PRGB	Piede reg con vite girevole a testa esag mm.17 (base e vite in FE zinco-crom) Adjustable feet with revolving screw and hexagonal head mm.17-(base and screw in zinc-plated iron)	118
PRGC	Piede regol con vite girevole a testa esagonale mm.17-Con base e vite FE zincocromate. - PRGB - PRGC - a richiesta si può variare filetto e lunghezza gambi. Adjustable feet with revolving screw and exagonal head mm.17- With base and screw in zinc-plated FE PRGB - PRGC - it is possible to change the thread and the length of bolts iron on demand	118
PRM	Paraspigoli per mobili in PE / Cover corner for furniture in PE	45
PRM	Paraspigoli per mobili in PE / Cover corner for furniture in PE	45
PRMS	Paraspigolo sagomato per mobili in PE Corner cover for furniture in PE	45
PRMT	Paraspigolo triangolare / Triangular corner cover	45
PRP	Regolabili con base in PE nero e gambo in FE zincocromato Non-tilt adjustable feet with black PE base and zinc-plated iron screw	115
PRS	Piede regolabile stampato in PA/Non-tilt adjustable feet in PA	116
PS	Con base piana rigata in PE -ghiera in FE crom-gambo in FE zincocrom Adjustable tilt glide in PE and chromed zinc-plated iron screw	123
PSA	Con base bombata liscia in PE / With chromed convex smooth base	123
PSAO	Piedi scala artiglio in PVC / Ladder oval feet in PVC	39
PSAR	Piedi scala artiglio in PVC / Ladder feet in PVC	39
PSB	Con base bombata ricoperta in FE cromato /With chromed convex smooth base	123
PSC	Con base piana rigata / With plane striped base	123
PSD	Con base piana rigata / With plane striped base	123
PSE	Piedi snodati con esagono 10 / Tilt glide with hexagon 10 mm	124
PSE4	Piedi snodati e base in PE piana rigata / Tilt glide and plane-striped base in PE	125
PSE5	Con base bombata rivestita in FE crom / Tilt glide with chromed convex base in Fe	125
PSE8	Con base bombata in PE liscia/Tilt glide with convex base in PE	125
PSE9	Piedini snodati con base piana /Tilt glide with plane base	125
PSE9F	Piedi snodati con base piana in PP pattino in feltro Tilt glides with plane PP base and felt skid	125
PSEP	Piedi snod-base piana PA nera-gambo esag mm 10 in FE zincocromato Tilt glide with plane base in PA and zinc-plated iron bolt hexagon 10 mm	126
PSF	Con base piana in PP nero e gambo in FE zincocromato With plane black PP base and zinc-plated iron bolt	124
PSG	Piedi snodati con esagono 10 / Tilt glide with hexagon 10 mm	124
PSGA	Piedi snodati con base e gambo alettato in PP Tilt glide with base and ribbed stem in PP	126
PSGC	Piedino sottomobile con gamba per cucine / Foot insert for kitchen leg	129
PSH	Base in PP nero gambo con esagono 10 / Black base in PP with hexagon 10 mm	124
PSL	Protezione scocche legno in PVC / Protection for wooden chairs in PVC	49
PSP	Piedi scala a pera in PVC / Ladder insert in PVC	39
PSPO	Puntali scala a pera ovali in PVC / Ladder oval feet in PVC	40
PSRS	Reg snod Ø80 per scrivania con gambo esag CH 17 per tubo Ø50 sp.1.5 Adj. tilt glide Ø80 for desk with hexagon. thread CH17 for tube Ø50 thickness 1.5	126
PT	Paracolpi troncoconici in PVC / Cone buffer in PVC	54
PTF	Protezione per telaio ovale/ Protection for oval tube frame	49
PTGC	Piedino a terra filettato per gambe cucina / Threaded flor glide for kitchen leg	128
PTL	Puntale testa larga Ø40 per tubo spess.1 / Big head insert Ø40 with thickness 1 mm	12-65
PTT	Protezione per telaio tondo / Protection for round tube frame	49
PU01	Base porta ombrelli TREE / Umbrella stand base tree	75
PUS	Pinza unione sedie per tubo ovale in PP nero / Clips for oval tube in black PP	63
QAF	Puntali quadri filettati e alettati in PP / Threaded square ribbed inserts in PP	21
QAI	Puntali quadri alettati inclinati 30° in PE / Inclined square inserts 30°	21
QI	Puntali quadri in PVC / Square inserts in PVC	21
QIA	Puntali quadri alettati in PE / Square inserts in PE	20
QIAS	Puntali quadri alettati in PE / Square inserts in PE	20
QIZ	Puntali quadri inclinati 10° alettato a zoccolo in PE Inclined ribbed square inserts 10° in PE	21
RA	Reggiaste in PS antiurto/ Shelf supports in PS	98
RAF	Puntali rettangolari alettati e filettati in PP / Threaded and ribbed insert in PP	25
RAFI	Puntali rettangolari in PP con inserto filettato in ferro Square insert in PP with iron thread	26
RAI	Puntali rettangol alettati inclin. in PE / Inclined ribbed rectangular inserts in PE	25
RAP	Reggi aste con pioli in PE / Rod-trayer with peg in PE	65
RAPAL	Reggi aste arcuato con pioli in PE / Arched rod-trayer with peg in PE	65
RAR	Reggi aste rettangolare in PE nero / Rectangular rod-trayer in black PE	64
RBA	Piedi reg base alta PA nero-impronta per chiave esag per avvitamem Non-tilt adjustable hfeet with black PA base for hexagonal screwing	116
RBS	Riduzione per basi cono Ø 50 completa di ghiera Reduction for base cone Ø 50 complete with ring	97
RBSL	Riduzione per basi cono Ø 50 senza linguetta di smontaggio Reduction for base cone Ø 50 with disassembling tongue	97
RBSS	Riduzione per basi cono Ø 50 con linguetta di smontaggio Reduction for base cone Ø 50 without disassembling tongue	97
RBV	Riduttore per bloccaggio viti in PE/ PE adapter for the blocking of screws	81
RC	Rotelle cassetti in PA/Drawer castors in PA (Suitable for drawers and etc.)	86
RFR	Regolabili in FE con base ricoperta in PE Iron non-tilt adjustable feet with base covered in PE	114
RIA	Puntali rettangolari alettati in PE / Rectangular ribbed inserts in PE	24
RIAS	Puntale rettangolare sagomato in PE / Rectangular shaped insert in PE	25
RIZ	Puntali rett.inclinato 30° alettati a zoccolo in PE Inclined ribbed rectangular inserts 30° in PE	25
RL	Reggi lamiera ® Gambo per foro Ø 5 in PA neutro Metal support leg hole ø 5 in neutral PA	44
RMF	Rondelle per maniglia a filo in PP/ Washers in PP for thread handle	104
RML	Riduttore per perno godronato in PP/ Reducer for knurl pin in PP	81

RP	Rondelle paracolpi in PVC / Washers in PVC	55
RPM	Regolabili con pattini in acciaio/Adjustable feet with steel skid (Base in PA and zinc-plated bolt)	117
RPMG	Regolabile in PE con pattino e ghiera in FE gambo cromato Non-tilt adjustable feet in PE with metal-covered plastic base	117
RPN	Piede regolabile piatto / Non-tilt adjustable flat feet	116
RR	Riduttore alettato in PE per rotelle/ PE adapters for castors	80
RS	Rondelle sottoviti in HD e PE/ HD and PE washers	99
RSS	Rondella sottovite svasata in PA / Countersunk washer in PA	54
RTL	Rotella Libera Ø47/ Free-wheel Ø 47	145
SAGE	Supporto con aggancio per rete elettrosaldata / Support for the head of beds in PA	66
SAR35	Ruota Ø35 "SAR3"/ Castor Ø35 "SAR3"	153
SAR40	Ruota Ø40 "SAR4"/ Castor Ø40 "SAR4"	152
SARE	Supporto ad arco per rete elettrosaldata / Arched support for elecrowelded net	66
SGC	Sottomobile per gamba per cucine / Foot insert for kitchen leg	128
SP	Sottopiede a pinza in PE / Saddle feet in PE	46
SPL	Sottopiede a pinza lungo in PE / Saddle feet long type in PE	46
SPQ	Sottopiede pinza quadra 25X25 / Square feet pillar 25x25	46
SRPL	Supporto ruote per pannellicon 1 foro di fissaggio / One hole support for panels	149
STL	Supporto per testate letti in PA / Support for the head of beds in PA	66
STY	Puntale esterno in PP / Outer cap in PP	38
TC	Tubetti paracolpi ciechi in PVC/ Buffers in PVC	52
TD	Tubetto distanziatore in PE / Spacer in PE	52
TDI	Tubetti distanziatori con incavo in PE / Spacer in PE with cavity	53
TFS	Tappetino forato svuotato in PE / PE spacers	55
V30	Volantino a 3 punte ovale in PP con gambo in FE zincocromato Star knob in PP with zinc-plated bolt	110
VC	Vite per cuscinetti in FE zincato/ Zinc plated screw for bearings	86
VCF	Volant ciechi in PS antiurto con buccola in metallo filett serie a 6 lobi 6-8 lobe star blind knob in PS with metal threaded bush	111
VFP	Volantino con foro passante in PS con buccola metallo serie 8 lodi Star knob in PS with metal threaded bush	112
VG	Ventose con gambo forato in PVC / Buffers with drilled bolt in PVC	80
VGf	Volant gambo filett PS antiurto, 6-8 lobi gambo in FE zincocrom Star knobs with threaded bolt in PSs hock proof	108
VGJ	Volantino jolly in PP con gambo e battuta in FE zincocromato Star knob in PP with zinc-plated thread bolt	110
VIT	Vite per innesti ITR in FE zincocromato / Zinc plated screw for connectors ITR	72
VJA	Volant. jolly alto in PP-gambo in FE zincocrom/Star knob in PP-zinc-plated bolt	108
VJAB	Volantino jolly alto in PP-gambo in FE e bambo in FE zincocromato Star knob in PP with zinc-plated bolt	109
VJB	Volantino jolly basso in PP con gambo in FE zincocromato Star knob in PP with zinc-plated bolt	108
VJBB	Volant jolly basso in PP -battuta in FE -gambo in FE zincocromato Star knob in PP with zinc-plated bolt	108
VJF	Volantino Jolly basso in PP con buccola in metallo filettata Star knob in PP with metal threaded bush	112
VJS	Volant jolly (PP)-gambo FE zincocrom/Star knob (PP) -threaded zinc-plated bolt	109
VJSB	Volantino jolly in PP con battuta in FE/Star knob in PP with zinc-plated bolt	109
VLG	Vaschetta lavagna porta gesso in PP/ Chalk tray in PP	84
VPH	Piede reg in PE nero con base esagonale e gambo in FE zincocromato Adjustable foot in PE with hexagonal base and zinc-plated bolt	120
VPHA	Piede reg in PE nero con base esagonale e gambo in FE zincocromato Adjustable foot in PE with hexagonal base and zinc-plated bolt	119
VPHA	Volant/Piede reg in PE nero -base esag e gambo in FE zincocromato Adjustable knob/glide in PE with hexagonal base and zinc-plated bolt	111
VPO	Vaschetta porta ombrelli per spogliatoi in PP Umbrella tray in PP	78
VPR	Volantino -Piedino regolabile / Knob-adjustable glide	111-119
VS	Ventose con sfera in PVC/ Buffers with ball in PVC	80
VSE	Volantini sottopiastra economici in PP- gambo in FE zincocromato Star knob in PP with zinc-plated bolt	109
VSEB	Volant sottopiastra in PP -battuta in FE e gambo in FE zincocromato Star knob in PP with zinc-plated bolt	110
VTB	Volantino Twist in PP con gambo e battuta in FE zincocromato Star knob in PP with zinc-plated bolt	110
VZC	Volantino in PA -buccola in metallo filettata serie rotondo zigrinato Star knob in PA with metal threaded bush	112
VZF	Volant- gambo filett in PA- gambo in FE zincocrom rotondo zigrinato Knurled knob in PA with zinc-plated bolt	111

BTF-BTFA-PPTF Agganci per telaio/ Set 4 pcs of neutral glides for wireframes	35
Articoli per reti e letti / Articles for bed frames and nets	64-66
Articoli per attaccapanni e portaombrelli/ Items for clothes and umbrella stands	67
Assemblaggio innesto tubi/ Connector tube assembling	71-72
Articoli per spogliatoi/ Changing rooms items	77
Articoli per mobili scuola-ufficio/ School-office items	83
Portaoggetti regolabile per cassetto scrivania/ Adjustable object tray for desk	88
Cassetto portaoggetti/ Obhect tray	92
Vaschetta portadocumenti impilabile / Stackable document tray	94
Articoli medico ospedalieri(portaflabo)/ Hospital medical articles (drip bag trayer)	95
Piedini per cucine / Feet for kitchen furniture	127
Divano con piedini in acciaio inox mod. PPDA / Sofa with stainless steel foot mod. PPDA	130
ADP Agganci e distanziale per sedia a pozzetto / ADP Links and spacer for armchair	131
Supporto ruote per pannelli / Support for panels	148

## Note informative

### Articoli con lamierino cromato

In ottemperanza alle normative europee (RoHS) vi segnaliamo che saremo in grado di fornire gli articoli con finitura CROMATA lucida fino ad esaurimento scorte. In seguito, gli stessi articoli, saranno prodotti con del nastro NICHELATO lucido.

### Items with chrome sheet metal

In compliance with the European regulations (RoHS), we inform you that we will be able to supply shiny chromed articles till stocks last afterwards the same items will be produced with nickel plated tape.

A norma di legge è vietata la riproduzione, anche parziale, con qualsiasi mezzo effettuata, compresa la fotocopia, anche a uso interno o didattico, non autorizzata, del presente catalogo- Marchio registrato  
Unauthorised reproduction and/or distribution of the contents of this site in whole or in part by any means is strictly prohibited -Trade mark





IVARS SpA  
via Gargnà 23/a 25078  
Vestone (Bs) Italia  
Tel. +39 0365 878801  
Fax +39 0365 820000  
Email: [ivars@ivars.it](mailto:ivars@ivars.it)  
<http://www.ivars.it>